

Built-in connector enables downsizing and easier connection. Protective circuit for safe operation.

- A built-in connector minimizes the shape and dimensional requirements.
- Two outputs: light-ON and dark-ON.
- Complete lineup including seven different shapes.
- Safer operation with built-in power supply reverse polarity protection.
- Output overcurrent protection with a thermal shutdown circuit (patent pending). *1
- The indicator can be seen from many directions to enable installation in more locations.
- Connector with lock that mates with commercially available connectors. *2

*1. Output overcurrent protection is provided only on output 2 (OUT2) on NPN models.

*2. Recommended connector:
J.S.T. Mfg. Co., Ltd. Contacts: SPHD-001T-P0.5, Housing: PAP-04V-S
Ask the manufacturer of the connector for details.

 Be sure to read the **Safety Precautions** on page 5.

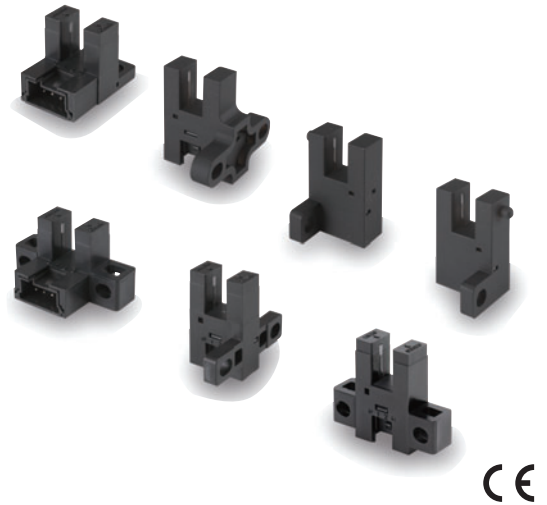

Features

Built-in Connector for Downsizing and Easier Connection

A built-in connector minimizes the shape and dimensional requirements. And wiring costs can be reduced by using commercially available connectors.

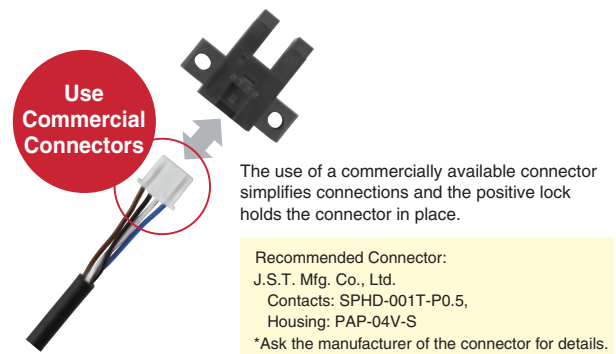
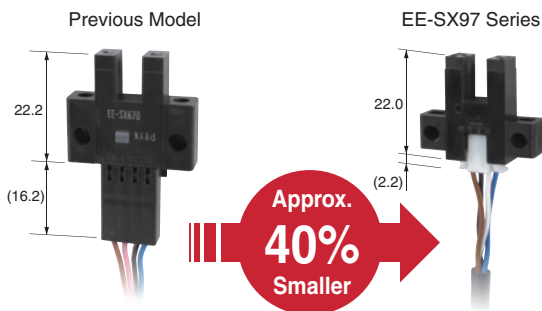

Safer Operation with Built-in Power Supply Reverse Polarity Protection

The built-in power supply reverse polarity protection protects against reverse connection of the power supply or outputs for safer operation at the assembly site.

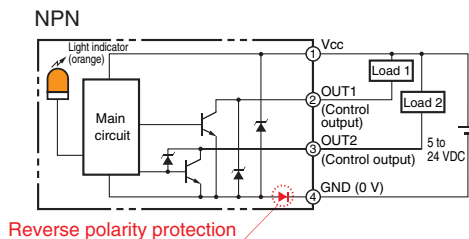

Built-in Thermal Shutdown Circuit

Control output 2 on models with NPN outputs is protected from output overcurrents by a built-in thermal shutdown circuit.

Easy-to-see Indicator

The indicator can be seen from up to four directions to enable installation in more locations.

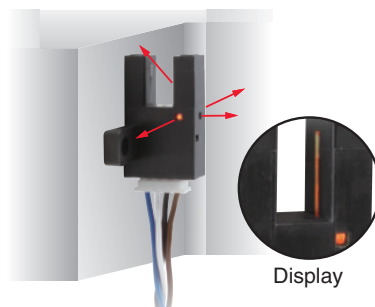









Two Outputs: Light-ON and Dark-ON

All models provide both a light-ON and dark-ON output so that the output can be switched according to the application simply by changing the wiring.

Ordering Information

Sensors

 Infrared light

Appearance	Sensing method	Connecting method	Sensing distance		Operating mode	Indicator mode	Model	
							NPN output	PNP output
Standard 	Through-beam type (with slot)	Connector model (4 poles)		5 mm (slot width)	Dark-ON/ Light-ON (2 outputs)	Incident light	EE-SX970-C1	EE-SX970P-C1
L-shaped 							EE-SX971-C1	EE-SX971P-C1
T-shaped, slot center 7 mm 							EE-SX972-C1	EE-SX972P-C1
Close-mounting 							EE-SX974-C1	EE-SX974P-C1
T-shaped, slot center 10 mm 							EE-SX975-C1	EE-SX975P-C1
F-shaped 							EE-SX976-C1	EE-SX976P-C1
R-shaped 							EE-SX977-C1	EE-SX977P-C1

Accessories (Order Separately)

Type	Cable length	Model
Connector with Cable	1 m	EE-1017 1M
	3 m	EE-1017 3M
Connector with Robot Cable	1 m	EE-1017-R 1M
	3 m	EE-1017-R 3M

Ratings and Specifications

Item	Type	Standard	L-shaped	T-shaped, slot center 7 mm	Close-mount- ing	T-shaped, slot center 10 mm	F-shaped	R-shaped
	NPN	EE-SX970-C1	EE-SX971-C1	EE-SX972-C1	EE-SX974-C1	EE-SX975-C1	EE-SX976-C1	EE-SX977-C1
	PNP	EE-SX970P-C1	EE-SX971P-C1	EE-SX972P-C1	EE-SX974P-C1	EE-SX975P-C1	EE-SX976P-C1	EE-SX977P-C1
Sensing distance		5 mm (slot width)						
Sensing object		Opaque: 2 × 0.8 mm min.						
Differential distance		0.025 mm max. *1						
Light source (Peak wave-length)		Infrared LED with a peak wavelength of 940 nm						
Indicator		Light indicator (orange LED)						
Supply voltage		5 to 24 VDC ±10%, ripple (p-p): 10% max.						
Current consumption		21 mA max.						
Control output		Load power supply voltage: 5 to 24 VDC, Load current: 50 mA max., Off-state current : 0.5mA max, 50 mA load current with a residual voltage of 1.0 V max., 5 mA load current with a residual voltage of 0.4 V max.						
Protection circuit		Power supply reverse polarity protection; output reverse polarity protection; overcurrent protection (only OUT2 on models with NPN output)						
Response frequency		1 kHz min. (3 kHz average) *2						
Ambient illumination		1,000 lx max. with fluorescent light on the surface of the receiver						
Ambient temperature range		Operating: -25 to 55°C Storage: -30 to 80°C (with no icing or condensation)						
Ambient humidity range		Operating: 5% to 85% Storage: 5% to 95% (with no icing or condensation)						
Vibration resistance (De-struction)		10 to 2,000 Hz 0.75-mm single amplitude (15-min periods, 10 cycles) each in X, Y, and Z directions						
Shock resistance (De-struction)		Destruction: 500 m/s ² for 3 times each in X, Y, and Z directions						
Degree of protection		IEC 60529 IP50						
Connecting method		Connector						
Weight (Packed state)		Approx. 3 g						
Mate- rial	Case/Cover	Polybutylene terephthalate (PBT)						
	Emitter/receiver	Polycarbonate (PC)						

*1. The differential distance is the value when a sensing object is moved in a lateral direction to the slot.

*2. The response frequency was measured by detecting the following rotating disk.

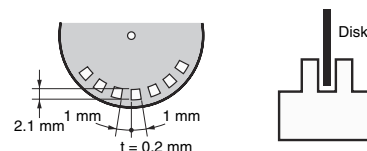

Connector

Item	Product Model	Connector with Cable	Connector with Robot Cable
	Appearance	EE-1017	EE-1017-R
Contact resistance		25 mΩ max. (at 10 mA DC and 20 mV max.)	
Insertion strength		20 N max.	
Surplus strength		1.5 N min.	
Cable length		1 m, 3 m	
Ambient temperature range		-10 to +60°C	
Materials	Housing	Nylon	
	Contact	Phosphor bronze	

Engineering Data (Typical)

Sensing Position Characteristics

Sensing Position Characteristics

Repeated Sensing Position Characteristics

EE-SX970

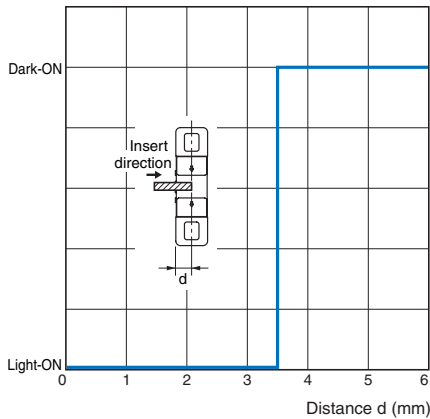

EE-SX970

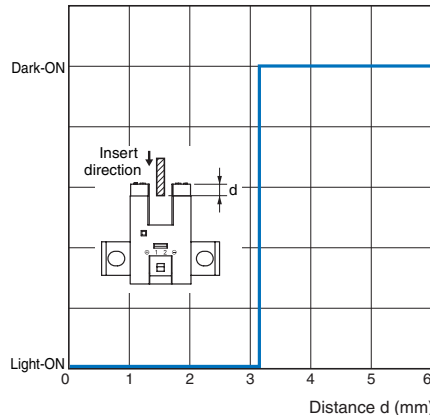

EE-SX970

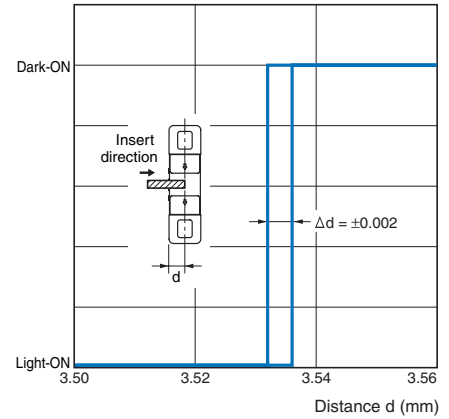

Vcc = 24 V, No. of repetitions: 20, Ta = 25°C
Differential distance = 0.025 mm max.

Note: Data is provided for dark conditions. Light interference and the translucence of the sensing object can affect operation.

I/O Circuit Diagrams

Output configuration	Model	Output transistor operation status	Timing charts	Output circuit
NPN output	EE-SX970-C1 EE-SX971-C1 EE-SX972-C1 EE-SX974-C1 EE-SX975-C1 EE-SX976-C1 EE-SX977-C1	OUT1: Light-ON OUT2: Dark-ON	Light incident Light interrupted Light indicator (orange) ON OFF Output 1 transistor ON OFF	<p>Connector pin arrangement</p>
	EE-SX970P-C1 EE-SX971P-C1 EE-SX972P-C1 EE-SX974P-C1 EE-SX975P-C1 EE-SX976P-C1 EE-SX977P-C1		Load 1 Operates (relay) Releases Output 2 transistor ON OFF Load 2 Operates (relay) Releases	<p>Connector pin arrangement</p>

Safety Precautions

Refer to Warranty and Limitations of Liability.

WARNING

This product is not designed or rated for ensuring safety of persons either directly or indirectly. Do not use it for such purposes.



Precautions for Safe Use

● Operating Environment

These Photomicrosensors have an IP50 (conforms to IEC) enclosure and do not have a water-proof or dust-proof structure. Therefore, do not use them in applications in which the sensor will be subjected to splashes from water, oil, or any other liquid. Liquid entering the Sensor may result in malfunction.

Precautions for Correct Use

Make sure that this product is used within the rated ambient environment conditions.

● Installation

- Mount the Sensor with two M3 screws, using plain washers and spring washers to ensure the screws will not become loose. Use a tightening force of 0.54 N·m max.

● Wiring

Unused Output Lines

Be sure to isolate output lines that are not going to be used.

Wiring method

Connection is made using a connector. Do not solder to the pins (leads). The pins (leads) are soldered to the internal board of the Sensor. Therefore, direct soldering of the pins (leads) may result in an internal disconnection causing malfunction.

● Others

- The power cable connected to the Sensor must not be more than 10 m in length.
- Only output 2 (OUT2) on NPN models is provided with overcurrent protection.

If an overcurrent occurs, heat generated by the output transistor will activate the thermal shutdown circuit and OUT2 will turn OFF. Check the wiring and load current and cycle the power supply. If there is no overcurrent, normal operation will be resumed. (The thermal shutdown circuit will be activated again if there is an overcurrent.)

This function does not provide protection against load short circuits. If the electric power of the output transistor increases due to a load short-circuit or near load short-circuit, the Sensor may be damaged.

- An output pulse may occur when the power supply is turned ON depending on the power supply and other conditions. The operation of the Sensor will be stable 100 ms after turning ON the power supply.

Dimensions

Sensors

EE-SX970-C1
EE-SX970P-C1

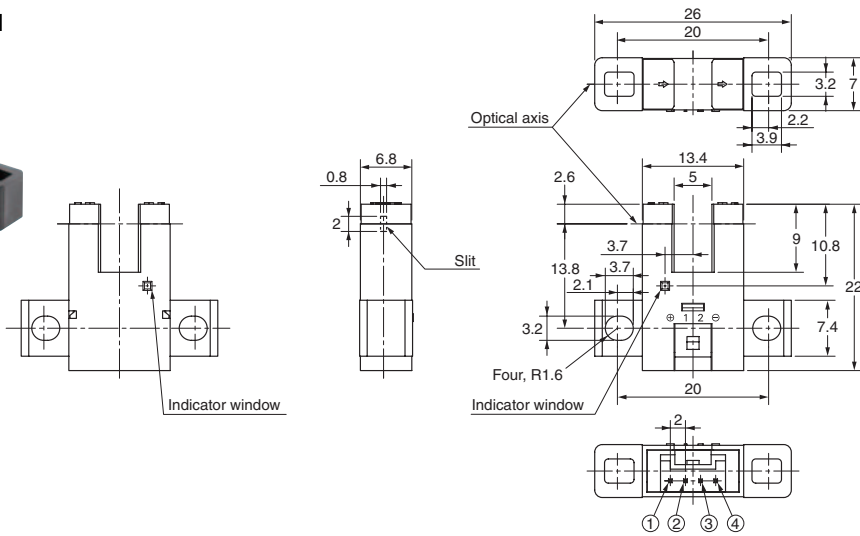

Terminal Arrangement

①	+	Vcc
②	1	OUTPUT1
③	2	OUTPUT2
④	-	GND (0 V)

Mounting screw holes

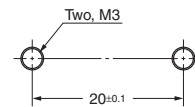

EE-SX971-C1
EE-SX971P-C1

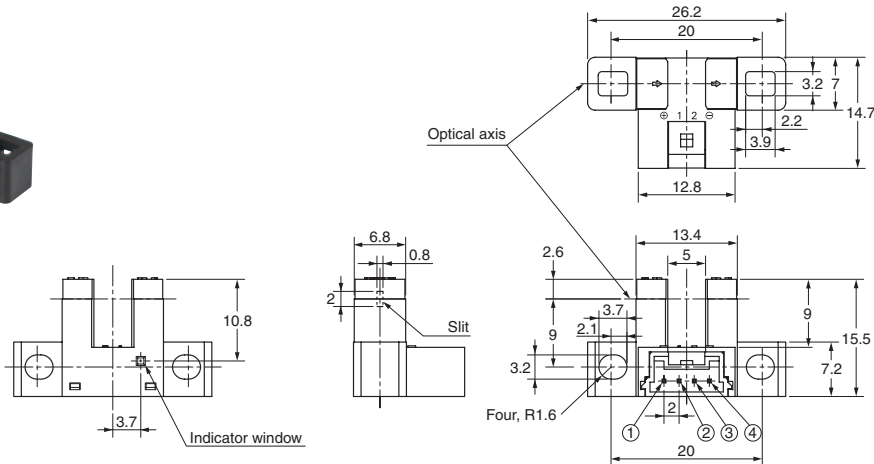

Terminal Arrangement

①	+	Vcc
②	1	OUTPUT1
③	2	OUTPUT2
④	-	GND (0 V)

Mounting screw holes



EE-SX972-C1
EE-SX972P-C1

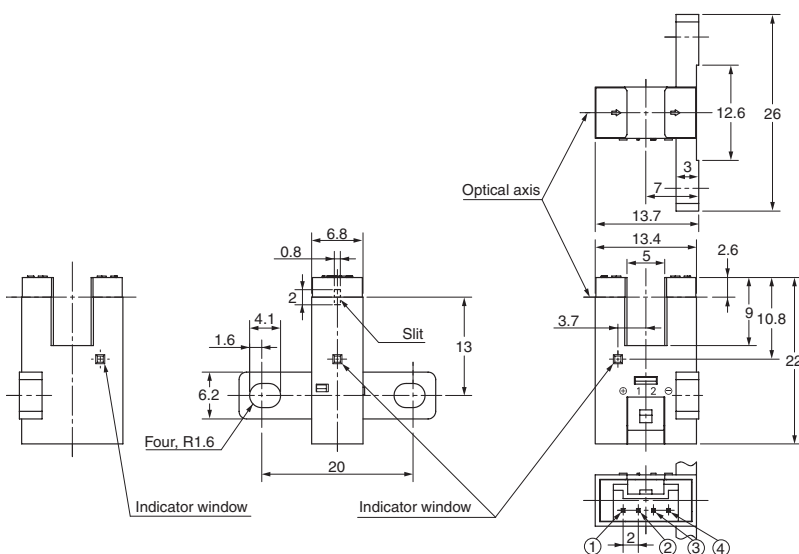

Terminal Arrangement

①	+	Vcc
②	1	OUTPUT1
③	2	OUTPUT2
④	-	GND (0 V)

Mounting screw holes

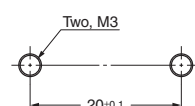

EE-SX977-C1
EE-SX977P-C1

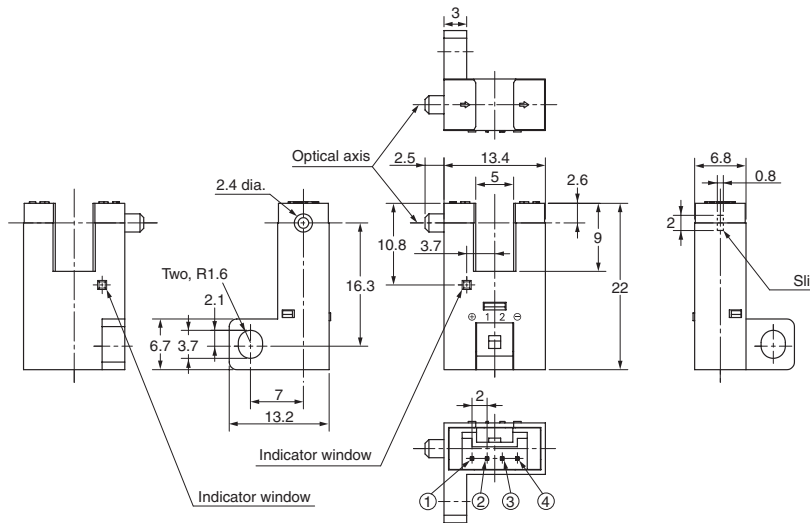

Terminal Arrangement

①	+	Vcc
②	1	OUTPUT1
③	2	OUTPUT2
④	-	GND (0 V)

Mounting screw holes

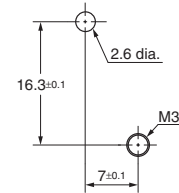

Accessories (Order Separately)

Connector

Connector with Cable

EE-1017

Connector with Robot Cable

EE-1017-R

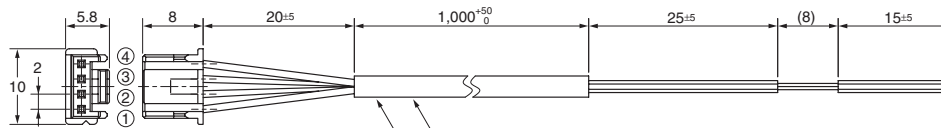

Connector with Cable: EE-1017
Vinyl insulated round cord: 4 dia., 4 cores,
(Cross section area of conductor: 0.2 mm²/ insulator: 1.1 mm dia.)

Connector with Robot Cable: EE-1017-R
Robot instrumentation cord: 4 dia., 4 cores,
(Cross section area of conductor: 0.2 mm²/ insulator: 1.1 mm dia.)

Terminal Arrangement

①	+	Brown
②	1	Black
③	2	White
④	-	Blue

Read and Understand This Catalog

Please read and understand this catalog before purchasing the products. Please consult your OMRON representative if you have any questions or comments.

Warranty and Limitations of Liability

WARRANTY

OMRON's exclusive warranty is that the products are free from defects in materials and workmanship for a period of one year (or other period if specified) from date of sale by OMRON.

OMRON MAKES NO WARRANTY OR REPRESENTATION, EXPRESS OR IMPLIED, REGARDING NON-INFRINGEMENT, MERCHANTABILITY, OR FITNESS FOR PARTICULAR PURPOSE OF THE PRODUCTS. ANY BUYER OR USER ACKNOWLEDGES THAT THE BUYER OR USER ALONE HAS DETERMINED THAT THE PRODUCTS WILL SUITABLY MEET THE REQUIREMENTS OF THEIR INTENDED USE. OMRON DISCLAIMS ALL OTHER WARRANTIES, EXPRESS OR IMPLIED.

LIMITATIONS OF LIABILITY

OMRON SHALL NOT BE RESPONSIBLE FOR SPECIAL, INDIRECT, OR CONSEQUENTIAL DAMAGES, LOSS OF PROFITS OR COMMERCIAL LOSS IN ANY WAY CONNECTED WITH THE PRODUCTS, WHETHER SUCH CLAIM IS BASED ON CONTRACT, WARRANTY, NEGLIGENCE, OR STRICT LIABILITY.

In no event shall the responsibility of OMRON for any act exceed the individual price of the product on which liability is asserted.

IN NO EVENT SHALL OMRON BE RESPONSIBLE FOR WARRANTY, REPAIR, OR OTHER CLAIMS REGARDING THE PRODUCTS UNLESS OMRON'S ANALYSIS CONFIRMS THAT THE PRODUCTS WERE PROPERLY HANDLED, STORED, INSTALLED, AND MAINTAINED AND NOT SUBJECT TO CONTAMINATION, ABUSE, MISUSE, OR INAPPROPRIATE MODIFICATION OR REPAIR.

Application Considerations

SUITABILITY FOR USE

OMRON shall not be responsible for conformity with any standards, codes, or regulations that apply to the combination of products in the customer's application or use of the products.

At the customer's request, OMRON will provide applicable third party certification documents identifying ratings and limitations of use that apply to the products. This information by itself is not sufficient for a complete determination of the suitability of the products in combination with the end product, machine, system, or other application or use.

The following are some examples of applications for which particular attention must be given. This is not intended to be an exhaustive list of all possible uses of the products, nor is it intended to imply that the uses listed may be suitable for the products:

- Outdoor use, uses involving potential chemical contamination or electrical interference, or conditions or uses not described in this catalog.
- Nuclear energy control systems, combustion systems, railroad systems, aviation systems, medical equipment, amusement machines, vehicles, safety equipment, and installations subject to separate industry or government regulations.
- Systems, machines, and equipment that could present a risk to life or property.

Please know and observe all prohibitions of use applicable to the products.

NEVER USE THE PRODUCTS FOR AN APPLICATION INVOLVING SERIOUS RISK TO LIFE OR PROPERTY WITHOUT ENSURING THAT THE SYSTEM AS A WHOLE HAS BEEN DESIGNED TO ADDRESS THE RISKS, AND THAT THE OMRON PRODUCTS ARE PROPERLY RATED AND INSTALLED FOR THE INTENDED USE WITHIN THE OVERALL EQUIPMENT OR SYSTEM.

PROGRAMMABLE PRODUCTS

OMRON shall not be responsible for the user's programming of a programmable product, or any consequence thereof.

Disclaimers

CHANGE IN SPECIFICATIONS

Product specifications and accessories may be changed at any time based on improvements and other reasons.

It is our practice to change model numbers when published ratings or features are changed, or when significant construction changes are made. However, some specifications of the products may be changed without any notice. When in doubt, special model numbers may be assigned to fix or establish key specifications for your application on your request. Please consult with your OMRON representative at any time to confirm actual specifications of purchased products.

DIMENSIONS AND WEIGHTS

Dimensions and weights are nominal and are not to be used for manufacturing purposes, even when tolerances are shown.

PERFORMANCE DATA

Performance data given in this catalog is provided as a guide for the user in determining suitability and does not constitute a warranty. It may represent the result of OMRON's test conditions, and the users must correlate it to actual application requirements. Actual performance is subject to the OMRON Warranty and Limitations of Liability.

ERRORS AND OMISSIONS

The information in this document has been carefully checked and is believed to be accurate; however, no responsibility is assumed for clerical, typographical, or proofreading errors, or omissions.

2010.12

In the interest of product improvement, specifications are subject to change without notice.

OMRON Corporation
Industrial Automation Company

<http://www.ia.omron.com/>

(c)Copyright OMRON Corporation 2010 All Right Reserved.

Компания «Life Electronics» занимается поставками электронных компонентов импортного и отечественного производства от производителей и со складов крупных дистрибьюторов Европы, Америки и Азии.

С конца 2013 года компания активно расширяет линейку поставок компонентов по направлению коаксиальный кабель, кварцевые генераторы и конденсаторы (керамические, пленочные, электролитические), за счёт заключения дистрибьюторских договоров

Мы предлагаем:

- Конкурентоспособные цены и скидки постоянным клиентам.
- Специальные условия для постоянных клиентов.
- Подбор аналогов.
- Поставку компонентов в любых объемах, удовлетворяющих вашим потребностям.
- Приемлемые сроки поставки, возможна ускоренная поставка.
- Доставку товара в любую точку России и стран СНГ.
- Комплексную поставку.
- Работу по проектам и поставку образцов.
- Формирование склада под заказчика.
- Сертификаты соответствия на поставляемую продукцию (по желанию клиента).
- Тестирование поставляемой продукции.
- Поставку компонентов, требующих военную и космическую приемку.
- Входной контроль качества.
- Наличие сертификата ISO.

В составе нашей компании организован Конструкторский отдел, призванный помогать разработчикам, и инженерам.

Конструкторский отдел помогает осуществить:

- Регистрацию проекта у производителя компонентов.
- Техническую поддержку проекта.
- Защиту от снятия компонента с производства.
- Оценку стоимости проекта по компонентам.
- Изготовление тестовой платы монтаж и пусконаладочные работы.



Тел: +7 (812) 336 43 04 (многоканальный)

Email: org@lifeelectronics.ru