

Applications

- Receiver Channel Protection
- Commercial and Military Radar

Product Features

- Frequency Range: 2 – 20 GHz
- Insertion Loss < 1.0 dB
- Return Loss > 12 dB
- Flat Leakage < 18 dBm
- Input Power CW Survivability up to 5W
- Integrated DC Block on both input and output
- Package Dimensions: 3.0 x 3.0 x 1.35 mm

General Description

TriQuint's TGL2208-SM is a packaged dual stage Limiter fabricated on TriQuint's proven GaAs VPIN process. Operating over 2 to 20 GHz, the TGL2208-SM has < 1dB of insertion loss under small signal operation and flat leakage of < 18 dBm under large signal input.

The TGL2208-SM is suitable for a variety of systems that require input protection for sensitive receive channel components.

The TGL2208-SM is available in a low-cost, surface mount 14 lead 3x3 AIN QFN package base with air cavity Liquid Crystal Polymer (LCP) lid. TGL2208-SM is ideally suited to support both commercial and defense related applications.

Lead-free and RoHS compliant.

Evaluation Boards are available upon request.



QFN 3x3mm 14L

Functional Block Diagram

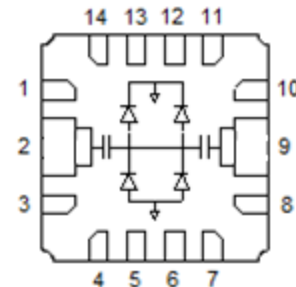

Pad Configuration

Pad No.	Symbol
1, 3, 8, 10	GND
2	RF IN/OUT
4 – 7, 11 - 14	N/C
9	RF OUT/IN

Ordering Information

Part	ECCN	Description
TGL2208-SM	EAR99	2- 20 GHz VPIN Limiter

Absolute Maximum Ratings

Parameter	Value
RF Input Power, CW, 50 Ω , T = 25 °C (P_{IN})	37 dBm
Mounting Temperature (30 Seconds)	260 °C
Storage Temperature	-55 to 150 °C

Operation of this device outside the parameter ranges given above may cause permanent damage. These are stress ratings only, and functional operation of the device at these conditions is not implied.

Recommended Operating Conditions

Parameter	Value
Passive - no bias	

Electrical specifications are measured at specified test conditions. Specifications are not guaranteed over all recommended operating conditions.

Electrical Specifications

Test conditions unless otherwise noted: 25 °C

Parameter	Min	Typical	Max	Units
Operational Frequency Range	2		20	GHz
Insertion Loss		0.5		dB
Input Return Loss		15		dB
Output Return Loss		15		dB
Flat Leakage Power @ Pin > 27dBm		18		dBm
Insertion Loss Temperature Coefficient		0.003		dB/°C

Typical Performance

Conditions unless otherwise specified: Passive – No Bias

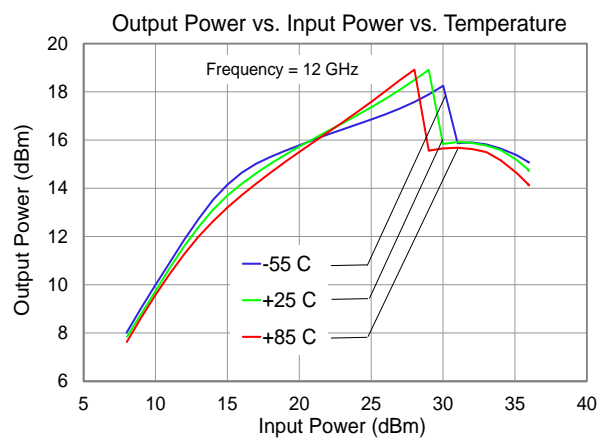
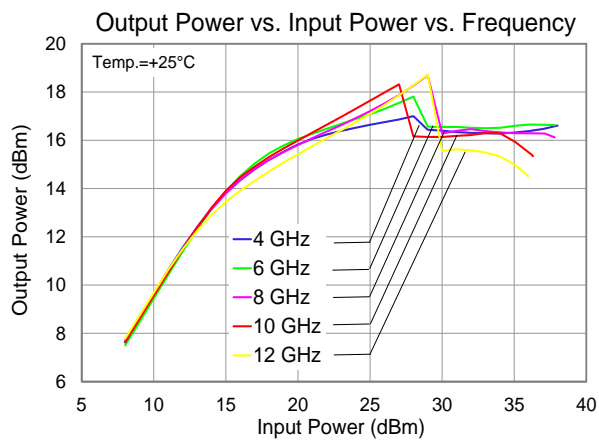
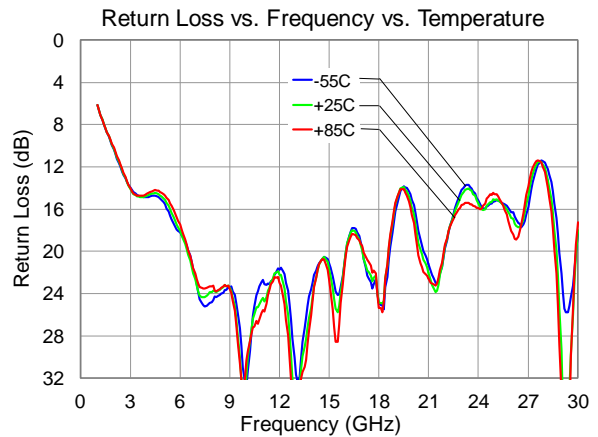
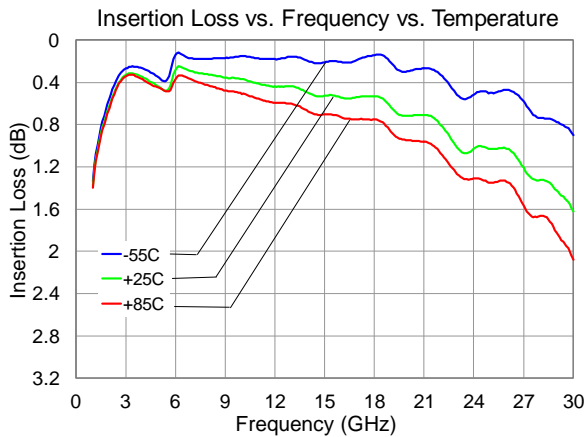

Application Circuit

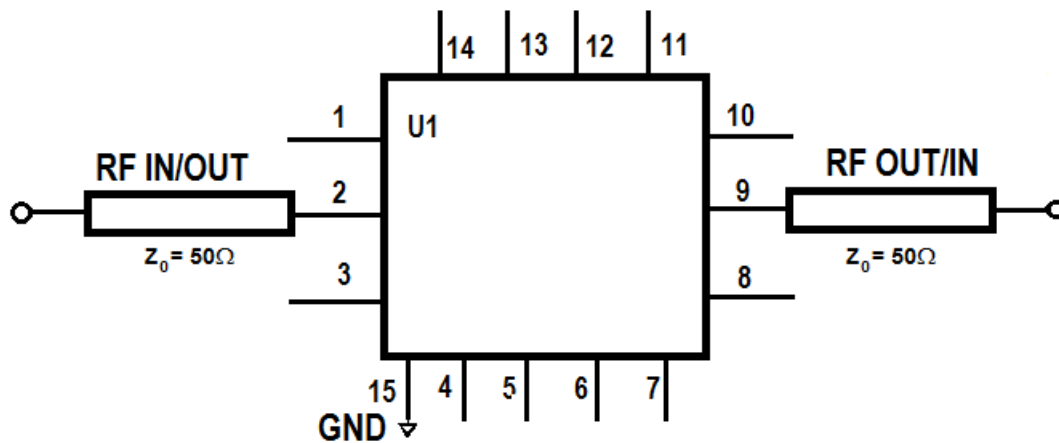

Notes: A heat sink is recommended for high power operation (RF input > 1 W)

Recommended Board Layout Assembly

Top RF layer is 0.010" thick Rogers RO4350

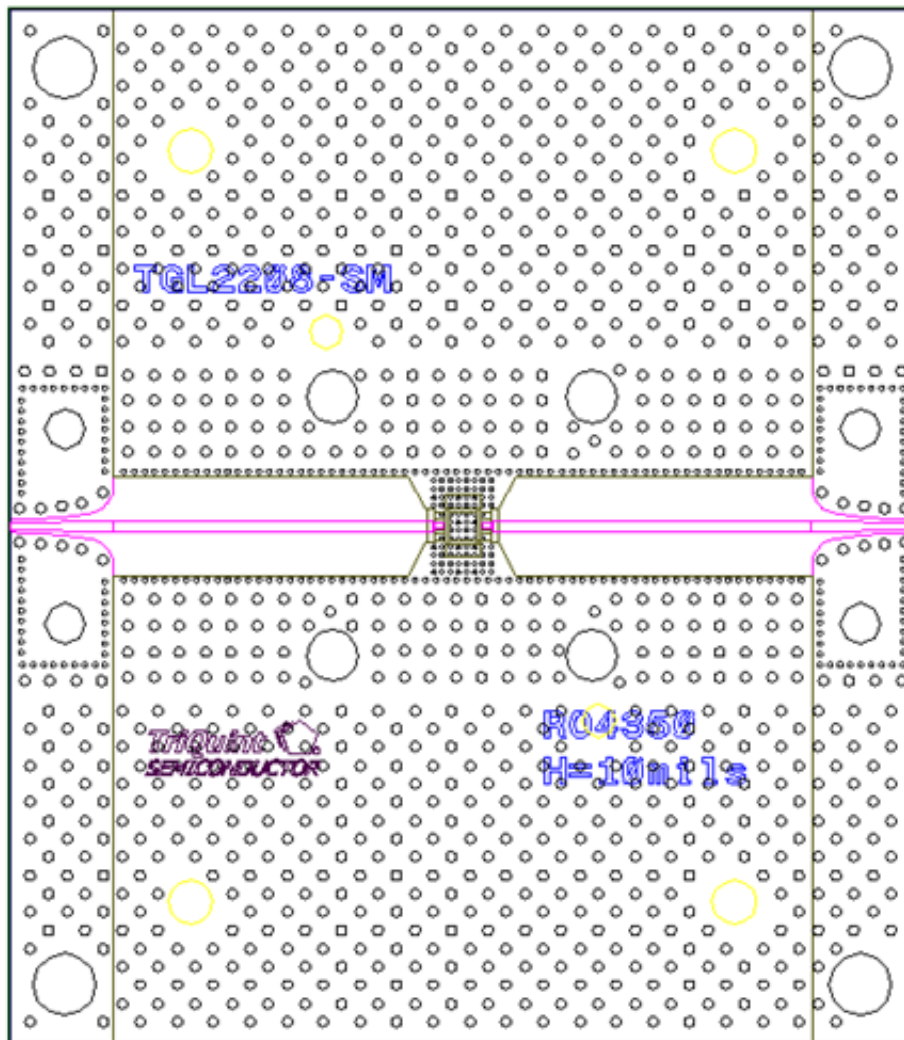

Pin Layout

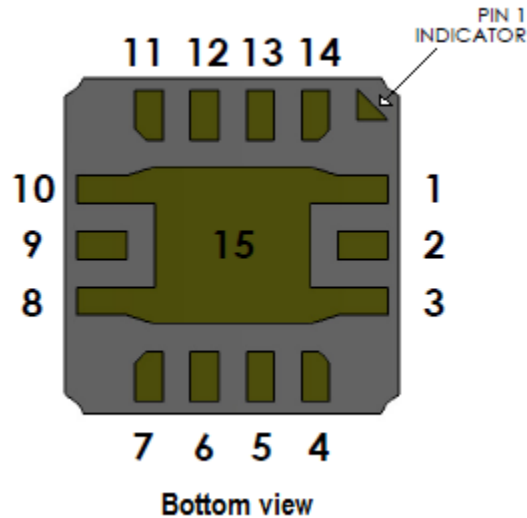

Pin Description

Pin	Symbol	Description
1, 3, 8, 10	GND	Pins 1,3,8 and 10 are connected to 15 (backside paddle) inside package.
2	RF IN/OUT	Input or Output, matched to 50 ohms
4 – 7, 11 - 14	N/C	No internal connection; must be grounded or left open on PCB
9	RF OUT	Output or Input, matched to 50 ohms
15	GND	On PCB, multiple vias should be employed under Pin 15 to minimize inductance and thermal resistance; see page 7 for suggested mounting configuration.

Mechanical Information

All dimensions are in inches. Unless specified otherwise, tolerances: ± 0.005 in.

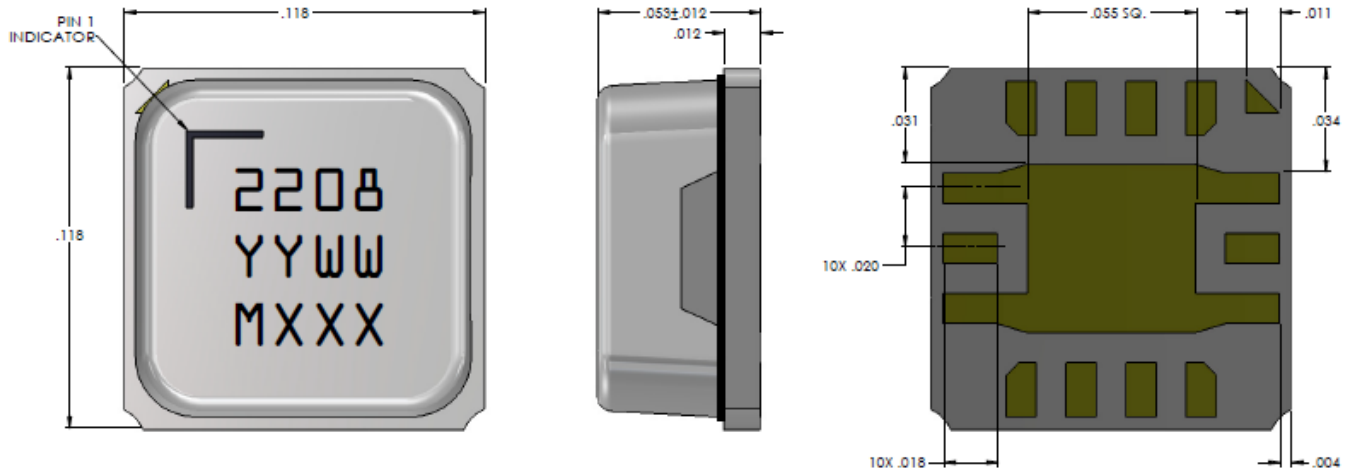

Marking: Part number – TGL2208
 Year/week code – YYWW
 Batch ID – MXXX

Package Materials:
 Base Aluminum Nitride (AlN)
 Lid Liquid Crystal Polymer (LCP)

Contact Pin Plating:
 Electroless Gold (Au) 0.5 – 1.5 μm
 over
 Electroless Nickel (Ni) 2.0 μm min.

PCB Mounting Pattern

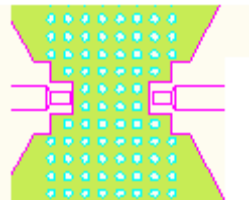

The pad pattern shown above has been developed and tested for optimized assembly at TriQuint. The PCB land pattern has been developed to accommodate lead and package tolerances. Since surface mount processes vary from company to company, careful process development is recommended.

Ground / thermal vias are critical for the proper performance of this device. Vias should use a 0.008 in. diameter drill, and they are solid filled, copper plated shut.

Product Compliance Information

ESD Sensitivity Ratings



Caution! ESD-Sensitive Device

ESD Rating: TBD
Value: TBD
Test: Human Body Model (HBM)
Standard: JEDEC Standard JESD22-A114

MSL Rating

Level 3 at +260 °C convection reflow
The part is rated Moisture Sensitivity Level 3 at 260°C per JEDEC standard IPC/JEDEC J-STD-020.

ECCN

US Department of Commerce: EAR99

Solderability

Compatible with the latest version of J-STD-020, Lead free solder, 260°C

RoHS Compliance

This part is compliant with EU 2002/95/EC RoHS directive (Restrictions on the Use of Certain Hazardous Substances in Electrical and Electronic Equipment).

This product also has the following attributes:

- Lead Free
- Halogen Free (Chlorine, Bromine)
- Antimony Free
- TBBP-A (C₁₅H₁₂Br₄O₂) Free
- PFOS Free
- SVHC Free

Recommended Soldering Temperature Profile

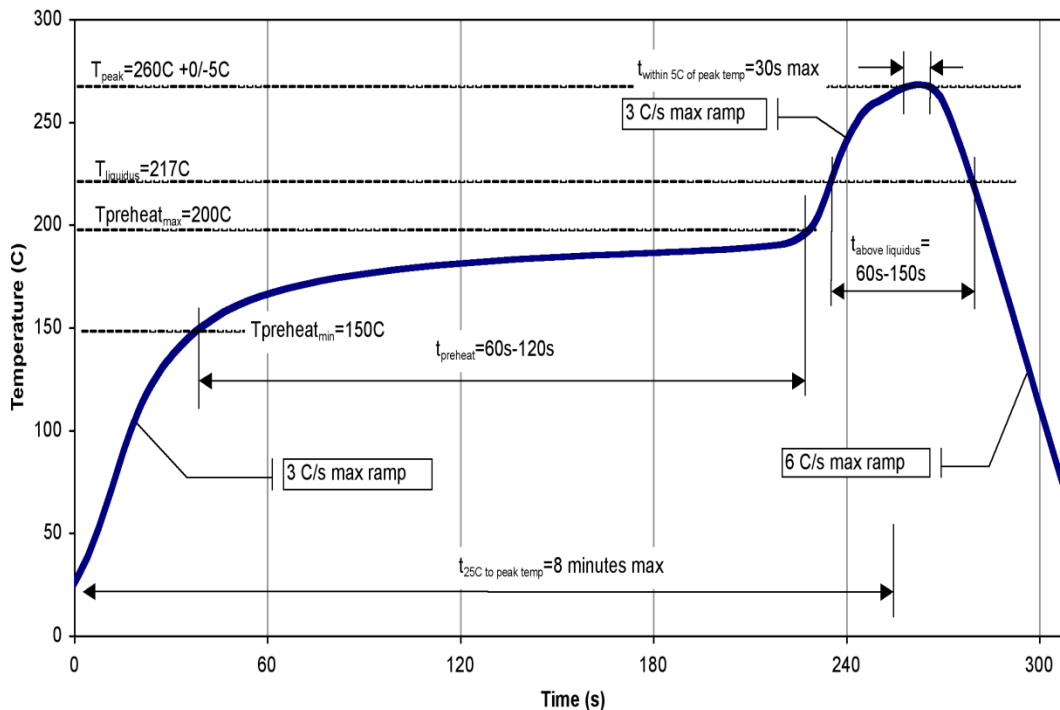

Contact Information

For the latest specifications, additional product information, worldwide sales and distribution locations, and information about TriQuint:

Web: www.triquint.com

Email: info-sales@triquint.com

Tel: +1.972.994.8465

Fax: +1.972.994.8504

For technical questions and application information:

Email: info-products@triquint.com

Important Notice

The information contained herein is believed to be reliable. TriQuint makes no warranties regarding the information contained herein. TriQuint assumes no responsibility or liability whatsoever for any of the information contained herein. TriQuint assumes no responsibility or liability whatsoever for the use of the information contained herein. The information contained herein is provided "AS IS, WHERE IS" and with all faults, and the entire risk associated with such information is entirely with the user. All information contained herein is subject to change without notice. Customers should obtain and verify the latest relevant information before placing orders for TriQuint products. The information contained herein or any use of such information does not grant, explicitly or implicitly, to any party any patent rights, licenses, or any other intellectual property rights, whether with regard to such information itself or anything described by such information.

TriQuint products are not warranted or authorized for use as critical components in medical, life-saving, or life-sustaining applications, or other applications where a failure would reasonably be expected to cause severe personal injury or death.

Компания «Life Electronics» занимается поставками электронных компонентов импортного и отечественного производства от производителей и со складов крупных дистрибьюторов Европы, Америки и Азии.

С конца 2013 года компания активно расширяет линейку поставок компонентов по направлению коаксиальный кабель, кварцевые генераторы и конденсаторы (керамические, пленочные, электролитические), за счёт заключения дистрибьюторских договоров

Мы предлагаем:

- Конкурентоспособные цены и скидки постоянным клиентам.
- Специальные условия для постоянных клиентов.
- Подбор аналогов.
- Поставку компонентов в любых объемах, удовлетворяющих вашим потребностям.
- Приемлемые сроки поставки, возможна ускоренная поставка.
- Доставку товара в любую точку России и стран СНГ.
- Комплексную поставку.
- Работу по проектам и поставку образцов.
- Формирование склада под заказчика.
- Сертификаты соответствия на поставляемую продукцию (по желанию клиента).
- Тестирование поставляемой продукции.
- Поставку компонентов, требующих военную и космическую приемку.
- Входной контроль качества.
- Наличие сертификата ISO.

В составе нашей компании организован Конструкторский отдел, призванный помогать разработчикам, и инженерам.

Конструкторский отдел помогает осуществить:

- Регистрацию проекта у производителя компонентов.
- Техническую поддержку проекта.
- Защиту от снятия компонента с производства.
- Оценку стоимости проекта по компонентам.
- Изготовление тестовой платы монтаж и пусконаладочные работы.



Тел: +7 (812) 336 43 04 (многоканальный)

Email: org@lifeelectronics.ru