

KTTWR17510EVBUG

TWR-17510EVB Tower System Platform

Rev. 1.0 — 2 August 2016

User guide

1 TWR-17510EVB

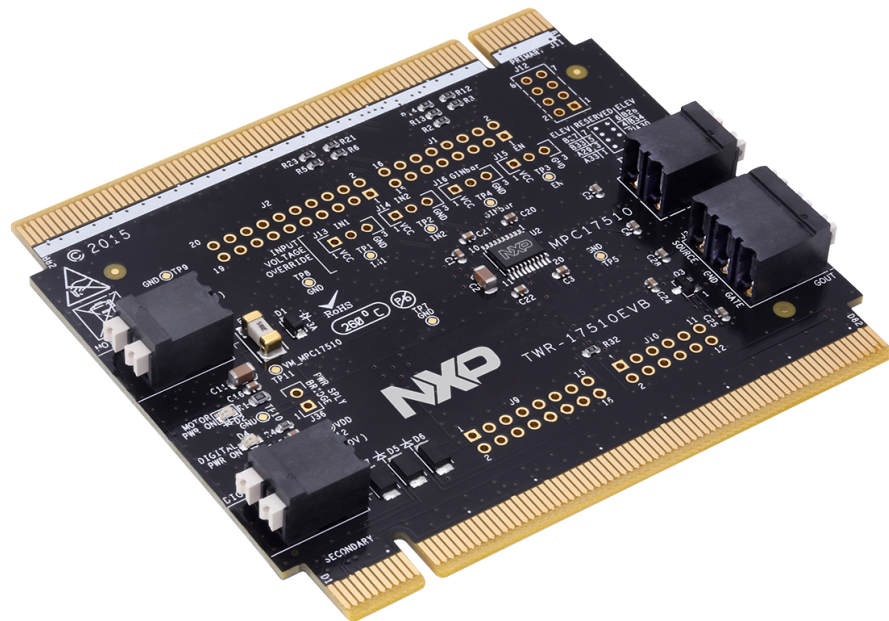

2 Important notice

NXP provides the enclosed product(s) under the following conditions:

This evaluation kit is intended for use of ENGINEERING DEVELOPMENT OR EVALUATION PURPOSES ONLY. It is provided as a sample IC pre-soldered to a printed circuit board to make it easier to access inputs, outputs, and supply terminals. This evaluation board may be used with any development system or other source of I/O signals by simply connecting it to the host MCU or computer board via off-the-shelf cables. This evaluation board is not a Reference Design and is not intended to represent a final design recommendation for any particular application. Final device in an application will be heavily dependent on proper printed circuit board layout and heat sinking design as well as attention to supply filtering, transient suppression, and I/O signal quality.

The goods provided may not be complete in terms of required design, marketing, and or manufacturing related protective considerations, including product safety measures typically found in the end product incorporating the goods. Due to the open construction of the product, it is the user's responsibility to take any and all appropriate precautions with regard to electrostatic discharge. In order to minimize risks associated with the customers applications, adequate design and operating safeguards must be provided by the customer to minimize inherent or procedural hazards. For any safety concerns, contact NXP sales and technical support services.

Should this evaluation kit not meet the specifications indicated in the kit, it may be returned within 30 days from the date of delivery and will be replaced by a new kit.

NXP reserves the right to make changes without further notice to any products herein. NXP makes no warranty, representation or guarantee regarding the suitability of its products for any particular purpose, nor does NXP assume any liability arising out of the application or use of any product or circuit, and specifically disclaims any and all liability, including without limitation consequential or incidental damages. "Typical" parameters can and do vary in different applications and actual performance may vary over time. All operating parameters, including "Typical", must be validated for each customer application by customer's technical experts.

NXP does not convey any license under its patent rights nor the rights of others. NXP products are not designed, intended, or authorized for use as components in systems intended for surgical implant into the body, or other applications intended to support or sustain life, or for any other application in which the failure of the NXP product could create a situation where personal injury or death may occur.

Should the Buyer purchase or use NXP products for any such unintended or unauthorized application, the Buyer shall indemnify and hold NXP and its officers, employees, subsidiaries, affiliates, and distributors harmless against all claims, costs, damages, and expenses, and reasonable attorney fees arising out of, directly or indirectly, any claim of personal injury or death associated with such unintended or unauthorized use, even if such claim alleges NXP was negligent regarding the design or manufacture of the part. NXP and the NXP logo are trademarks of NXP B.V. All other product or service names are the property of their respective owners. © 2016 NXP B.V.

3 Getting started

3.1 Kit contents/packing list

The **TWR-17510EVB** contents includes:

- Assembled and tested evaluation board/module in anti-static bag
- Quick start guide

3.2 Jump start

NXP's analog product development boards provide an easy-to-use platform for evaluating NXP products. The boards support a range of analog, mixed-signal and power solutions. They incorporate monolithic ICs and system-in-package devices that use proven high-volume SMARTMOS technology. NXP products offer longer battery life, a smaller form factor, reduced component counts, lower cost and improved performance in powering state-of-the-art systems.

1. Go to www.nxp.com/TWR-17510EVB.
2. Review the tool summary page.
3. Locate and click:

Jump Start Your Design

4. Download the documents, software and other information.

Once the files are downloaded, review the user guide in the bundle. The user guide includes setup instructions, BOM and schematics. Jump start bundles are available on each tool summary page with the most relevant and current information. The information includes everything needed for design.

3.3 Required equipment and software

This kit requires the following items:

- DC Power supply (2.0 V to 15.0 V, 0.1 A to 1.2 A, depending on stepper motor requirements)
- Typical loads (brushed DC motors, high side MOSFET or power resistors)
- Wire cables for power supply and load connection
- Other Tower/Freedom modules (MCU, ELEV etc): <http://www.NXP.com/tower> or <http://www.NXP.com/freedom>

4 Understanding the Tower system

NXP's Tower System peripheral module is designed to be combined and used with other Tower System modules. The Tower System is a modular development platform for 8-, 16- and 32-bit MCUs and MPUs that enables advanced development through rapid prototyping. Featuring more than fifty development boards or modules, the Tower System provides designers with building blocks for entry-level to advanced MCU development.

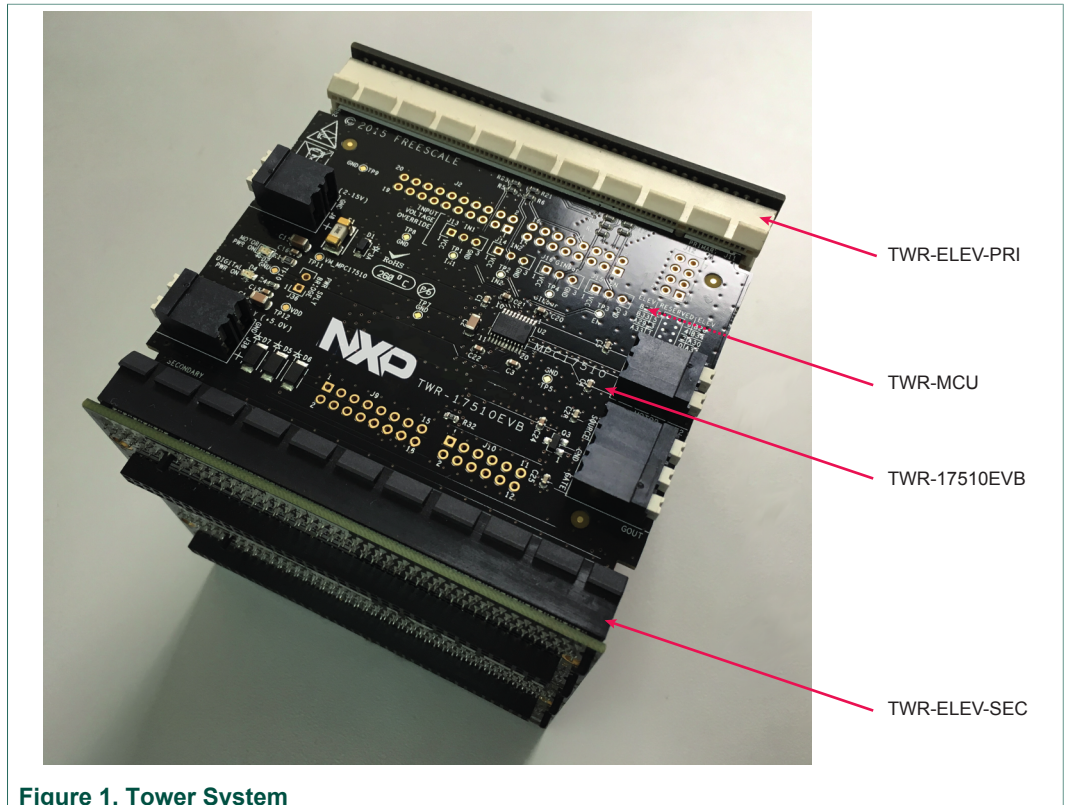

Figure 1. Tower System

4.1 Block diagram

[Figure 2](#) shows the hardware block diagram for the TWR-17510EVB:

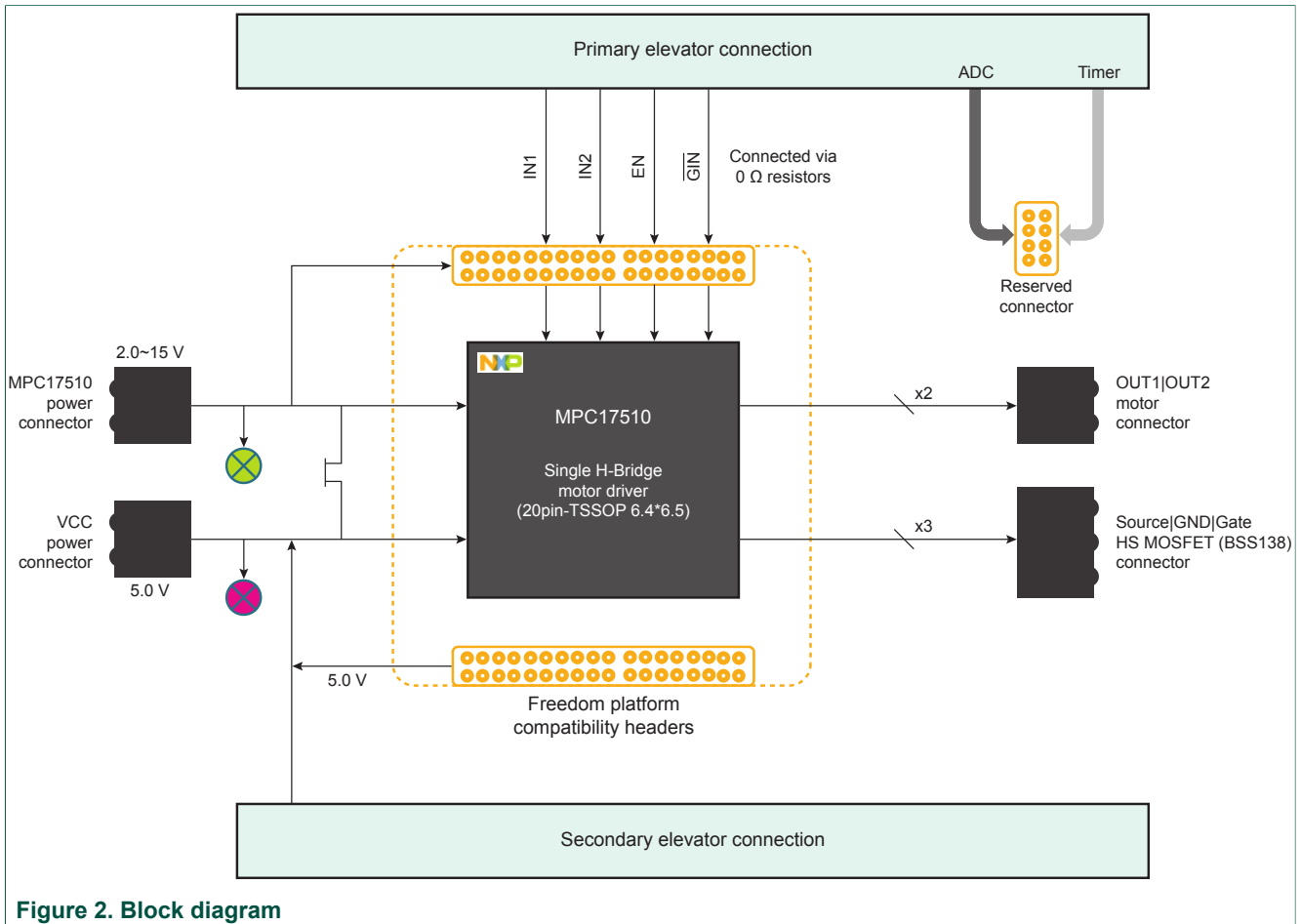

Figure 2. Block diagram

4.2 Device features

The board features the following NXP product:

Table 1. Device features

Device	Description	Features
MPC17510AEJ	The MPC17510AEJ is an H-Bridge motor driver IC intended for operating brushed DC motors.	<ul style="list-style-type: none"> Wide voltage range of operation from 2.0 V to 15 V Output current of 1.2 A (DC) continuous, 3.8 A peak 450 mΩ $R_{DS(on)}$ H-Bridge MOSFET outputs 5.0 V TTL/CMOS compatible inputs PWM frequencies up to 200 kHz Undervoltage shutdown Cross conduction (shoot through) suppression

5 Getting to know the hardware

5.1 Board overview

The TWR-17510EVB module is an easy-to-use development board that allows the user to exercise all the functions of the MPC17510AEJ H-bridge motor driver IC. The TWR-17510EVB can operate as a standalone tool and can also be combined and used as part of the modular Tower and Freedom System development platform.

5.2 Board features

The board features the following:

- Compatibility with NXP’s Tower and Freedom system development platform
- LEDs to indicate the supply status
- Transient voltage suppressor to handle system level transients
- Test points to allow probing of signals

5.3 Board description

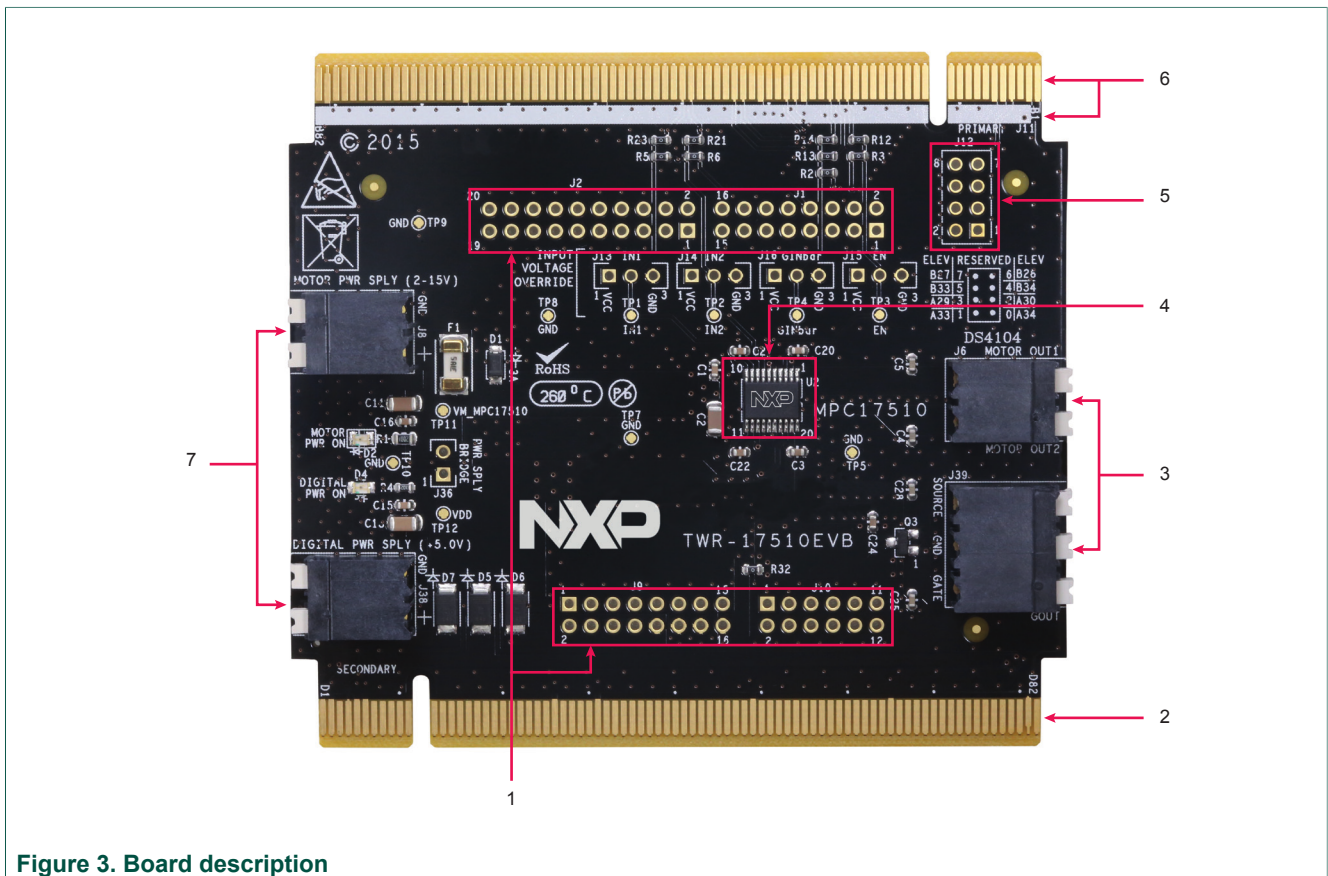

Figure 3. Board description

Table 2. Board description

Number	Name	Description
1	Arduino™ connectors	Supports connection to additional MCU Freedom boards
2	TWR-ELEV-SEC	Tower platform secondary elevator module
3	Motor and load connectors	Connectors for external motors and loads
4	MPC17510AEJ	H-Bridge motor driver IC
5	Reserved connector	Supports MCU ADC/PWM function expansion
6	TWR-ELEV-PRI	Tower platform primary elevator module (denoted by white stripe)
7	Power supply connectors	Connectors for motor and digital power supplies

5.4 LED display

The board contains the following LEDs:



Figure 4. LED locations

Table 3. LED locations

LED ID	Description
D2	GREEN LED—indicates when the motor power supply is connected to the MPC17510AEJ VM pin
D4	RED LED—indicates when the digital power supply is connected to the MPC17510AEJ VDD pin

5.5 Jumper definitions

Figure 5 shows the location of jumpers on the tower board.

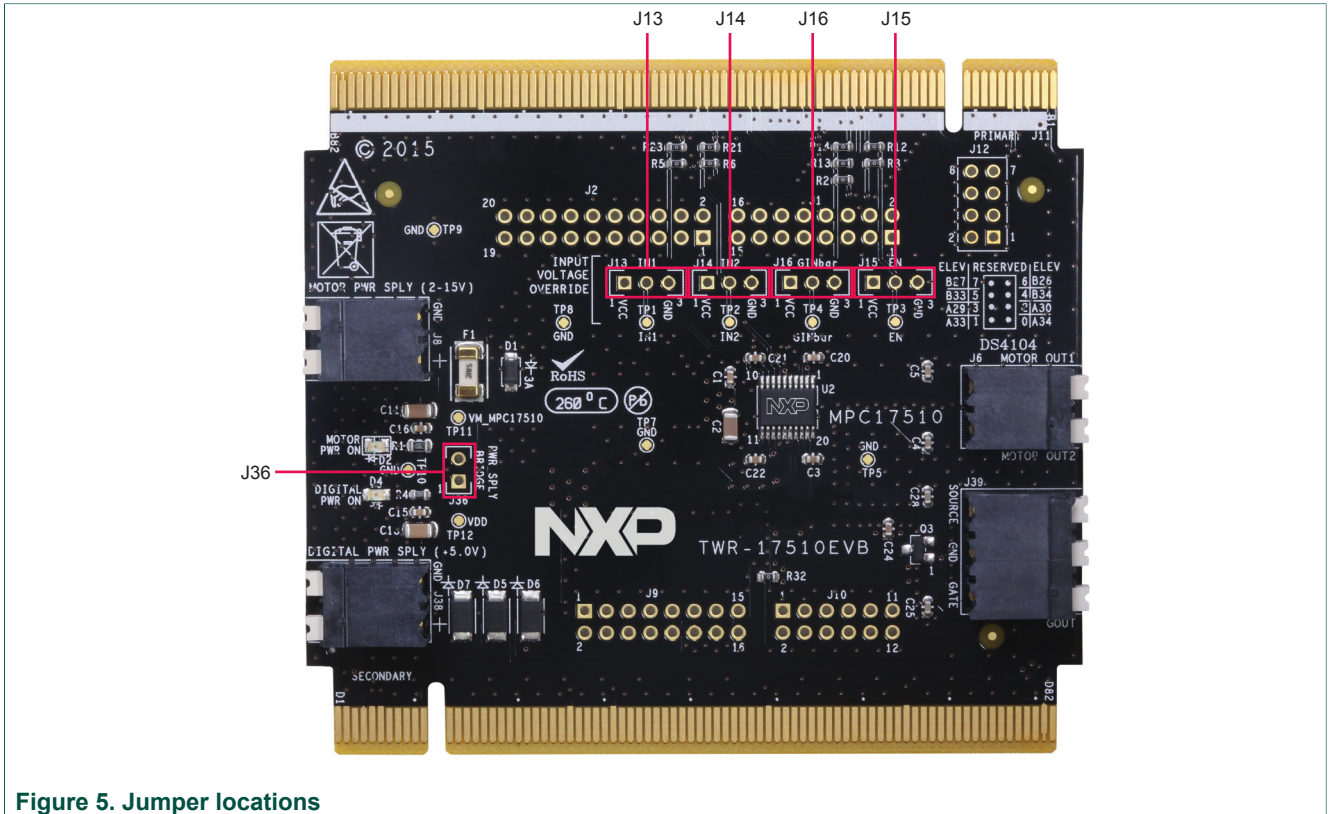

Figure 5. Jumper locations

Table 4 describes the function and settings for each jumper.

Table 4. Jumper definitions

Jumper/Switch	Description	Setting	Connection/Result
J13 ^[1]	IN1 short to VDD/ GND selection	1–2	IN1 connected to VDD 5.0 V
		2–3	IN1 connected to Ground
J14 ^[1]	IN2 short to VDD/ GND selection	1–2	IN2 connected to VDD 5.0 V
		2–3	IN2 connected to Ground
J15 ^[1]	EN short to VDD/ GND selection	1–2	EN connected to VDD 5.0 V
		2–3	EN connected to Ground
J16 ^[1]	GIN short to VDD/ GND selection	1–2	GIN connected to VDD 5.0 V
		2–3	GIN connected to Ground
J36 ^[1]	Power supply bridge	1–2	VM is connected to VDD
		Open	VM is disconnected from VDD

[1] DNP (Do not populate)

5.6 Test point definitions

The following test points provide access to various signals to and from the board.

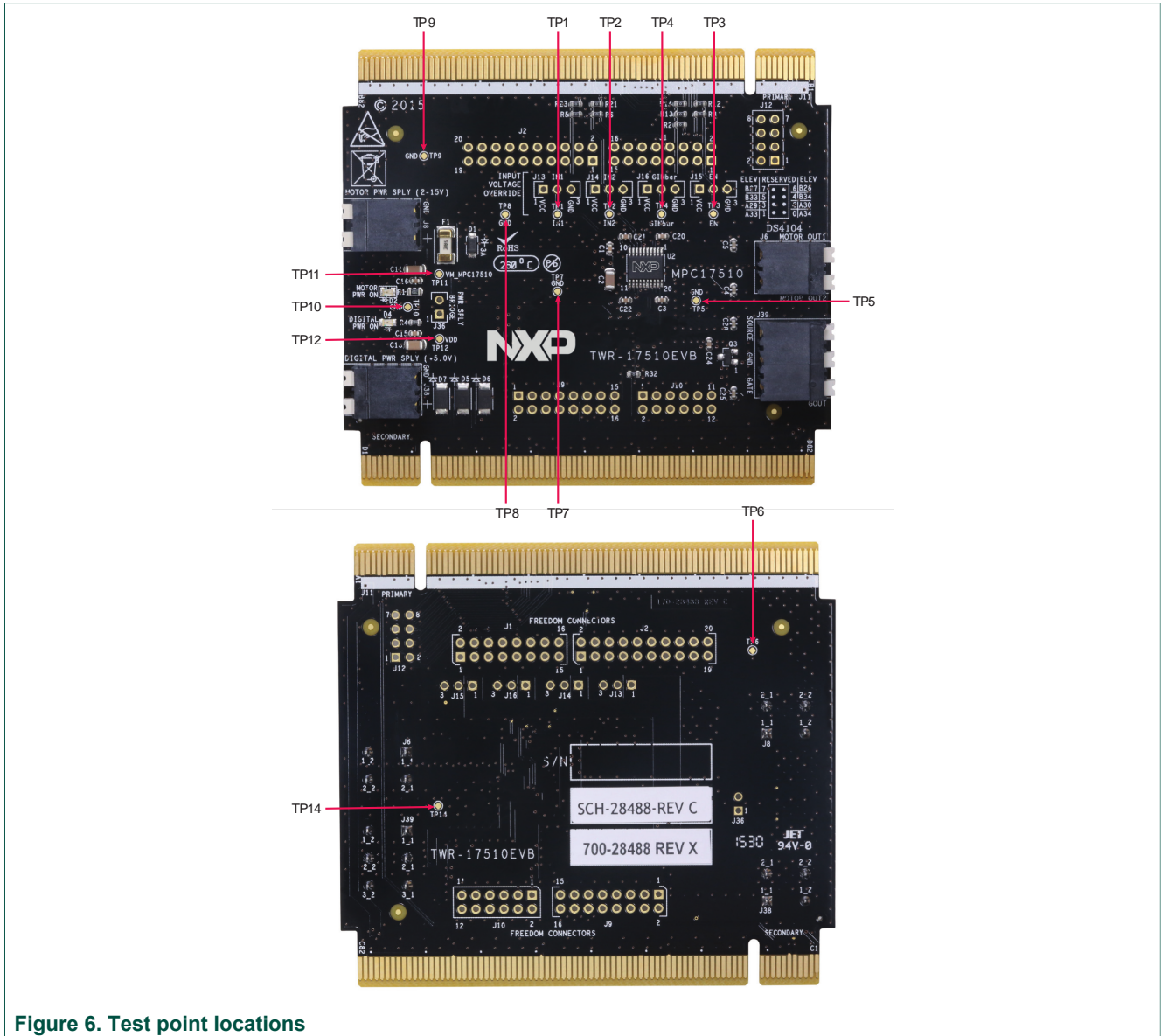

Figure 6. Test point locations

Table 5. Test point definitions

Test point name	Signal name	Description
TP1	IN1	In-circuit test IN1 probing / debug hook
TP2	IN2	In-circuit test IN2 probing / debug hook
TP3	EN	In-circuit test EN probing / debug hook
TP4	$\overline{\text{GIN}}$	In-circuit test $\overline{\text{GIN}}$ probing / debug hook
TP5	Ground	In-circuit test GND probing / debug ground hook
TP6	Ground	In-circuit test GND probing / debug ground hook

Test point name	Signal name	Description
TP7	Ground	In-circuit test GND probing / debug ground hook
TP8	Ground	In-circuit test GND probing / debug ground hook
TP9	Ground	In-circuit test GND probing / debug ground hook
TP10	Ground	In-circuit test GND probing / debug ground hook
TP11	VM	In-circuit test VM probing / debug hook
TP12	VDD	In-circuit test VDD probing / debug hook
TP14	Ground	In-circuit test GND probing / debug ground hook

5.7 Connectors

The board has the following connectors.

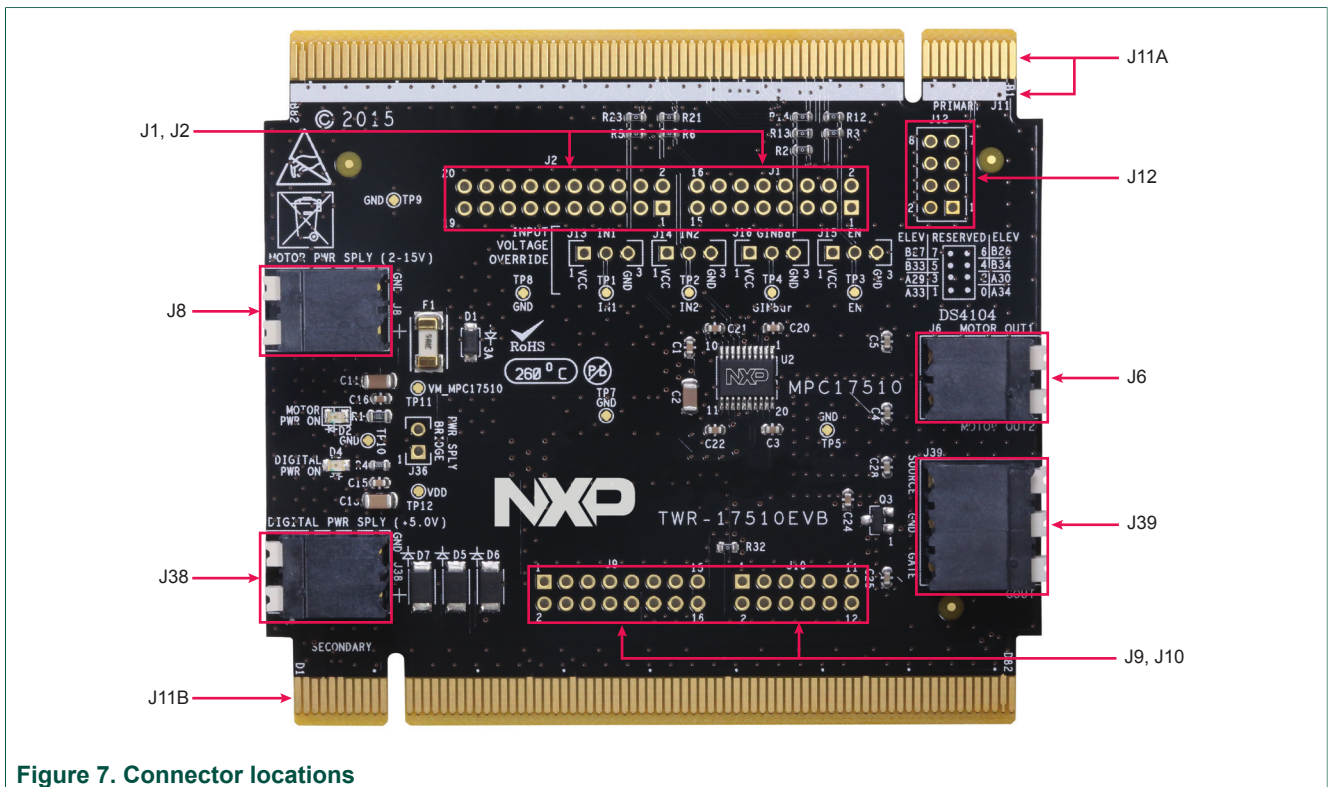

Figure 7. Connector locations

Table 6. Connectors

Connector name	Description
J1, J2	Arduino™ connectors for attaching additional Freedom boards
J6	Motor connector for H-bridge Channel 1 on the MPC17510AEJ
J8	Motor power supply connector for the MPC17510AEJ VM pin
J9, J10	Arduino™ connectors for attaching additional Freedom boards
J11A	Connects to the TWR-ELEV-PRI Tower elevator primary module. White stripe indicates that the male connector connects with the white female connectors on the Tower elevator primary module.

Connector name	Description
J11B	Connects to TWR-ELEV-SEC Tower elevator secondary module. The male connector connects with the female connectors on the Tower elevator secondary module.
J12	Reserved connector for MCU ADC/PWM interface
J38	Digital power supply connector for MC17510AEJ VDD
J39	External high-side MOS load connector

5.7.1 Tower elevator connections

TWR-17510EVB features two expansion card-edge connectors that interface to elevator boards in a Tower System: the Primary and Secondary Elevator connectors. [Table 7](#) provides the pinouts for the Primary Elevator Connector. There are no connections for the Secondary Elevator Connector.

Table 7. Primary elevator connector pinouts

Side B					Side A				
Pin #	Name	Group	Usage	Jmp ^[1]	Pin #	Name	Group	Usage	Jmp ^[1]
B1	5V	Power	5.0 V Power		A1	5V	Power	5.0 V Power	
B2	GND	Power	Ground		A2	GND	Power	Ground	
B3	3V3	Power	3.3 V Power		A3	3V3	Power	3.3 V Power	
B4	ELE_PS_SENSE	Power	Elevator Power Sense		A4	3V3	Power	3.3 V Power	
B5	GND	Power	Ground		A5	GND	Power	Ground	
B6	GND	Power	Ground		A6	GND	Power	Ground	
B7	SDHC_CLK / SPI1_CLK	SDHC / SPI 1			A7	SCL0	I ² C 0		
B8	SDHC_CS1_D3 / SPI1_CS1	SDHC / SPI 1			A8	SDA0	I ² C 0		
B9	SDHC_CS0_D3 / SPI1_CS0	SDHC / SPI 1			A9	GPIO9 /CTS1	GPIO / UART		
B10	SDHC_CMD / SPI1_MOSI	SDHC / SPI 1			A10	GPIO8 / SDHC_D2	GPIO / SDHC		
B11	SDHC_D0 / SPI1_MISO	SDHC / SPI 1			A11	GPIO7 / SD_WP_DET	GPIO / SDHC		
Mechanical Key									
B12	ETH_COL	Ethernet			A12	ETH_CRS	Ethernet		
B13	ETH_RXER	Ethernet			A13	ETH_MDC	Ethernet		
B14	ETH_TXCLK	Ethernet			A14	ETH_MDIO	Ethernet		
B15	ETH_TXEN	Ethernet			A15	ETH_RXCLK	Ethernet		
B16	ETH_TXER	Ethernet			A16	ETH_RXDV	Ethernet		
B17	ETH_TXD3	Ethernet			A17	ETH_RXD3	Ethernet		
B18	ETH_TXD2	Ethernet			A18	ETH_RXD2	Ethernet		

Side B					Side A				
Pin #	Name	Group	Usage	Jmp ^[1]	Pin #	Name	Group	Usage	Jmp ^[1]
B19	ETH_TXD1	Ethernet			A19	ETH_RXD1	Ethernet		
B20	ETH_TXD0	Ethernet			A20	ETH_RXD0	Ethernet		
B21	GPIO1 / RTS1	GPIO / UART	MPC17510_EN	X	A21	SSI_MCLK	SSI		
B22	GPIO2 / SDHC_D1	GPIO / SDHC	MPC17510_GIN	X	A22	SSI_BCLK	SSI		
B23	GPIO3	GPIO	MPC17510_GIN	X	A23	SSI_FS	SSI		
B24	CLKIN0	Clock			A24	SSI_RXD	SSI		
B25	CLKOUT1	Clock			A25	SSI_TXD	SSI		
B26	GND	Power	Ground		A26	GND	Power	Ground	
B27	AN7	ADC	Reserved 7		A27	AN3	ADC		
B28	AN6	ADC	Reserved 6		A28	AN2	ADC		
B29	AN5	ADC			A29	AN1	ADC	Reserved 3	
B30	AN4	ADC			A30	AN0	ADC	Reserved 2	
B31	GND	Power	Ground		A31	GND	Power	Ground	
B32	DAC1	DAC			A32	DAC0	DAC		
B33	TMR3	Timer	Reserved 5		A33	TMR1	Timer	Reserved 1	
B34	TMR2	Timer	Reserved 4		A34	TMR0	Timer	Reserved 0	
B35	GPIO4	GPIO			A35	GPIO6	GPIO		
B36	3V3	Power	3.3 V Power		A36	3V3	Power	3.3 V Power	
B37	PWM7	PWM			A37	PWM3	PWM		
B38	PWM6	PWM			A38	PWM2	PWM		
B39	PWM5	PWM	MPC17510_IN2	X	A39	PWM1	PWM		
B40	PWM4	PWM	MPC17510_IN1	X	A40	PWM0	PWM		
B41	CANRX	CAN			A41	RXD0	UART 0		
B42	CANTX	CAN			A42	TXD0	UART 0		
B43	1WIRE	1-Wire			A43	RXD1	UART 1		
B44	SPI0_MISO	SPI 0			A44	TXD1	UART 1		
B45	SPI0_MOSI	SPI 0			A45	GPIO10	GPIO	VSSA	
B46	SPI0_CS0	SPI 0			A46	GPIO11	GPIO	VDDA	
B47	SPI0_CS1	SPI 0			A47	GPIO12	GPIO		
B48	SPI0_CLK	SPI 0			A48	GPIO13	GPIO		
B49	GND	Power	Ground		A49	GND	Power	Ground	
B50	SCL1	I2C 1			A50	GPIO14	GPIO		

Side B					Side A				
Pin #	Name	Group	Usage	Jmp ^[1]	Pin #	Name	Group	Usage	Jmp ^[1]
B51	SDA1	I2C 1			A51	GPIO15	GPIO		
B52	GPIO5 / SD_CARD_DET	GPIO/SDHC			A52	GPIO16	GPIO		
B53	USB0_DP_PDOWN	USB 0			A53	GPIO17	GPIO		
B54	USB0_DM_PDOWN	USB 0			A54	USB0_DM	USB 0		
B55	IRQ_H	Interrupt			A55	USB0_DP	USB 0		
B56	IRQ_G	Interrupt			A56	USB0_ID	USB 0		
B57	IRQ_F	Interrupt			A57	USB0_VBUS	USB 0		
B58	IRQ_E	Interrupt			A58	TMR7	Timer		
B59	IRQ_D	Interrupt			A59	TMR6	Timer		
B60	IRQ_C	Interrupt			A60	TMR5	Timer		
B61	IRQ_B	Interrupt			A61	TMR4	Timer		
B62	IRQ_A	Interrupt			A62	RSTIN_b	Reset		
B63	EBI_ALE/EBI_CS1_b	EBI			A63	RSTOUT_b	Reset		
B64	EBI_CS0_b	EBI			A64	CLKOUT0	Clock		
B65	GND	Power	Ground		A65	GND	Power	Ground	
B66	EBI_AD15	EBI			A66	EBI_AD14	EBI		
B67	EBI_AD16	EBI			A67	EBI_AD13	EBI		
B68	EBI_AD17	EBI			A68	EBI_AD12	EBI		
B69	EBI_AD18	EBI			A69	EBI_AD11	EBI		
B70	EBI_AD19	EBI			A70	EBI_AD10	EBI		
B71	EBI_R/W_b	EBI			A71	EBI_AD9	EBI		
B72	EBI_OE_b	EBI			A72	EBI_AD8	EBI		
B73	EBI_D7	EBI			A73	EBI_AD7	EBI		
B74	EBI_D6	EBI			A74	EBI_AD6	EBI		
B75	EBI_D5	EBI			A75	EBI_AD5	EBI		
B76	EBI_D4	EBI			A76	EBI_AD4	EBI		
B77	EBI_D3	EBI			A77	EBI_AD3	EBI		
B78	EBI_D2	EBI			A78	EBI_AD2	EBI		
B79	FB_D1	Flexbus			A79	FB_AD1	Flexbus		
B80	FB_D0	Flexbus			A80	FB_AD0	Flexbus		
B81	GND	Power	Ground		A81	GND	Power	Ground	
B82	3V3	Power	3.3 V Power		A82	3V3	Power	3.3 V Power	

[1] An 'X' in this column indicates a zero ohm resistor is connected between the pin and the connector.

5.7.2 Freedom platform connections

The TWR-17510EVB features four connectors that interface with other Freedom boards. [Table 8](#) provides the pinouts for the connectors.

Table 8. Freedom connector pinouts

I/O Header & Pin Num	Arduino™ R3 Pin Name	FRDM Pin Name	Used	Jmp ^[1]
J9 08	5V	P5VVDD	X	X
J9 10	5V			
J10 02	A0			
J10 04	A1			
J10 06	A2			
J10 08	A3			
J10 10	A4			
J10 12	A5			
J2 16	AREF			
J1 02	D0			
J1 04	D1			
J2 06	D10			
J2 08	D11			
J2 10	D12			
J2 12	D13			
J2 20	D14			
J2 18	D15			
J1 06	D2	MPC17510_IN1	X	X
J1 08	D3	MPC17510_IN2	X	X
J1 10	D4	MPC17510_EN	X	X
J1 12	D5	MPC17510_GIN	X	X
J1 14	D6			
J1 16	D7			
J2 02	D8			
J2 04	D9			
J9 12	GND	GND	X	X
J9 14	GND	GND	X	X
J2 14	GND			
J9 04	IOREF			
J9 02	RFU			
J9 16	VIN			

[1] An 'X' in this column indicates a zero ohm resistor is connected between the pin and the connector.

6 Schematics, board layout and bill of materials

TWR-17510EVB board schematics, board layout and bill of materials are available in the download tab of the TWR-17510EVB Tool summary page at the following URL:
www.nxp.com/TWR-17510EVB

7 References

The following are URLs related to NXP products and application solutions:

NXP.com support pages	Description	URL
TWR-17510EVB	Tool summary page	www.nxp.com/TWR-17510EVB
MPC17510	Product summary page	www.nxp.com/MPC17510

8 Contact information

Visit <http://www.nxp.com/support> for a list of phone numbers within your region.

Visit <http://www.nxp.com/warranty> to submit a request for tool warranty.

9 Revision history

Revision	Date	Description of changes
1.0	8/2016	Initial release

10 Legal information

10.1 Definitions

Draft — The document is a draft version only. The content is still under internal review and subject to formal approval, which may result in modifications or additions. NXP Semiconductors does not give any representations or warranties as to the accuracy or completeness of information included herein and shall have no liability for the consequences of use of such information.

10.2 Disclaimers

Information in this document is provided solely to enable system and software implementers to use NXP products. There are no express or implied copyright licenses granted hereunder to design or fabricate any integrated circuits based on the information in this document. NXP reserves the right to make changes without further notice to any products herein.

NXP makes no warranty, representation, or guarantee regarding the suitability of its products for any particular purpose, nor does NXP assume any liability arising out of the application or use of any product or circuit,

and specifically disclaims any and all liability, including without limitation consequential or incidental damages. "Typical" parameters that may be provided in NXP data sheets and/or specifications can and do vary in different applications, and actual performance may vary over time. All operating parameters, including "typicals," must be validated for each customer application by customer's technical experts. NXP does not convey any license under its patent rights nor the rights of others. NXP sells products pursuant to standard terms and conditions of sale, which can be found at the following address: nxp.com/salestermsandconditions.

10.3 Trademarks

Notice: All referenced brands, product names, service names and trademarks are the property of their respective owners.

NXP — is a trademark of NXP B.V.

the NXP logo — is a trademark of NXP B.V.

Freescale — is a trademark of NXP B.V.

the Freescale logo — is a trademark of NXP B.V.

SMARTMOS — is a trademark of NXP B.V.

Tables

Tab. 1.	Device features	5	Tab. 5.	Test point definitions	9
Tab. 2.	Board description	7	Tab. 6.	Connectors	10
Tab. 3.	LED locations	7	Tab. 7.	Primary elevator connector pinouts	11
Tab. 4.	Jumper definitions	8	Tab. 8.	Freedom connector pinouts	14

Figures

Fig. 1.	Tower System	4	Fig. 5.	Jumper locations	8
Fig. 2.	Block diagram	5	Fig. 6.	Test point locations	9
Fig. 3.	Board description	6	Fig. 7.	Connector locations	10
Fig. 4.	LED locations	7			

Contents

1	TWR-17510EVB	1
2	Important notice	2
3	Getting started	3
3.1	Kit contents/packing list	3
3.2	Jump start	3
3.3	Required equipment and software	3
4	Understanding the Tower system	4
4.1	Block diagram	4
4.2	Device features	5
5	Getting to know the hardware	6
5.1	Board overview	6
5.2	Board features	6
5.3	Board description	6
5.4	LED display	7
5.5	Jumper definitions	8
5.6	Test point definitions	9
5.7	Connectors	10
5.7.1	Tower elevator connections	11
5.7.2	Freedom platform connections	14
6	Schematics, board layout and bill of materials	15
7	References	15
8	Contact information	15
9	Revision history	15
10	Legal information	16

© NXP B.V. 2016. All rights reserved

For more information, please visit: <http://www.nxp.com>

For sales office addresses, please send an email to: salesaddresses@nxp.com

Released on 2 August 2016

Компания «Life Electronics» занимается поставками электронных компонентов импортного и отечественного производства от производителей и со складов крупных дистрибьюторов Европы, Америки и Азии.

С конца 2013 года компания активно расширяет линейку поставок компонентов по направлению коаксиальный кабель, кварцевые генераторы и конденсаторы (керамические, пленочные, электролитические), за счёт заключения дистрибьюторских договоров

Мы предлагаем:

- Конкуренспособные цены и скидки постоянным клиентам.
- Специальные условия для постоянных клиентов.
- Подбор аналогов.
- Поставку компонентов в любых объемах, удовлетворяющих вашим потребностям.
- Приемлемые сроки поставки, возможна ускоренная поставка.
- Доставку товара в любую точку России и стран СНГ.
- Комплексную поставку.
- Работу по проектам и поставку образцов.
- Формирование склада под заказчика.
- Сертификаты соответствия на поставляемую продукцию (по желанию клиента).
- Тестирование поставляемой продукции.
- Поставку компонентов, требующих военную и космическую приемку.
- Входной контроль качества.
- Наличие сертификата ISO.

В составе нашей компании организован Конструкторский отдел, призванный помогать разработчикам, и инженерам.

Конструкторский отдел помогает осуществить:

- Регистрацию проекта у производителя компонентов.
- Техническую поддержку проекта.
- Защиту от снятия компонента с производства.
- Оценку стоимости проекта по компонентам.
- Изготовление тестовой платы монтаж и пусконаладочные работы.



Тел: +7 (812) 336 43 04 (многоканальный)

Email: org@lifeelectronics.ru