

## FZ-Lite VISION SENSOR

Easy inspection beyond expectation



» Intuitive user guidance

» Crystal-clear imaging

» Flexible Vision platform

# Simple, flexible & crystal clear

*The new FZ-Lite integrates the benefits of a Smart Camera and a powerful Vision System in a single platform.*

*The unique image clarity achieved by using an intelligent camera enables simple setup, fast installation and enhanced optical performance.*

*In combination with the powerful FZ-Lite controller it takes you into a new dimension of image processing. Highest performance, simplicity and unique flexibility are defining a new standard for Compact Vision Sensors.*

## Features

- Crystal-clear image quality
- Real Color Processing (16 million colors)
- C-mount and Smart Cameras
- EtherNet/IP & TCP/IP communication

## Benefits

- Simple and guided set-up
- Reliable results on any surface
- One platform for any application



Intelligent Compact Camera

Lite Controller



Monitor

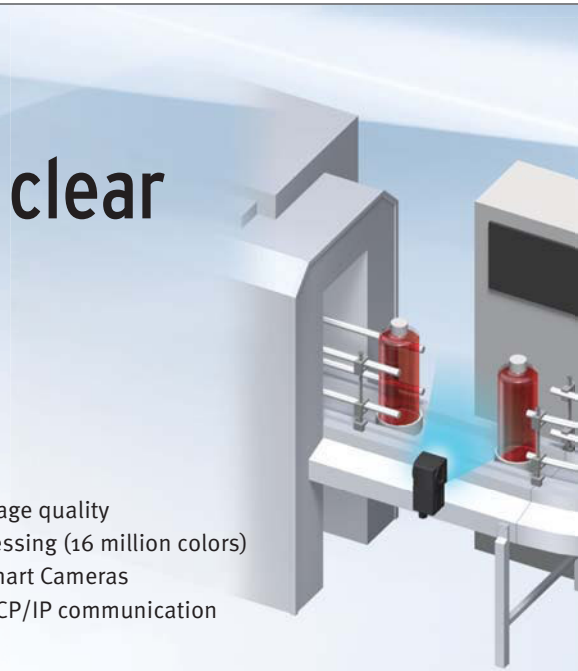

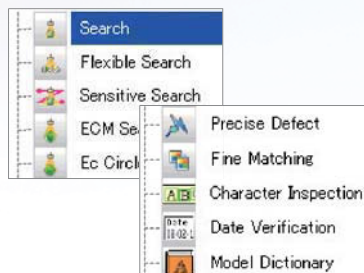
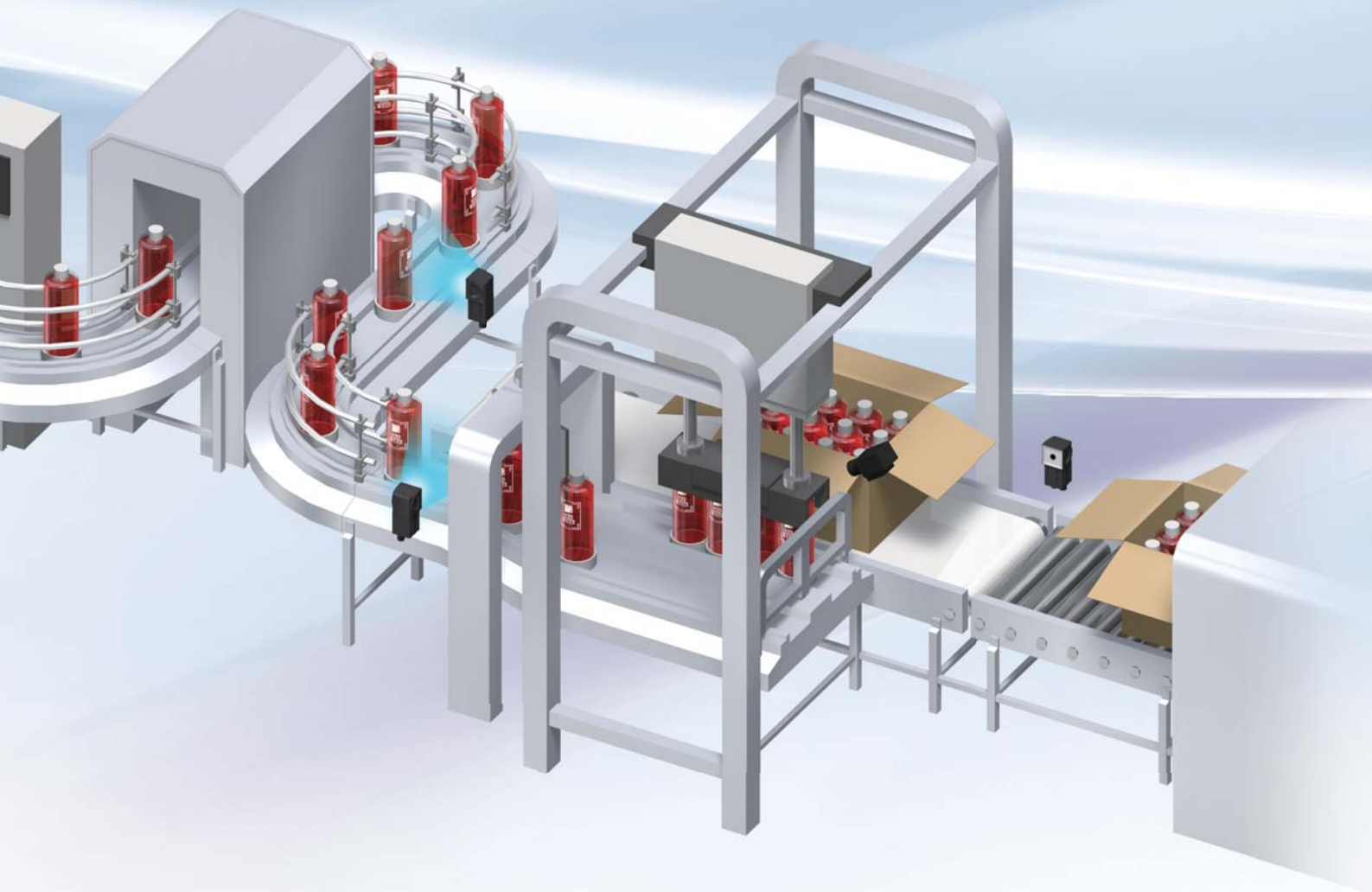

### > Simple Operation

FZ-Lite supports the Smart Camera technology from the FQ-series Sensors. This allows fast and easy installation of the camera on the machine, without further optics and illumination. Crystal Clear images can be easily captured using High-power Lighting and a Polarizing Filter that eliminates glare.

### >> Flexible Flow configuration

More than 20 processing items are provided by FZ-Lite, such as dimension measurements, various search items (pattern, contour), defects, edge and count tools. These processing items, can be combined in a flow program, offering branches or loops. This offers a new dimension of flexibility for Compact Vision Sensors.

### >>> Open Network

EtherNet/IP, a global standard for factory automation data networking, is supported for seamless integration into a production line or machine. This allows users to easily connect to any EtherNet/IP enabled devices from any manufacturer. Further communication is possible via TCP/IP, serial and parallel interfaces.



# A new benchmark in image clarity

> Simple Operation

Achieving sharp and crystal clear images that improve inspection performance has never been so easy. The FZ-Lite features powerful functions, to eliminate the effects of direct reflections, environmental light interference and big variations in brightness. These cutting edge functions shorten and simplify the installation and setup procedure. Simply don't care anymore about how to install the camera in the best way, to get a sharp image.

## Camera with integrated High-power Lighting

The Camera utilizes integrated High-power Lighting that enables uniform illumination in the field of view. Utilizing a new optical design, bright and clear images can be achieved without additional lighting. A Polarizing Filter can be used to cut direct light reflections to eliminate the common issue of glare resulting from highly reflective surfaces.

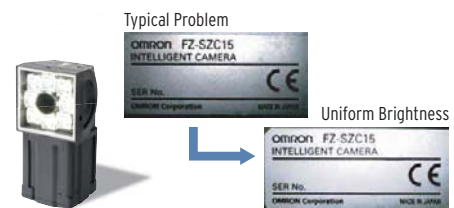

## HDR Sensing

A high dynamic range (HDR) function is provided to eliminate the influence of objects with irregular reflectance and changes in external light conditions. By increasing the high dynamic range by a factor of up to 5,000, objects that previously could not be detected due to inconsistent lighting or halation can be clearly inspected.

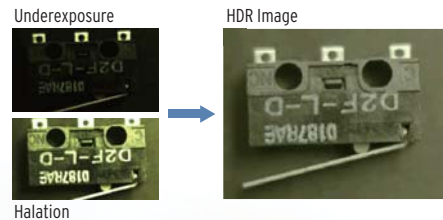

## Real Color Sensing

Color sensing is standard for OMRON Vision Sensors. Real color processing enables stable detection of minute color differences, which is difficult to perform using color gray processing or filtering. It is not necessary to perform color extraction or redo the setup every time the workpiece color changes.

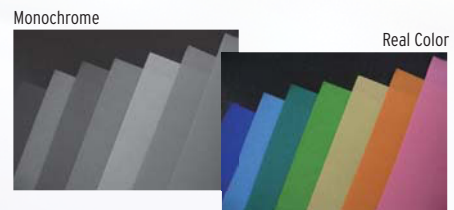

## 2 Million Pixel Camera

Inspections that require high resolution can be solved with the 2 Million Pixel Camera. Presence and dimension inspections can be realized. At a rate of 30 frames per second. The input speed is the highest in this class. The use of a C-mount Lens enables applications in any field of view.

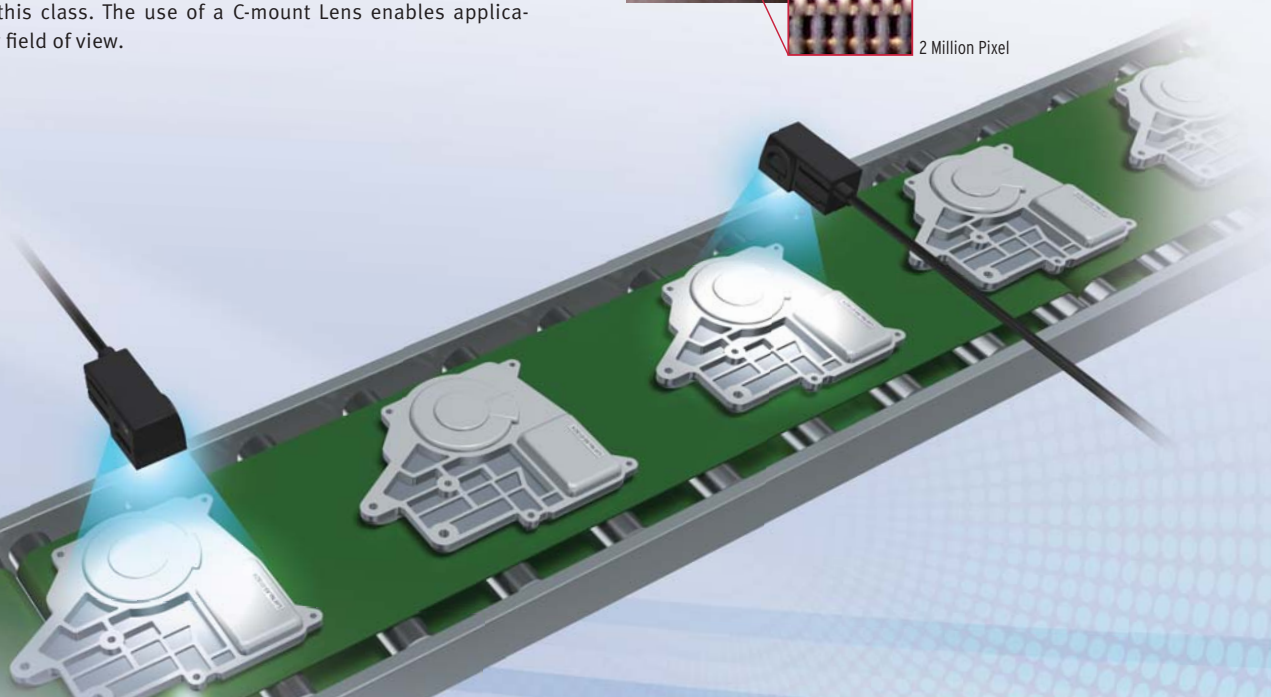
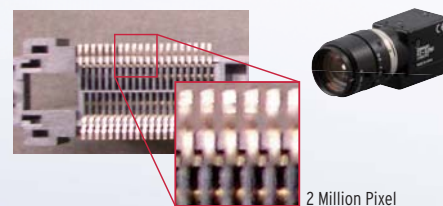

# Powerful processing items for any inspection and industry

>> Flexible Application

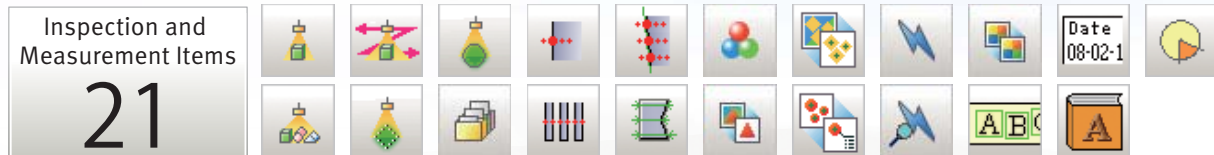

## Measurements

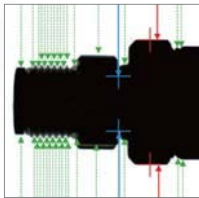

### Dimension Measurements

#### Scan Edge Width

Multiple measurements can be performed on the objects for their minimum width, maximum width, and average width. Enhanced performance is also provided to detect the depth of grooves on metal shafts.

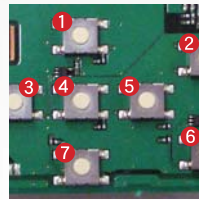

### Workpiece Count

#### Labeling

A cluster of objects is extracted as labels, and the parameters for area, center of gravity, and other factors are generated for output and further processing. Perform measurements for roundness, enclosing rectangles, and circumference measurement. Counting by sorting of the labels according to coordinates or size can also be performed.

## Appearance Inspections

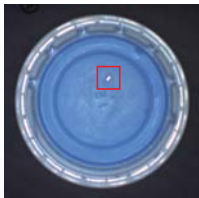

### Inspection of Defects

#### Defects

Perform inspection of defects and dirt on solid-colored objects, component chips or burrs.

#### Fine Matching

Fine Matching is ideal when the background has a pattern. In Combination with the standard image it enables high-speed, high-precision inspection for minute dirt and edge chips.

A: Standard work	
QTY:60	Materials Amount
	Vitamin A 10g
	Vitamin D 10g
	Vitamin E 10g
TAKE ONE TABLET BY MOUTH TWICE DAILY	
<b>Amount per Tablet</b>	
CALCIUM	100%
IRON	80%

### Detection of Subtle Differences

#### Sensitive Search

Detailed matching is performed by automatically separating a registered image. Subtle differences that cannot be determined using normal searches are detected with good stability and correlation difference. So, there's no need for accurate threshold settings.

B: Different kind work	
QTY:60	Materials Amount
	Vitamin A 10g
	Vitamin D 10g
	Vitamin E 10g
TAKE ONE TABLET BY MOUTH TWICE DAILY	
<b>Amount per Tablet</b>	
CALCIUM	100%
IRON	80%

## Character Inspections



### Inspection of Expiration Dates

#### Date Verification

By simply setting the period of production, the character string can be automatically verified and the printing can be easily validated. The printed expiration date is changed automatically every day.

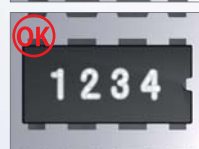

### Prevention of False Rejections

#### Flexible Search

Inspection can be performed to accept items with variations in printing quality and shape, and to reject only those items that are obviously wrong. Registering multiple images of acceptable items as models enables stable searching regardless of the printing quality or changes in shape.

## Choose the interface you need

>>> Open Network

A variety of interfaces, such as EtherNet/IP, general-purpose Ethernet, and serial communications allows easy communication with a PLC or other external devices.

### EtherNet/IP

#### Easier, Faster

EtherNet/IP is a widely used communication protocol in factories around the world. You can easily connect to OMRON PLCs or any other vendor device that supports EtherNet/IP to enable high-speed communication.

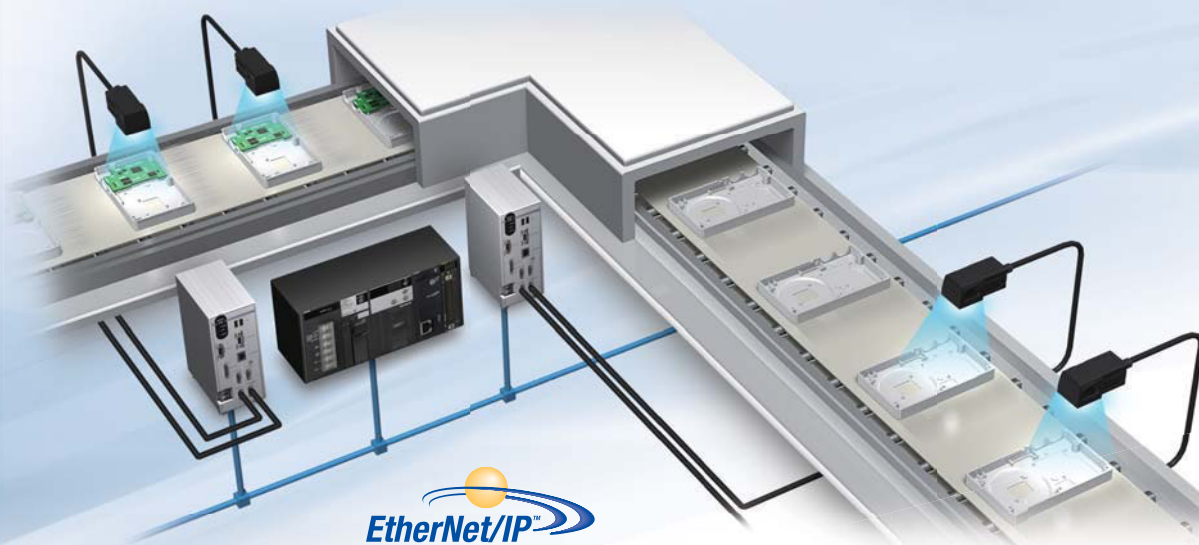

### PLC Link Function

#### Easy Creation of Ladder Programs

A PLC Link function is included to reduce the effort in ladder programming for serial communications and standard Ethernet.

#### Applicable PLCs

- OMRON CS, CJ, CP, and NSJ Series
- Mitsubishi Electric Q Series

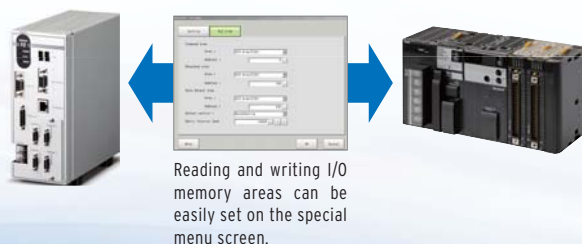

### Network Drive Function

#### Network Logging

The network drive function in FZ-Lite allows users to output and store images and measurement values to computers over a network, not limited to internal or only to USB memory. Connecting a large-capacity hard drive enables long-term image logging. It can also be used for storage of configuration data. Back-up and restore of any data over the network is also supported.

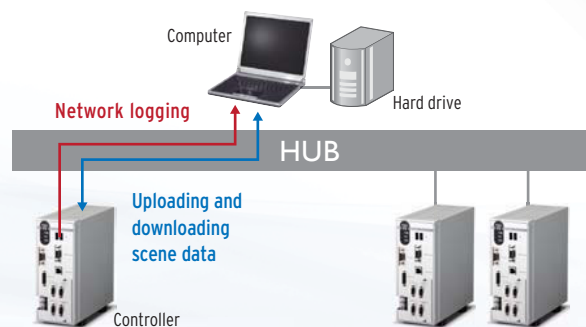









## Controllers

Appearance	Type		Model	Remarks
	Lite Controllers	Two-camera controllers	NPN <b>FZ3-L350</b>	—
			PNP <b>FZ3-L355</b>	—
	Four-camera controllers	NPN <b>FZ3-L350-10</b>	—	
		PNP <b>FZ3-L355-10</b>	—	

## Cameras









Appearance	Type		Model	Remarks
	Intelligent Compact Cameras	Wide View (Short-distance) □100mm	Color <b>FZ-SQ100N</b>	Camera + Lens + High-power Lighting
		Wide View (Long-distance) □100mm	Color <b>FZ-SQ100F</b>	
		Standard □50mm	Color <b>FZ-SQ050F</b>	
		Narrow View □10mm	Color <b>FZ-SQ010F</b>	
	Intelligent Cameras	Wide field of vision	Color <b>FZ-SLC100</b>	Camera + Zoom, Autofocus Lens + Intelligent Lighting
		Narrow field of vision	Color <b>FZ-SLC15</b>	
	Autofocus Cameras	Wide field of vision	Color <b>FZ-SZC100</b>	Camera + Zoom, Autofocus Lens
		Narrow field of vision	Color <b>FZ-SZC15</b>	
	Digital Cameras	2 million pixels	Color <b>FZ-SC2M</b>	Lens required
			Monochrome <b>FZ-S2M</b>	
	Digital Cameras	300,000-pixels	Color <b>FZ-SC</b>	
			Monochrome <b>FZ-S</b>	
	Small Digital Cameras	300,000-pixel flat type	Color <b>FZ-SFC</b>	
			Monochrome <b>FZ-SF</b>	
	Small Digital Cameras	300,000-pixel pen type	Color <b>FZ-SPC</b>	
			Monochrome <b>FZ-SP</b>	
	High-speed Cameras	300,000-pixels	Color <b>FZ-SHC</b>	
			Monochrome <b>FZ-SH</b>	

## Cameras peripheral devices

Appearance	Type	Model	Remarks
	CCTV Lenses	<b>3Z4S-LE Series</b>	—
	Extension Tubes		—
	Low-distortion Lenses	<b>FZ-LEH5/LEH8/LEH12/LEH16/LEH25/LEH35/LEH50/LEH75/LEH100</b>	Low distortion lens for 2-million Pixel Cameras
	Lenses for Small Camera	<b>FZ-LES3/LES6/LES16/LES30</b>	Lens for 300,000-pixel Small Cameras
	Extension Tubes for Small Camera	<b>FZ-LESR</b>	Extension Tubes for 300,000-pixel Small Cameras
	Intelligent Camera Diffusion Plate	Wide field of vision <b>FZ-SLC100-DL</b>	—
		Narrow field of vision <b>FZ-SLC15-DL</b>	—

## Ordering Information

### Cables

Appearance	Type	Cable length:	Model	Remarks
	Camera Cable	2m, 5m, 10m (See note 2)	<b>FZ-VS</b>	—
	Bend resistant Camera Cables	2m, 5m, 10m (See note 3)	<b>FZ-VSB</b>	—
	Right-angle Camera Cable (See note 1)	2m, 5m, 10m (See note 2)	<b>FZ-VSL</b>	—
	Long-distance Camera Cable	15m (See note 4)	<b>FZ-VS2</b>	—
	Long-distance Right-angle Camera Cable	15m (See note 4)	<b>FZ-VSL2</b>	—
	Cable Extension Unit	Maximum cable length: 45 m (Up to two Extension Units and three Cables can be connected.)	<b>FZ-VSJ</b>	—
	Monitor Cable	2m, 5m	<b>FZ-VM</b>	—
	Parallel Cable	2m, 5m	<b>FZ-VP</b>	—
		2m, 5m, Connector-type	<b>FZ-VPX</b> (See note 5)	—

**Note: 1.** This Cable has an L-shaped connector on the Camera end.





**2.** The 10-m Cable cannot be used for the Intelligent Camera and Autofocus Camera.

**3.** The 10-m Cable cannot be used for the Intelligent Camera, Autofocus Camera and 2 Million-pixel Camera.

**4.** The 15-m Cable cannot be used for the Intelligent Camera and Autofocus Camera.

**5.** Connector-Terminal Block Conversion Units can be connected (Recommended Products: OMRON XW2B-50G4/50G5, XE2D-50G6).

### Peripheral devices

Appearance	Type		Model	Remarks
	LCD Monitor		<b>FZ-M08</b>	—
	USB Memory		<b>FZ-MEM1G</b>	Capacity: 1 GB
	Strobe Controller	For 3Z4S-LT Series	One channel	Manufactured by MORITEX Corporation <b>3Z4S-LT MLEK-C100E1TS2</b> Required to control external lighting from a Controller
		For FZ-LT Series	One channel	
	Strobe Controller		For FZ-LT Series	Two channels
		—		Mouse
—	External Lighting	3Z4S-LT Series		—
		FZ-LT Series		—



## Lite Controller

Model	NPN		FZ3-L350	FZ3-L350-10
	PNP		FZ3-L355	FZ3-L355-10
No. of Cameras			2	4
Processing resolution	With Intelligent Compact Camera		752 (H) × 480 (V)	
	When connected to a 300,000-pixel camera		640 (H) × 480 (V)	
	When connected to a 2 million-pixel camera		1600 (H) × 1200 (V)	
Main functions	Processing Items	Inspections / Measurement	Search, Flexible Search, Sensitive Search, ECM Search, Ec Circle Search, Classification, Edge Position, Edge Pitch, Scan Edge Position, Scan Edge Width, Color Data, Gravity and Area, Labeling, Label Data, Defect, Precise Defect, Fine Matching, Character Inspection, Date Verification, Model Dictionary, Circle Angle	
		Image Capturing	Camera image Input, Camera Image Input HDR, Camera Image Input HDR Lite, Camera Switching, Measurement Image Switching	
		Correcting images	Position Compensation, Filtering, Background Suppression, Color Gray Filter, Extract Color Filter, Anti Color Shading, Polar Transformation	
		Assisting inspections / measurement	Calculation, Line Regression, Circle Regression, Set Unit Data, Get Unit Data, Set Unit Figure, Get Unit Figure, Trend Monitor, Image Logging, Data Logging, Elapsed Time, Wait, Focus, Iris	
		Branching processing	Conditional Branch, End, DI Branch	
		Outputting results	Serial data output, Parallel data output, Parallel judgement output, Fieldbus data output	
		Displaying results on the monitor	Result Display, Display Image File, Display Last NG Image	
	Number of simultaneous inspections <sup>1</sup>		No limit to setting (as permitted by memory capacity)	
	Position compensation		Yes (flexible combination with processing items for inspections and measurements)	
	Number of registered scenes		32	
Number of logged images (See note 1.)	With Intelligent Compact Camera	Connected to 1 camera	214	
		Connected to 2 cameras	107	
		Connected to 3 cameras	71	
		Connected to 4 cameras	53	
	When connected to a 300,000-pixel camera	Connected to 1 camera	Color Camera: 250, Monochrome Camera: 252	
		Connected to 2 cameras	Color Camera: 125, Monochrome Camera: 126	
		Connected to 3 cameras	Color Camera: 83, Monochrome Camera: 84	
		Connected to 4 cameras	Color Camera: 62, Monochrome Camera: 63	
	When connected to a 2 million-pixel camera	Connected to 1 camera	Color Camera: 40, Monochrome Camera: 40	
		Connected to 2 cameras	Color Camera: 20, Monochrome Camera: 20	
		Connected to 3 cameras	Color Camera: 13, Monochrome Camera: 13	
		Connected to 4 cameras	Color Camera: 10, Monochrome Camera: 10	
I/O specifications	Serial communications		RS-232C 1CH	
	Network communications		Ethernet 1000BASE-T/100BASE-TX/10BASE-T	
	EtherNet/IP		Ethernet port baud rate: 100 Mbps (100Base-TX)	
	Parallel I/O		11 inputs (RESET, STEP, DSA, and DI 0 to 7), 26 outputs (RUN, BUSY, GATE, OR, READY, ERROR, STGOUT 0 to 3, and DO 0 to 15)	
Monitor interface			Analog RGB video output, 1 channel (Resolution: XGA 1,024 × 768 dots)	
USB interface			2 channels (supports USB 1.1 and 2.0)	
Operation			Mouse or similar device	
Settings			Create series of processing steps by editing the flowchart (Help messages provided).	
Ratings	Power supply voltage (See note 2.)		20.4 to 26.4 VDC	
	Current consumption (See note 3.) (at 24.0 VDC)	With Intelligent Compact Camera	4.0 A max.	5.5 A max.
		When connected to a intelligent or autofocus camera		
		When connected to a 300,000-pixel camera	2.6 A max.	2.9 A max.
When connected to a 2 million-pixel camera				
Environmental immunity	Ambient temperature range		Operating: 0 to 50 °C, Storage: -25 to 65 °C (with no icing or condensation)	
	Ambient humidity range		Operating and storage: 35% to 85% (with no condensation)	
	Ambient atmosphere		No corrosive gas	
	Degree of protection		IEC 60529 IP20	
Materials			Plating steel board	
Weight			Approx. 1.8kg	
Accessories			Instruction Manual	

- Note:**
- The number of logged images will vary when connecting multiple Cameras with different models.
  - Do not ground the positive terminal of the 24-VDC power supply to the Lite Controller.  
If the positive terminal is grounded, electrical shock may occur when an SG (0-V) part, such as the case of the Controller or Camera, is touched.
  - The current consumption when the maximum number of Cameras supported by each Controller are connected. If a strobe Controller model is connected to a lamp, the current consumption is as high as when an Intelligent Camera is connected.

## Ratings and Performance

### LCD Monitor

Model	FZ-M08
Size	8.4 inches
Type	Liquid crystal color TFT
Resolution	1,024×768 dots
Input signal	Analog RGB video input, 1 channel
Power supply voltage	21.6 to 26.4 VDC
Current consumption	Approx. 0.7 A max.
Ambient temperature range	Operating: 0 to 50 °C, Storage: -25 to 65 °C (with no icing or condensation)
Ambient humidity range	Operating and storage: 35% to 85% (with no condensation)
Weight	Approx. 1.2 kg
Accessories	Instruction Sheet and 4 mounting brackets

### Monitor Cable

Model	FZ-VM
Vibration resistiveness	10 to 150 Hz single amplitude 0.15 mm 3 directions, 8 strokes, 4 times
Ambient temperature range	Operation: 0 to +50 °C, Storage: -20 to +65 °C (with no icing or condensation)
Ambient humidity range	Operation and storage: 35% to 85%RH (with no condensation)
Ambient atmosphere	No corrosive gases
Material	Cable sheath: heat-resistant PVC Connector: PVC
Minimum bending radius	75 mm
Weight	approx.170 g

### Intelligent Compact Camera

Model	FZ-SQ010F	FZ-SQ050F	FZ-SQ100F	FZ-SQ100N
Field of vision	7.5×4.7 to 13×8.2 mm	13×8.2 to 53×33 mm	53×33 to 240×153 mm	29×18 to 300×191 mm
Installation distance	38 to 60 mm	56 to 215 mm	220 to 970 mm	32 to 380 mm
Image input	Image processing method	Real color		
	Image elements	1/3-inch color CMOS		
	Shutter	1/250 to 1/32258		
	Processing resolution	752 (H) × 480 (V)		
	Partial function	8 to 752 lines		
Lighting	Lighting method	Pulse		
	Lighting color	White		
	LED class	Class 2		
Environmental immunity	Ambient temperature range	Operating: 0 to 50 °C, Storage: -25 to 65 °C (with no icing or condensation)		
	Ambient humidity range	Operating and storage: 35% to 85% (with no condensation)		
	Ambient atmosphere	No corrosive gas		
	Degree of protection	IEC 60529 IP40 (with Polarizing Filter Attachment mounted.)		
Materials	Camera: PBT, PC, SUS Mounting Bracket: PBT Polarizing Filter Attachment: PBT, PC			
Weight	Approx. 160 g		Approx. 150 g	
Accessories	<ul style="list-style-type: none"> <li>• Mounting Bracket (FQ-XL) (1)</li> <li>• Polarizing Filter Attachment (FQ-XF1) (1)</li> <li>• Instruction Manual</li> <li>• Member registration sheet</li> </ul>			

## System configuration

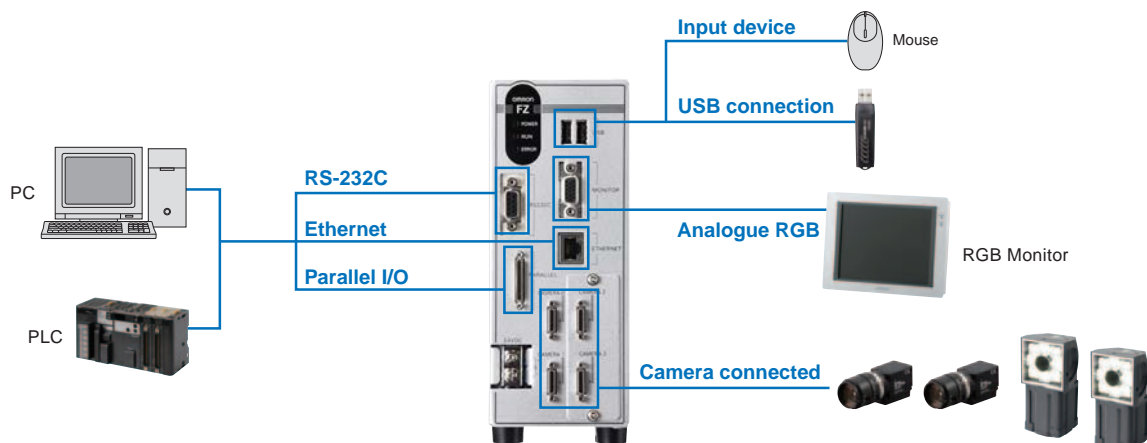

## Controllers

FZ3-L35□  
FZ3-L35□-10

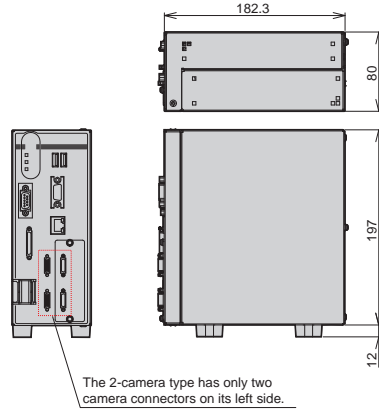

## Intelligent Compact Camera

### Narrow View and Standard

FZ-SQ010F  
FZ-SQ050F

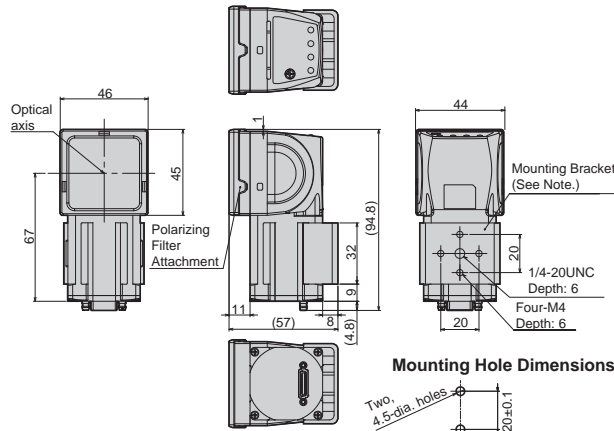

### Wide View

FZ-SQ100F (Long-distance)  
FZ-SQ100N (Short-distance)

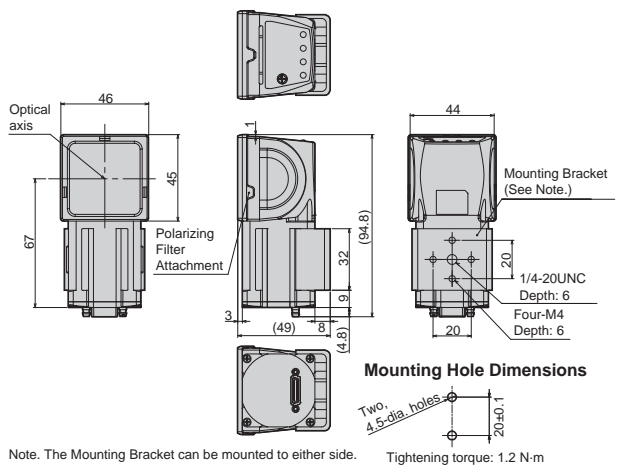

## LCD Monitor

FZ-M08

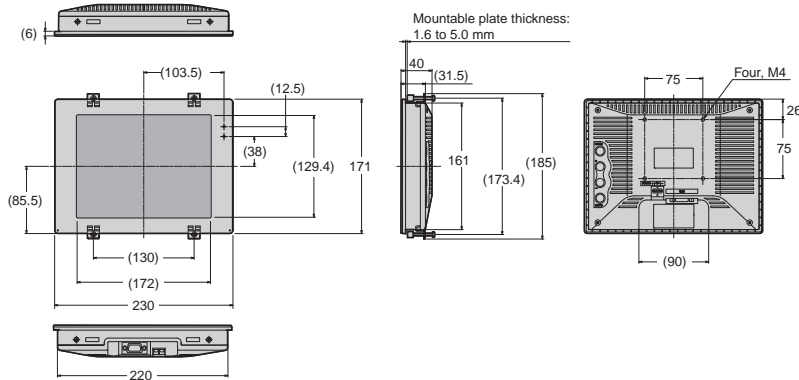



# Optical Chart

## Intelligent Compact Camera

**Narrow View**  
FZ-SQ010F

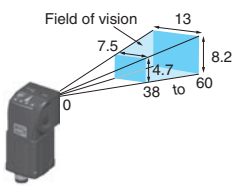

**Standard**  
FZ-SQ050F

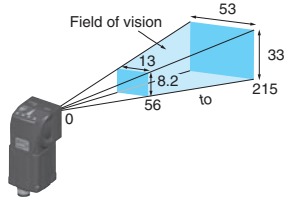

**Wide View (Long-distance)**  
FZ-SQ100F

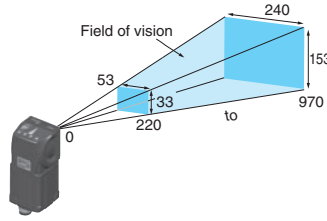

**Wide View (Short-distance)**  
FZ-SQ100N

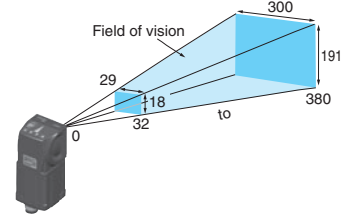

## Intelligent Cameras, Autofocus Cameras

### Narrow View

FZ-SLC15

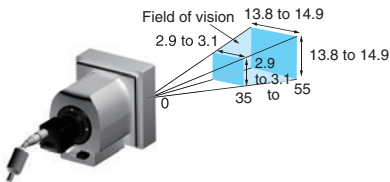

FZ-SZC15

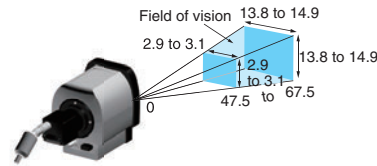

### Wide View

FZ-SLC100

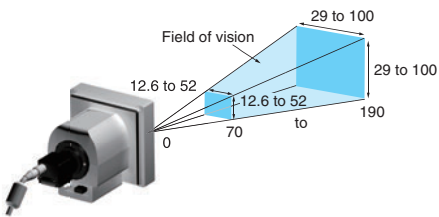

FZ-SZC100

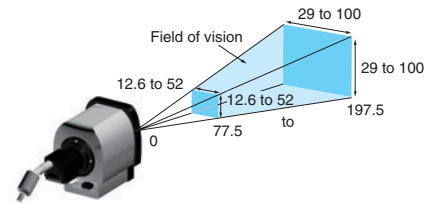

**\* Field of Vision**

The images displayed on the monitor will be rectangular images of 640×480 pixels. The valid processing area for measurements is the 480×480-pixel area in the middle.

The above figures show the dimensions of the middle 480×480 pixels.

## 2 Million-pixel Digital Camera FZ-S□2M

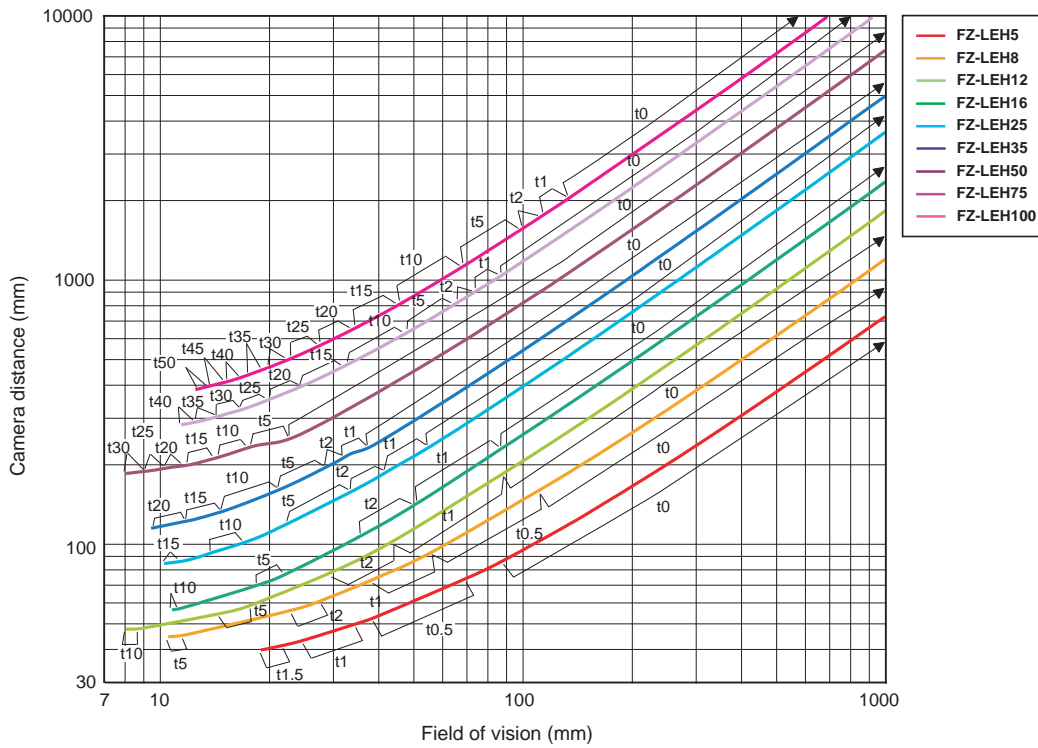

The 5-mm Extension Tubes (3Z4S-LE ML-EXR) cannot be used with FZ-LEH25 Lenses.

## 300,000-pixel Small Digital Cameras FZ-SF□, FZ-SP□

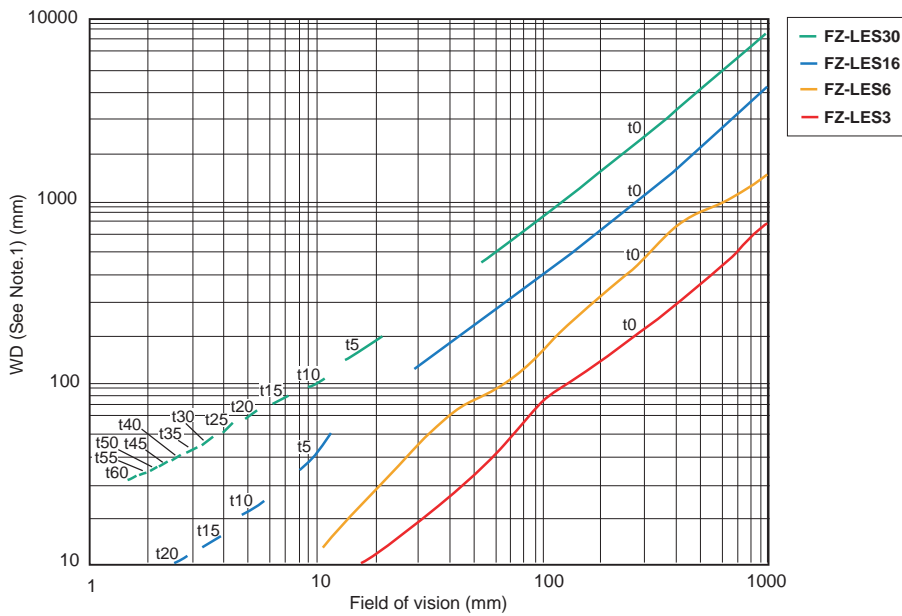

**Note: 1.** The vertical axis represents WD, not installation distance.

**300,000-pixel High-speed Camera, and Digital Camera**  
**FZ-SH□, FZ-S□**

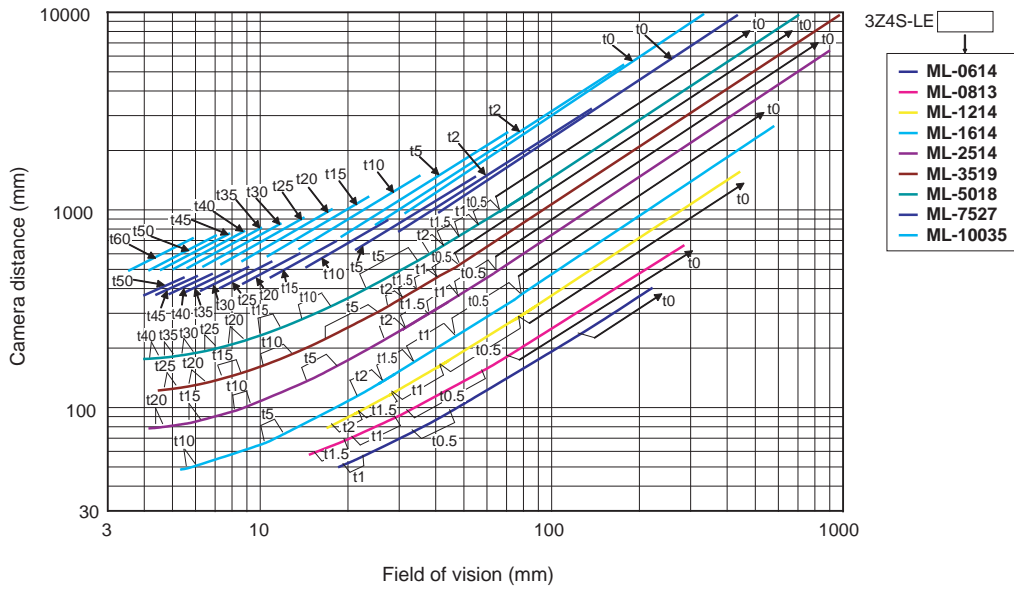

■ **Meaning of Optical Chart**

The X axis of the optical chart shows the field of vision (mm) (Note1), and the Y axis of the optical chart shows the camera installation distance (mm) (Note2).

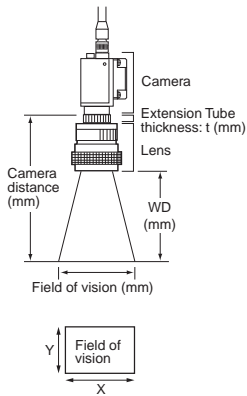

- Note: 1.** The lengths of the fields of vision given in the optical charts are the lengths of the Y axis.
- 2.** The vertical axis represents WD for small cameras.



## **READ AND UNDERSTAND THIS DOCUMENT**

Please read and understand this document before using the products. Please consult your OMRON representative if you have any questions or comments.

## **WARRANTY**

OMRON's exclusive warranty is that the products are free from defects in materials and workmanship for a period of one year (or other period if specified) from date of sale by OMRON.

OMRON MAKES NO WARRANTY OR REPRESENTATION, EXPRESS OR IMPLIED, REGARDING NON-INFRINGEMENT, MERCHANTABILITY, OR FITNESS FOR PARTICULAR PURPOSE OF THE PRODUCTS. ANY BUYER OR USER ACKNOWLEDGES THAT THE BUYER OR USER ALONE HAS DETERMINED THAT THE PRODUCTS WILL SUITABLY MEET THE REQUIREMENTS OF THEIR INTENDED USE. OMRON DISCLAIMS ALL OTHER WARRANTIES, EXPRESS OR IMPLIED.

## **LIMITATIONS OF LIABILITY**

OMRON SHALL NOT BE RESPONSIBLE FOR SPECIAL, INDIRECT, OR CONSEQUENTIAL DAMAGES, LOSS OF PROFITS OR COMMERCIAL LOSS IN ANY WAY CONNECTED WITH THE PRODUCTS, WHETHER SUCH CLAIM IS BASED ON CONTRACT, WARRANTY, NEGLIGENCE, OR STRICT LIABILITY.

In no event shall responsibility of OMRON for any act exceed the individual price of the product on which liability is asserted.

IN NO EVENT SHALL OMRON BE RESPONSIBLE FOR WARRANTY, REPAIR, OR OTHER CLAIMS REGARDING THE PRODUCTS UNLESS OMRON'S ANALYSIS CONFIRMS THAT THE PRODUCTS WERE PROPERLY HANDLED, STORED, INSTALLED, AND MAINTAINED AND NOT SUBJECT TO CONTAMINATION, ABUSE, MISUSE, OR INAPPROPRIATE MODIFICATION OR REPAIR.

## **SUITABILITY FOR USE**

THE PRODUCTS CONTAINED IN THIS DOCUMENT ARE NOT SAFETY RATED. THEY ARE NOT DESIGNED OR RATED FOR ENSURING SAFETY OF PERSONS, AND SHOULD NOT BE RELIED UPON AS A SAFETY COMPONENT OR PROTECTIVE DEVICE FOR SUCH PURPOSES. Please refer to separate catalogs for OMRON's safety rated products.

OMRON shall not be responsible for conformity with any standards, codes, or regulations that apply to the combination of products in the customer's application or use of the product.

At the customer's request, OMRON will provide applicable third party certification documents identifying ratings and limitations of use that apply to the products. This information by itself is not sufficient for a complete determination of the suitability of the products in combination with the end product, machine, system, or other application or use.

The following are some examples of applications for which particular attention must be given. This is not intended to be an exhaustive list of all possible uses of the products, nor is it intended to imply that the uses listed may be suitable for the products:

- Outdoor use, uses involving potential chemical contamination or electrical interference, or conditions or uses not described in this document.
- Nuclear energy control systems, combustion systems, railroad systems, aviation systems, medical equipment, amusement machines, vehicles, safety equipment, and installations subject to separate industry or government regulations.
- Systems, machines, and equipment that could present a risk to life or property.

Please know and observe all prohibitions of use applicable to the products.

NEVER USE THE PRODUCTS FOR AN APPLICATION INVOLVING SERIOUS RISK TO LIFE OR PROPERTY WITHOUT ENSURING THAT THE SYSTEM AS A WHOLE HAS BEEN DESIGNED TO ADDRESS THE RISKS, AND THAT THE OMRON PRODUCT IS PROPERLY RATED AND INSTALLED FOR THE INTENDED USE WITHIN THE OVERALL EQUIPMENT OR SYSTEM.

## **PERFORMANCE DATA**

Performance data given in this document is provided as a guide for the user in determining suitability and does not constitute a warranty. It may represent the result of OMRON's test conditions, and the users must correlate it to actual application requirements. Actual performance is subject to the OMRON Warranty and Limitations of Liability.

## **CHANGE IN SPECIFICATIONS**

Product specifications and accessories may be changed at any time based on improvements and other reasons.

It is our practice to change model numbers when published ratings or features are changed, or when significant construction changes are made. However, some specifications of the product may be changed without any notice. When in doubt, special model numbers may be assigned to fix or establish key specifications for your application on your request. Please consult with your OMRON representative at any time to confirm actual specifications of purchased products.

## **DIMENSIONS AND WEIGHTS**

Dimensions and weights are nominal and are not to be used for manufacturing purposes, even when tolerances are shown.

## **ERRORS AND OMISSIONS**

The information in this document has been carefully checked and is believed to be accurate; however, no responsibility is assumed for clerical, typographical, or proofreading errors, or omissions.

## **PROGRAMMABLE PRODUCTS**

OMRON shall not be responsible for the user's programming of a programmable product, or any consequence thereof.

## **COPYRIGHT AND COPY PERMISSION**

This document shall not be copied for sales or promotions without permission.

This document is protected by copyright and is intended solely for use in conjunction with the product. Please notify us before copying or reproducing this document in any manner, for any other purpose. If copying or transmitting this document to another, please copy or transmit it in its entirety.

**OMRON Corporation** Industrial Automation Company  
Tokyo, JAPAN

Contact: [www.ia.omron.com](http://www.ia.omron.com)

**Regional Headquarters**

**OMRON EUROPE B.V.**

Wegalaan 67-69-2132 JD Hoofddorp  
The Netherlands

Tel: (31)2356-81-300/Fax: (31)2356-81-388

**OMRON ELECTRONICS LLC**

One Commerce Drive Schaumburg,  
IL 60173-5302 U.S.A.

Tel: (1) 847-843-7900/Fax: (1) 847-843-7787

**OMRON ASIA PACIFIC PTE. LTD.**

No. 438A Alexandra Road # 05-05/08 (Lobby 2),  
Alexandra Technopark,  
Singapore 119967

Tel: (65) 6835-3011/Fax: (65) 6835-2711

**OMRON (CHINA) CO., LTD.**

Room 2211, Bank of China Tower,  
200 Yin Cheng Zhong Road,  
PuDong New Area, Shanghai, 200120, China

Tel: (86) 21-5037-2222/Fax: (86) 21-5037-2200

**Authorized Distributor:**

© OMRON Corporation 2009 All Rights Reserved.  
In the interest of product improvement,  
specifications are subject to change without notice.

**CSM\_1\_2\_0311**  
**Cat. No. Q182-E1-01**

Printed in Japan  
1210 (1210) (W)

Компания «Life Electronics» занимается поставками электронных компонентов импортного и отечественного производства от производителей и со складов крупных дистрибьюторов Европы, Америки и Азии.

С конца 2013 года компания активно расширяет линейку поставок компонентов по направлению коаксиальный кабель, кварцевые генераторы и конденсаторы (керамические, пленочные, электролитические), за счёт заключения дистрибьюторских договоров

Мы предлагаем:

- Конкурентоспособные цены и скидки постоянным клиентам.
- Специальные условия для постоянных клиентов.
- Подбор аналогов.
- Поставку компонентов в любых объемах, удовлетворяющих вашим потребностям.
- Приемлемые сроки поставки, возможна ускоренная поставка.
- Доставку товара в любую точку России и стран СНГ.
- Комплексную поставку.
- Работу по проектам и поставку образцов.
- Формирование склада под заказчика.
- Сертификаты соответствия на поставляемую продукцию (по желанию клиента).
- Тестирование поставляемой продукции.
- Поставку компонентов, требующих военную и космическую приемку.
- Входной контроль качества.
- Наличие сертификата ISO.

В составе нашей компании организован Конструкторский отдел, призванный помогать разработчикам, и инженерам.

Конструкторский отдел помогает осуществить:

- Регистрацию проекта у производителя компонентов.
- Техническую поддержку проекта.
- Защиту от снятия компонента с производства.
- Оценку стоимости проекта по компонентам.
- Изготовление тестовой платы монтаж и пусконаладочные работы.



Тел: +7 (812) 336 43 04 (многоканальный)

Email: [org@lifeelectronics.ru](mailto:org@lifeelectronics.ru)