

Tactile Switch B3W

Tactile Switch with Sealed Construction for Automatic Soldering

- Sealed construction conforming to IP67 (IEC-60529) provides high reliability in locations exposed to dust or water.
- Available in two sizes: 6 mm square and 12 mm square
- Dome-shaped contact mechanism assures short key stroke and a sharp click to confirm actuation
- Ground terminal available to protect against static electricity
- Projected plunger types that allow the installation of B32-series Special Key Tops are available.
- RoHS Compliant



Ordering Information

Type	Plunger	Switch height	Operating force	Model	
				Without ground terminal	With ground terminal
				Bags	Bags
Standard 6x6 mm	Flat 	4.3 mm	General-purpose: 160 g	B3W-1000	B3W-1100
			High-force: 230 g	B3W-1002	B3W-1102
	Projected 	7.3 mm	General-purpose: 160 g	B3W-1050	B3W-1150
			High-force: 230 g	B3W-1052	B3W-1152
Standard 12x12 mm	Flat 	4.3 mm	General-purpose: 200 g	B3W-4000	B3W-4100
			High-force: 350 g	B3W-4005	B3W-4105
	Projected 	7.3 mm	General-purpose: 200 g	B3W-4050	B3W-4150
			High-force: 350 g	B3W-4055	B3W-4155

Note: Bulk Packaged, 100 switches per bag. Order in multiples of the package quantity.

Important Note: Switches cannot be water-washed.

■ Accessories

See “B32” Tactile Switch Key Top data sheet for keycaps that fit projected plunger B3W models.

■ Plunger Identification Table

Use this table to determine keyswitch type by plunger color.

Plunger color	Operating force	Type
White	160 g	B3W-1000, 1050, 1100, 1150
White	200 g	B3W-4000, 4050, 4100, 4150
Yellow	230 g	B3W-1002, 1052, 1102, 1152
Yellow	350 g	B3W-4005, 4055, 4105, 4155

Specifications

■ Characteristics

Contact form		SPST-NO	
Switching capacity		1 to 50 mA, 5 to 24 VDC (resistive load)	
Contact resistance		100 mΩ max. (rated: 1 mA, 5 VDC)	
Insulation resistance		100 MΩ min. (at 250 VDC)	
Dielectric strength		500 VAC, 50/60 Hz for 1 min.	
Bounce time		5 ms max.	
Vibration resistance		Malfunction: 10 to 55 Hz, 1.5-mm double amplitude	
Shock resistance		Destruction: 1,000 m/s ² (approx. 100 G) max. Malfunction: 100 m/s ² (approx. 10 G) max.	
Ambient operating temperature		-25° to 70°C (at 60% RH max.) with no icing or condensation	
Ambient operating humidity		35% to 85% (at 5 to 35°C)	
Service life	General purpose	B3W-1□□□ : 1,000,000 operations min.	B3W-4□□□ : 3,000,000 operations min.
	High force	300,000 operations min.	1,000,000 operations min.
Weight		B3W-1□□□ : Approx. 0.30 g	B3W-4□□□ : Approx. 1.00 g

■ Operating Characteristics

Characteristics	B3W-1□□□		B3W-4□□□	
	General-purpose	High-force	General-purpose	High-force
Operating force (OF) max.	160 g	230 g	200 g	350 g
Release force (RF) min.	20 g	50 g	30 g	50 g
Pretravel (PT)	0.25 ^{+0.2} / _{-0.1} mm		0.3 ^{+0.2} / _{-0.1} mm	

Engineering Data

■ Operating Force vs. Stroke (Typical Example)

B3W-1□□□ series



B3W-4□□□ series

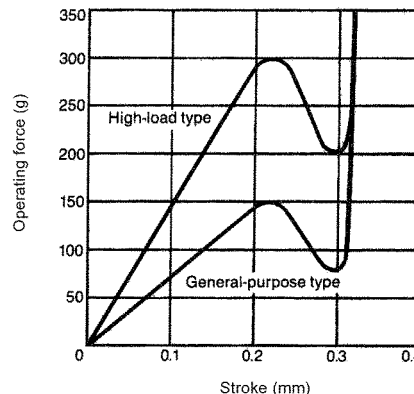

■ Construction

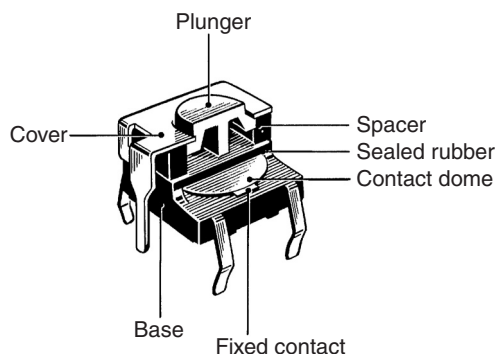

Dimensions

- Note:** 1. Unless otherwise specified, all units are in millimeters and a tolerance of ± 0.4 mm applies to all dimensions.
 2. Terminal numbers are not indicated on this switch. With the switch turned over so that the logo mark "OMRON" is visible on the upper part of the rear side of the switch base, the terminal on the right of the logo mark is numbered "1" and that on the bottom right is "3." Accordingly, two terminals on the left side are numbered "2" and "4" respectively.

6 x 6 mm Models

Flat Plunger Type (without Ground Terminal)

B3W-1000
B3W-1002



Flat Plunger Type (with Ground Terminal)

B3W-1100
B3W-1102

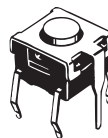

PCB Mounting (Top View)
(Single-sided PCB, t=1.6)

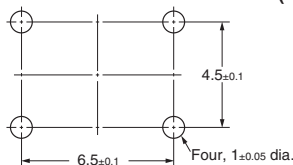

Terminal Arrangement /Internal Connections (Top View)

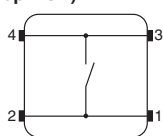

PCB Mounting (Top View)
(Single-sided PCB, t=1.6)



Terminal Arrangement /Internal Connections (Top View)

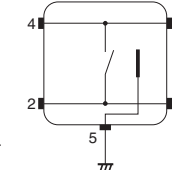

Projected Plunger Type (without Ground Terminal)

B3W-1050
B3W-1052



Projected Plunger Type (with Ground Terminal)

B3W-1150
B3W-1152

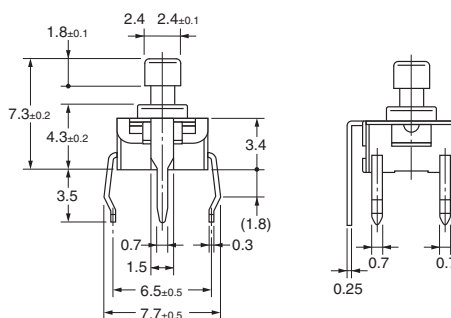
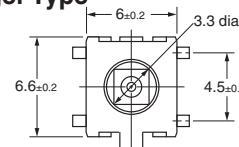

PCB Mounting (Top View)
(Single-sided PCB, t=1.6)



Terminal Arrangement /Internal Connections (Top View)

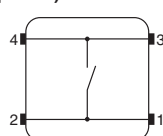

PCB Mounting (Top View)
(Single-sided PCB, t=1.6)



Terminal Arrangement /Internal Connections (Top View)

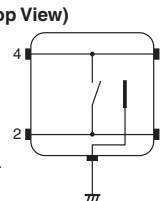

12 x 12 mm Models

Flat Plunger Type
(without Ground Terminal)

B3W-4000
B3W-4005

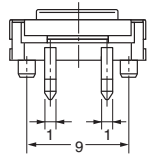
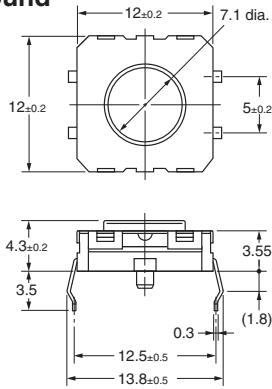
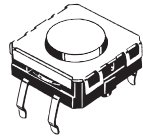

PCB Mounting (Top View)
(Single-sided PCB, t=1.6)

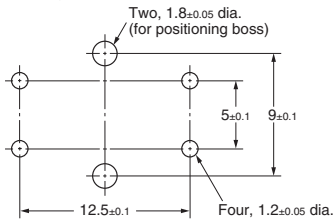

Terminal Arrangement
/Internal Connections
(Top View)

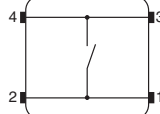

Flat Plunger Type
(with Ground Terminal)

B3W-4100
B3W-4105

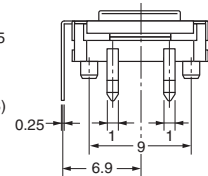
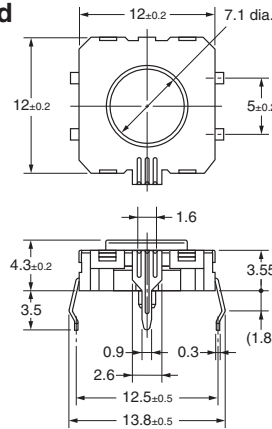
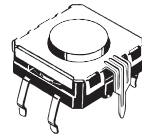

PCB Mounting (Top View)
(Single-sided PCB, t=1.6)

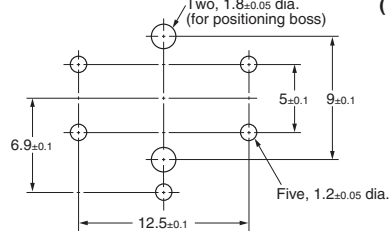

Terminal Arrangement
/Internal Connections
(Top View)

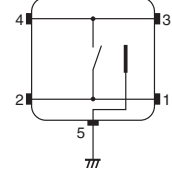

Projected Plunger Type
(without Ground Terminal)

B3W-4050
B3W-4055

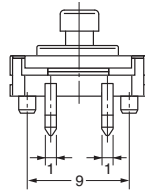
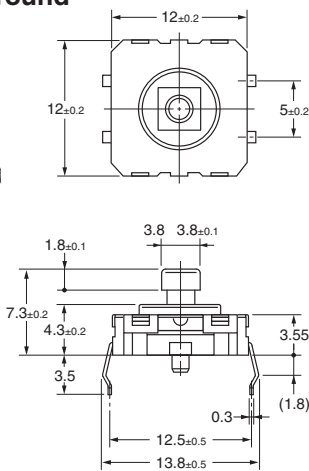
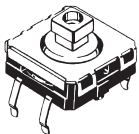

PCB Mounting (Top View)
(Single-sided PCB, t=1.6)

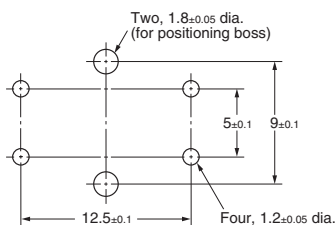

Terminal Arrangement
/Internal Connections
(Top View)

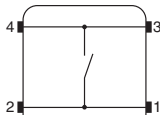

Projected Plunger Type
(with Ground Terminal)

B3W-4150
B3W-4155

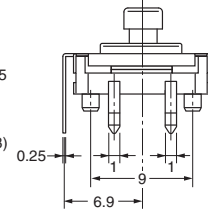
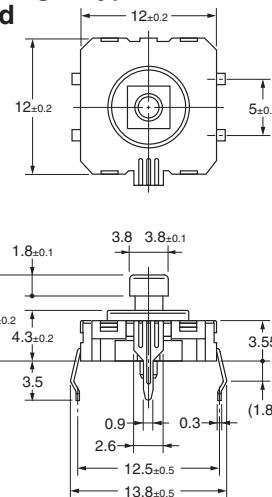
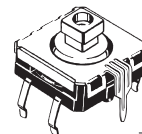

PCB Mounting (Top View)
(Single-sided PCB, t=1.6)

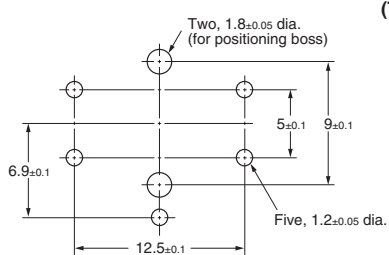

Terminal Arrangement
/Internal Connections
(Top View)

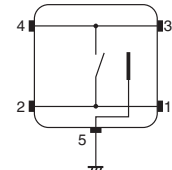

Precautions

Be sure to read the precautions common to all Tactile Switches, contained in the Technical User's Guide, "Tactile Switches, Technical Information" for correct use.



All sales are subject to Omron Electronic Components LLC standard terms and conditions of sale, which can be found at http://www.components.omron.com/components/web/webfiles.nsf/sales_terms.html

ALL DIMENSIONS SHOWN ARE IN MILLIMETERS.
To convert millimeters into inches, multiply by 0.03937. To convert grams into ounces, multiply by 0.03527.

OMRON[®]

**OMRON ELECTRONIC
COMPONENTS LLC**

55 E. Commerce Drive, Suite B
Schaumburg, IL 60173

847-882-2288

OMRON ON-LINE

Global - <http://www.omron.com>

USA - <http://www.components.omron.com>

Компания «Life Electronics» занимается поставками электронных компонентов импортного и отечественного производства от производителей и со складов крупных дистрибьюторов Европы, Америки и Азии.

С конца 2013 года компания активно расширяет линейку поставок компонентов по направлению коаксиальный кабель, кварцевые генераторы и конденсаторы (керамические, пленочные, электролитические), за счёт заключения дистрибьюторских договоров

Мы предлагаем:

- Конкурентоспособные цены и скидки постоянным клиентам.
- Специальные условия для постоянных клиентов.
- Подбор аналогов.
- Поставку компонентов в любых объемах, удовлетворяющих вашим потребностям.
- Приемлемые сроки поставки, возможна ускоренная поставка.
- Доставку товара в любую точку России и стран СНГ.
- Комплексную поставку.
- Работу по проектам и поставку образцов.
- Формирование склада под заказчика.
- Сертификаты соответствия на поставляемую продукцию (по желанию клиента).
- Тестирование поставляемой продукции.
- Поставку компонентов, требующих военную и космическую приемку.
- Входной контроль качества.
- Наличие сертификата ISO.

В составе нашей компании организован Конструкторский отдел, призванный помогать разработчикам, и инженерам.

Конструкторский отдел помогает осуществить:

- Регистрацию проекта у производителя компонентов.
- Техническую поддержку проекта.
- Защиту от снятия компонента с производства.
- Оценку стоимости проекта по компонентам.
- Изготовление тестовой платы монтаж и пусконаладочные работы.



Тел: +7 (812) 336 43 04 (многоканальный)
Email: org@lifeelectronics.ru