

# IGBT Trench Module

 $V_{CES} = 1700\text{ V}$ 
 $I_{C25} = 400\text{ A}$ 
 $V_{CE(sat)} = 2\text{ V}$ 

Boost/Brake Chopper + free wheeling Diode + NTC

Part number

**MITA300RF1700PTED**

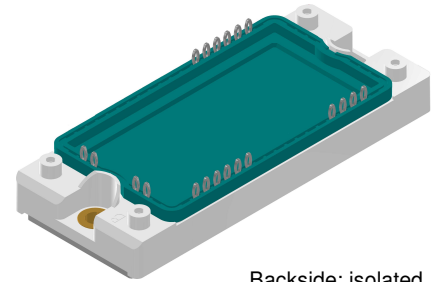

Backside: isolated

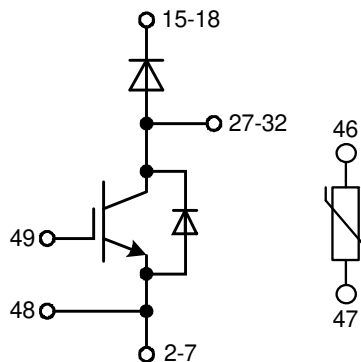

### Features / Advantages:

- Brake with Infineon IGBT<sup>3</sup>

### Applications:

- AC motor drives
- Solar inverter
- Medical equipment
- Uninterruptible power supply
- Air-conditioning systems
- Welding equipment
- Switched-mode and resonant-mode power supplies
- Inductive heating, cookers
- Pumps, Fans

### Package: E2-Pack

- Isolation Voltage: 3600 V~
- Industry standard outline
- RoHS compliant
- PressFit-Pins for PCB mounting
- Height: 17 mm
- Base plate: Copper internally DCB isolated
- Advanced power cycling
- Phase Change Material available

### Terms and Conditions of Usage

The data contained in this product data sheet is exclusively intended for technically trained staff. The user will have to evaluate the suitability of the product for the intended application and the completeness of the product data with respect to his application. The specifications of our components may not be considered as an assurance of component characteristics. The information in the valid application- and assembly notes must be considered. Should you require product information in excess of the data given in this product data sheet or which concerns the specific application of your product, please contact your local sales office.

Due to technical requirements our product may contain dangerous substances. For information on the types in question please contact your local sales office.

Should you intend to use the product in aviation, in health or life endangering or life support applications, please notify. For any such application we urgently recommend

- to perform joint risk and quality assessments;

- the conclusion of quality agreements;

- to establish joint measures of an ongoing product survey, and that we may make delivery dependent on the realization of any such measures.

Free Wheeling Diode FWD				Ratings			
Symbol	Definition	Conditions	min.	typ.	max.	Unit	
$V_{RSM}$	max. non-repetitive reverse blocking voltage				1700	V	
$V_{RRM}$	max. repetitive reverse blocking voltage				1700	V	
$I_R$	reverse current, drain current	$V_R = 1700\text{ V}$			100	$\mu\text{A}$	
	* not applicable, see Ices at IGBT	$V_R = 1700\text{ V}$			0.8	mA	
$V_F$	forward voltage drop	$I_F = 40\text{ A}$			2.20	V	
		$I_F = 80\text{ A}$			2.75	V	
		$I_F = 40\text{ A}$	$T_{VJ} = 125^\circ\text{C}$			2.30	V
		$I_F = 80\text{ A}$				3.15	V
$I_{FAV}$	average forward current	$T_C = 80^\circ\text{C}$ rectangular $d = 0.5$			40	A	
$V_{F0}$	threshold voltage	} for power loss calculation only			1.35	V	
$r_F$	slope resistance				23	m $\Omega$	
$R_{thJC}$	thermal resistance junction to case				1	K/W	
$R_{thCH}$	thermal resistance case to heatsink			0.30		K/W	
$P_{tot}$	total power dissipation				125	W	
$I_{FSM}$	max. forward surge current	$t = 10\text{ ms}; (50\text{ Hz}), \text{ sine}; V_R = 0\text{ V}$			300	A	
$C_J$	junction capacitance	$V_R = 900\text{ V}$ $f = 1\text{ MHz}$			14	pF	

Boost IGBT				Ratings			
Symbol	Definition	Conditions	min.	typ.	max.	Unit	
$V_{CES}$	collector emitter voltage				1700	V	
$V_{GES}$	max. DC gate voltage				±20	V	
$V_{GEM}$	max. transient gate emitter voltage				±30	V	
$I_{C25}$	collector current				400	A	
$I_{C80}$					280	A	
$P_{tot}$	total power dissipation				1390	W	
$V_{CE(sat)}$	collector emitter saturation voltage	$I_C = 300A; V_{GE} = 15V$			2	V	
					2.4	V	
$V_{GE(th)}$	gate emitter threshold voltage	$I_C = 12mA; V_{GE} = V_{CE}$	5.2	5.8	6.4	V	
$I_{CES}$	collector emitter leakage current	$V_{CE} = V_{CES}; V_{GE} = 0V$			1.2	mA	
					1.4	mA	
$I_{GES}$	gate emitter leakage current	$V_{GE} = ±20V$			800	nA	
$Q_{G(on)}$	total gate charge	$V_{CE} = 900V; V_{GE} = 15V; I_C = 300A$		3400		nC	
$t_{d(on)}$	turn-on delay time	inductive load $V_{CE} = 900V; I_C = 300A$ $V_{GE} = ±15V; R_G = 4.7Ω$		340		ns	
$t_r$	current rise time			90		ns	
$t_{d(off)}$	turn-off delay time			800		ns	
$t_f$	current fall time			400		ns	
$E_{on}$	turn-on energy per pulse			100		mJ	
$E_{off}$	turn-off energy per pulse			75		mJ	
<b>RBSOA</b>	reverse bias safe operating area	$V_{GE} = ±15V; R_G = 4.7Ω$					
$I_{CM}$		$V_{CEmax} = 1700V$			600	A	
<b>SCSOA</b>	short circuit safe operating area	$V_{CEmax} = 1700V$					
$t_{SC}$	short circuit duration	$V_{CE} = 900V; V_{GE} = ±15V$			10	μs	
$I_{SC}$	short circuit current	$R_G = 4.7Ω; \text{non-repetitive}$		1600		A	
$R_{thJC}$	thermal resistance junction to case				0.09	K/W	
$R_{thCH}$	thermal resistance case to heatsink				0.03	K/W	
<b>Boost Diode BD</b>							
$V_{RRM}$	max. repetitive reverse voltage				1700	V	
$I_{F25}$	forward current				400	A	
$I_{F80}$					300	A	
$V_F$	forward voltage	$I_F = 300A$			2.20	V	
					2.00	V	
$I_R$	reverse current	$V_R = V_{RRM}$			1.2	mA	
					1.2	mA	
$Q_{rr}$	reverse recovery charge	$V_R = 900V$ $-di_F/dt = 3000A/μs$ $I_F = 300A; V_{GE} = 0V$		80		μC	
$I_{RM}$	max. reverse recovery current			300		A	
$t_{rr}$	reverse recovery time			950		ns	
$E_{rec}$	reverse recovery energy			40		mJ	
$R_{thJC}$	thermal resistance junction to case				0.14	K/W	
$R_{thCH}$	thermal resistance case to heatsink				0.05	K/W	

Package E2-Pack		Ratings				
Symbol	Definition	Conditions	min.	typ.	max.	Unit
$I_{RMS}$	RMS current	per terminal			30	A
$T_{VJ}$	virtual junction temperature		-40		150	°C
$T_{op}$	operation temperature		-40		125	°C
$T_{stg}$	storage temperature		-40		125	°C
<b>Weight</b>				176		g
$M_D$	mounting torque		3		6	Nm
$d_{Spp/App}$	creepage distance on surface / striking distance through air	terminal to terminal	6.0			mm
$d_{Spb/Apb}$		terminal to backside	12.0			mm
$V_{ISOL}$	isolation voltage	t = 1 second 50/60 Hz, RMS; $I_{ISOL} \leq 1$ mA	3600			V
		t = 1 minute	3000			V
$R_{pin-chip}$	resistance pin to chip	$V = V_{CEsat} + 2 \cdot R \cdot I_C$ resp. $V = V_F + 2 \cdot R \cdot I_F$		2.5		mΩ

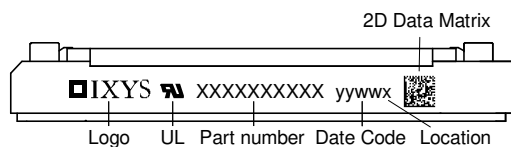

**Part description**

- M = Module
- I = IGBT
- T = IGBT Trench
- A = Gen 3 / std
- 300 = Current Rating [A]
- RF = Boost/Brake Chopper + free wheeling Diode
- 1700 = Reverse Voltage [V]
- PT = PressFit-Pin, Thermistor
- ED = E2-Pack
- = Hyphen
- PC = Phase Change Material

Ordering	Ordering Number	Marking on Product	Delivery Mode	Quantity	Code No.
Standard	MITA300RF1700PTED	MITA300RF1700PTED	Blister	28	516670
Alternative	MITA300RF1700PTED-PC	MITA300RF1700PTED	Blister	28	515402

**Temperature Sensor NTC**

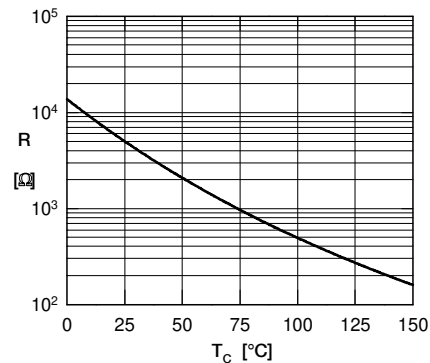
Symbol	Definition	Conditions	min.	typ.	max.	Unit
$R_{25}$	resistance	$T_{VJ} = 25^\circ$	4.85	5	5.15	kΩ
$B_{25/50}$	temperature coefficient			3375		K



## Outlines E2-Pack

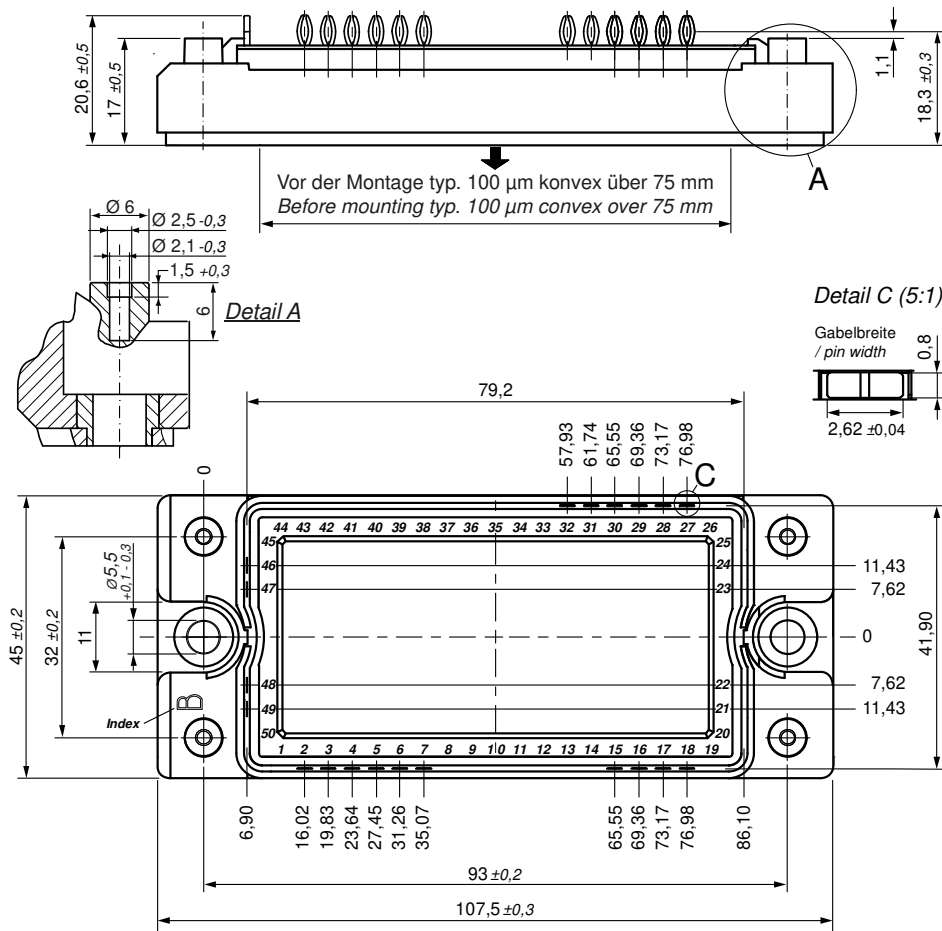

### Bemerkung / Note:

- Nicht tolerierte Maße nach / Measure without tolerances according DIN ISO 2768-T1-m
- PCB-Lochmuster / PCB hole pattern: **see pin position**
- Toleranz Pin-Position und PCB-Lochmuster / Tolerance of pin position and PCB hole pattern:  $\oplus 0.1$
- Bohrlochdurchmesser / Diameter of drill: **Ø 2.35 mm**
- Endlochdurchmesser / Diameter of plated holes: **Ø 2.14 - 2.29 mm** (Cu thickness in via typ. 50 µm)
- Beschichtung / Plating: **chem. Sn max. 15 µm**
- Einpresskraft / Insert Force: per terminal with a typ. insert speed of 7 mm/s: **typ. 90 N**
- Weitere Angaben / Further information: [www.ixys.com](http://www.ixys.com) **Application note IXAN0077**
- Montageanleitung / Mounting instruction: [www.ixys.com](http://www.ixys.com) **Application note IXAN0024**

### Detail A: PCB-Montage / Mounting on PCB<sup>L</sup>

- Empfohlene, selbstschneidende Schraube / Recommended, self-tapping screw: **EJOT PT®** (Größe / size: **K25**)<sup>L</sup>
- Max. Schraubenlänge / Max. screw length: **PCB-Dicke / thickness + 6 mm** (max. Lochtiefe / hole depth)<sup>L</sup>
- Empfohlenes Drehmoment / Recommended mounting torque: **1.5 Nm**

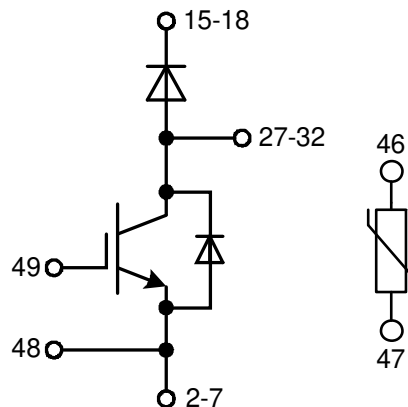

## Boost IGBT

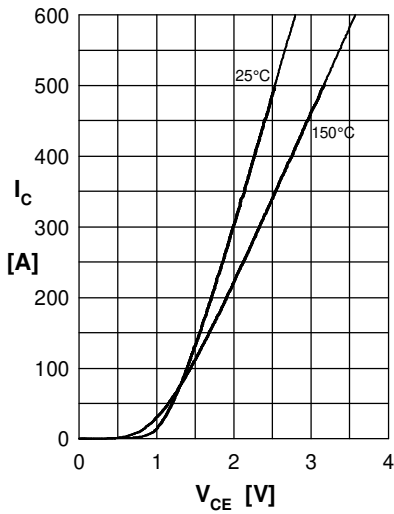

Fig. 1 Typ. output characteristics IGBT

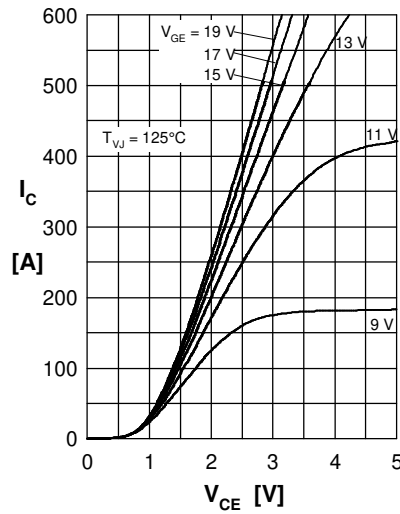

Fig. 2 Typ. output characteristics IGBT

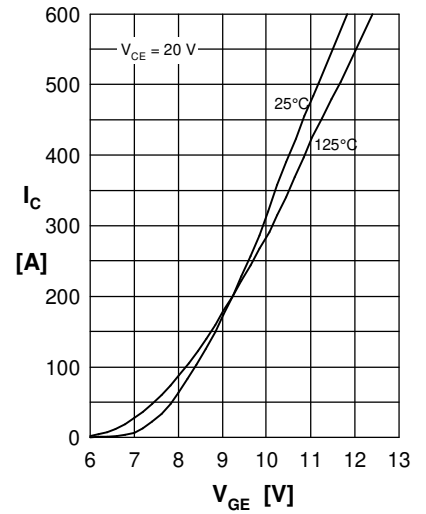

Fig. 3 Typ. transfer charact. IGBT

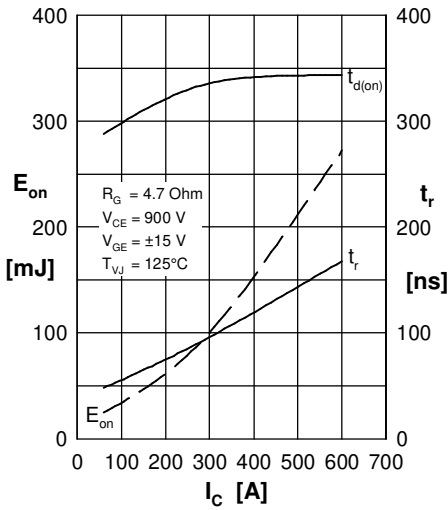

Fig. 4 Typ. turn-on energy & switch times vs. collector current

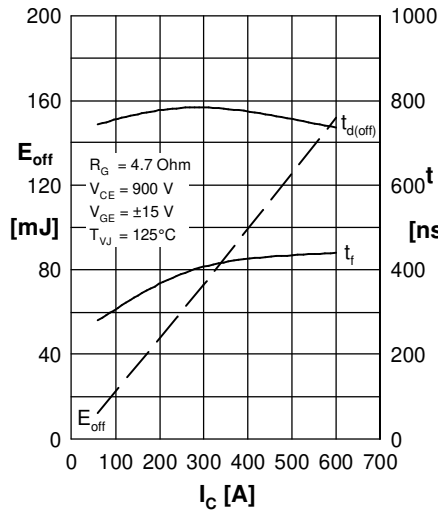

Fig. 5 Typ. turn-off energy & switch times vs. collector current

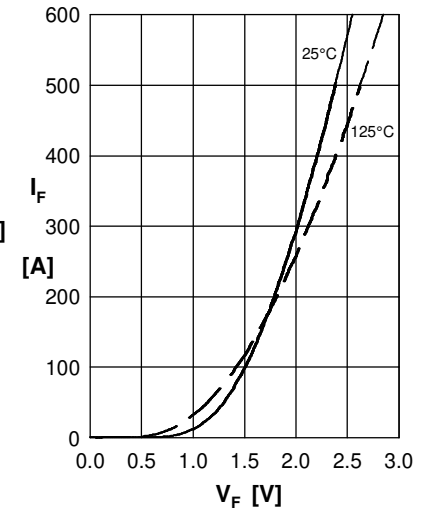

Fig. 6 Typ. forward characteristics Diode

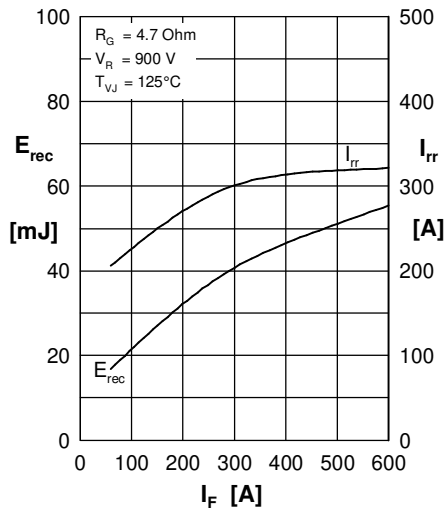

Fig. 7 Typ. reverse recovery characteristics Diode

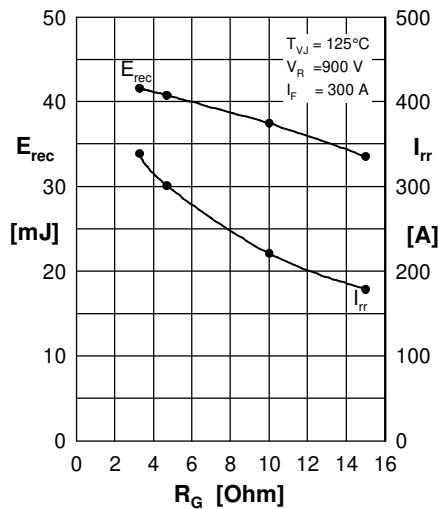

Fig. 8 Typ. reverse recovery characteristics Diode

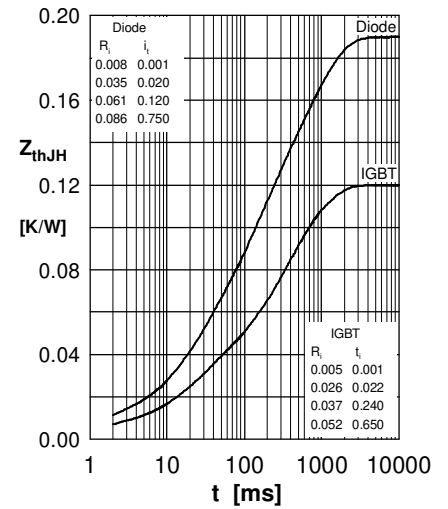

Fig. 9 Typ. transient thermal resistance junction to heatsink

Компания «Life Electronics» занимается поставками электронных компонентов импортного и отечественного производства от производителей и со складов крупных дистрибьюторов Европы, Америки и Азии.

С конца 2013 года компания активно расширяет линейку поставок компонентов по направлению коаксиальный кабель, кварцевые генераторы и конденсаторы (керамические, пленочные, электролитические), за счёт заключения дистрибьюторских договоров

Мы предлагаем:

- Конкуренеспособные цены и скидки постоянным клиентам.
- Специальные условия для постоянных клиентов.
- Подбор аналогов.
- Поставку компонентов в любых объемах, удовлетворяющих вашим потребностям.
- Приемлемые сроки поставки, возможна ускоренная поставка.
- Доставку товара в любую точку России и стран СНГ.
- Комплексную поставку.
- Работу по проектам и поставку образцов.
- Формирование склада под заказчика.
- Сертификаты соответствия на поставляемую продукцию (по желанию клиента).
- Тестирование поставляемой продукции.
- Поставку компонентов, требующих военную и космическую приемку.
- Входной контроль качества.
- Наличие сертификата ISO.

В составе нашей компании организован Конструкторский отдел, призванный помогать разработчикам, и инженерам.

Конструкторский отдел помогает осуществить:

- Регистрацию проекта у производителя компонентов.
- Техническую поддержку проекта.
- Защиту от снятия компонента с производства.
- Оценку стоимости проекта по компонентам.
- Изготовление тестовой платы монтаж и пусконаладочные работы.

