

TUHS3

TUH S 3 F 05

① ② ③ ④ ⑤



- ① Series name
- ② Single output
- ③ Output wattage
- ④ Universal Input
- ⑤ Output voltage

□ Class II

* Avoid short circuit between +BC and -BC. It may cause the failure of inside components.
 * To use TUHS, external components are required. Refer to the instruction manual for details.

| MODEL | TUHS3F05 | TUHS3F12 | TUHS3F24 |
|-----------------------|----------|-----------|-----------|
| MAX OUTPUT WATTAGE[W] | 3.00 | 3.00 | 3.12 |
| DC OUTPUT | 5V 0.6A | 12V 0.25A | 24V 0.13A |

SPECIFICATIONS

| | MODEL | TUHS3F05 | TUHS3F12 | TUHS3F24 | |
|-------------------------------|---|---|-------------------|---------------|--------|
| INPUT | VOLTAGE[V] | AC85 - 264 1 φ DC120 - 370 | | | |
| | CURRENT[A] | ACIN 100V | 0.08typ (Io=100%) | | |
| | | ACIN 200V | 0.05typ (Io=100%) | | |
| | FREQUENCY[Hz] | 50/60 (47 - 63) | | | |
| | EFFICIENCY[%] | ACIN 100V | 79typ | 81typ | 81typ |
| | | ACIN 200V | 78typ | 79typ | 79typ |
| INRUSH CURRENT | Limited by external components | | | | |
| LEAKAGE CURRENT[ma] | 0.40/0.75 max (ACIN100V/240V , 60Hz, Io=100% , According to IEC60950-1) | | | | |
| OUTPUT | VOLTAGE[V] | 5 | 12 | 24 | |
| | CURRENT[A] | 0.6 | 0.25 | 0.13 | |
| | LINE REGULATION[mV] | 20max | 48max | 96max | |
| | LOAD REGULATION[mV] | 40max | 100max | 150max | |
| | RIPPLE[mVp-p] | 30 to 100% Load *1 | 120max | 160max | 200max |
| | | 0 to 30% Load AC85V - 240V *1 | 400max | 480max | 580max |
| | RIPPLE NOISE[mVp-p] | 30 to 100% Load *1 | 160max | 200max | 240max |
| | | 0 to 30% Load AC85V - 240V *1 | 480max | 560max | 660max |
| | TEMPERATURE REGULATION[mV] | 0 to +85°C | 100max | 180max | 360max |
| | | -40 to +85°C | 150max | 270max | 480max |
| DRIFT[mV] | *2 | 20max | 48max | 96max | |
| OUTPUT VOLTAGE SETTING[V] | 4.90 - 5.30 | 11.40 - 12.60 | 23.00 - 25.00 | | |
| PROTECTION CIRCUIT AND OTHERS | OVERCURRENT PROTECTION | Works over 105% of rating and recover automatically | | | |
| | OVERVOLTAGE PROTECTION[V] | 5.50 - 8.00 | 13.20 - 19.20 | 26.40 - 38.40 | |
| ISOLATION | INPUT-OUTPUT | AC3,000V 1minute, Cutoff current = 10mA, DC500V 50MΩ min (20±15°C) | | | |
| ENVIRONMENT | OPERATING TEMP., HUMID. AND ALTITUDE | -40 to +85°C, 20 - 95%RH (Non condensing) (Refer to DERATING CURVE), 3,000m (10,000 feet) max | | | |
| | STORAGE TEMP., HUMID. AND ALTITUDE | -40 to +100°C, 20 - 95%RH (Non condensing), 9,000m (30,000 feet) max | | | |
| | VIBRATION | 10 - 55Hz, 49.0m/s ² (5G), 3minutes period, 60minutes each along X, Y and Z axis | | | |
| | IMPACT | 196.1m/s ² (20G), 11ms, once each along X, Y and Z axis | | | |
| SAFETY AND NOISE REGULATIONS | AGENCY APPROVALS | UL60950-1, C-UL (CSA60950-1), EN60950-1 | | | |
| | CONDUCTED NOISE | Complies with FCC-B, VCCI-B, CISPR-B, EN55022-B *3 | | | |
| | HARMONIC ATTENUATOR | Complies with IEC61000-3-2 (Class A) (Not built-in to active filter) | | | |
| OTHERS | CASE SIZE/WEIGHT | 28.7 X 12.7 X 17.5mm [1.13 X 0.50 X 0.69 inches] (W X H X D) / 15g max | | | |
| | COOLING METHOD | Convection / Forced air | | | |

*1 Refer to instruction manual for measuring method of electric characteristics.
 *2 Drift is the change in DC output for an eight hour period after a half-hour warm-up at 25°C, with the input voltage held constant at the rated value.
 *3 Do not ground secondly circuit, in case of a standard adapted.
 * Measured with 18μF capacitor as Cbc.

External view

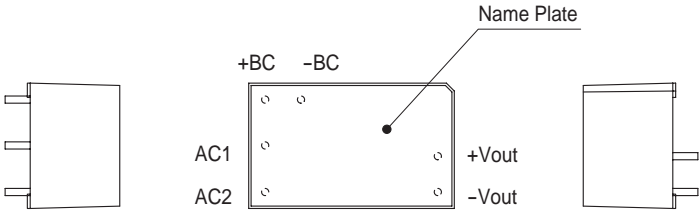

- ※ Tolerance : ± 0.5 [± 0.02]
- ※ Weight : 15g max
- ※ Case material : PBT
- ※ Pin material : Copper
- ※ Plating treatment of pin : Lead free plating
- ※ Dimensions in mm, []=inches

TUHS5

TUH S 5 F 05

① ② ③ ④ ⑤

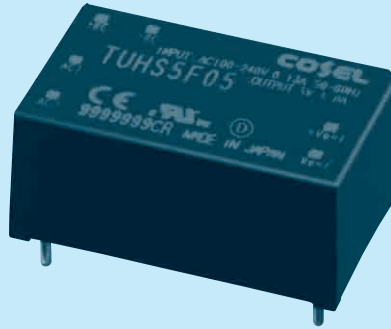

- ① Series name
- ② Single output
- ③ Output wattage
- ④ Universal Input
- ⑤ Output voltage

□ Class II

* Avoid short circuit between +BC and -BC. It may cause the failure of inside components.
 * To use TUHS, external components are required. Refer to the instruction manual for details.

| MODEL | TUHS5F05 | TUHS5F12 | TUHS5F24 |
|-----------------------|----------|-----------|-----------|
| MAX OUTPUT WATTAGE[W] | 5.00 | 5.40 | 5.28 |
| DC OUTPUT | 5V 1A | 12V 0.45A | 24V 0.22A |

SPECIFICATIONS

| | MODEL | TUHS5F05 | TUHS5F12 | TUHS5F24 | |
|-------------------------------|---|---|-------------------|---------------|--------|
| INPUT | VOLTAGE[V] | AC85 - 264 1 φ DC120 - 370 | | | |
| | CURRENT[A] | ACIN 100V | 0.13typ (Io=100%) | | |
| | | ACIN 200V | 0.08typ (Io=100%) | | |
| | FREQUENCY[Hz] | 50/60 (47 - 63) | | | |
| | EFFICIENCY[%] | ACIN 100V | 78typ | 82typ | 83typ |
| | | ACIN 200V | 79typ | 82typ | 83typ |
| INRUSH CURRENT | Limited by external components | | | | |
| LEAKAGE CURRENT[ma] | 0.40/0.75 max (ACIN100V/240V , 60Hz, Io=100% , According to IEC60950-1) | | | | |
| OUTPUT | VOLTAGE[V] | 5 | 12 | 24 | |
| | CURRENT[A] | 1 | 0.45 | 0.22 | |
| | LINE REGULATION[mV] | 20max | 48max | 96max | |
| | LOAD REGULATION[mV] | 40max | 100max | 150max | |
| | RIPPLE[mVp-p] | 30 to 100% Load *1 | 120max | 160max | 200max |
| | | 0 to 30% Load AC85V - 240V *1 | 400max | 480max | 580max |
| | RIPPLE NOISE[mVp-p] | 30 to 100% Load *1 | 160max | 200max | 240max |
| | | 0 to 30% Load AC85V - 240V *1 | 480max | 560max | 660max |
| | TEMPERATURE REGULATION[mV] | 0 to +80°C | 100max | 180max | 360max |
| | | -40 to +80°C | 150max | 270max | 480max |
| DRIFT[mV] | *2 | 20max | 48max | 96max | |
| OUTPUT VOLTAGE SETTING[V] | 4.90 - 5.30 | 11.40 - 12.60 | 23.00 - 25.00 | | |
| PROTECTION CIRCUIT AND OTHERS | OVERCURRENT PROTECTION | Works over 105% of rating and recover automatically | | | |
| | OVERVOLTAGE PROTECTION[V] | 5.50 - 8.00 | 13.20 - 19.20 | 26.40 - 38.40 | |
| ISOLATION | INPUT-OUTPUT | AC3,000V 1minute, Cutoff current = 10mA, DC500V 50MΩ min (20±15°C) | | | |
| ENVIRONMENT | OPERATING TEMP., HUMID. AND ALTITUDE | -40 to +85°C, 20 - 95%RH (Non condensing) (Refer to DERATING CURVE), 3,000m (10,000 feet) max | | | |
| | STORAGE TEMP., HUMID. AND ALTITUDE | -40 to +100°C, 20 - 95%RH (Non condensing), 9,000m (30,000 feet) max | | | |
| | VIBRATION | 10 - 55Hz, 49.0m/s ² (5G), 3minutes period, 60minutes each along X, Y and Z axis | | | |
| | IMPACT | 196.1m/s ² (20G), 11ms, once each along X, Y and Z axis | | | |
| SAFETY AND NOISE REGULATIONS | AGENCY APPROVALS | UL60950-1, C-UL (CSA60950-1), EN60950-1 | | | |
| | CONDUCTED NOISE | Complies with FCC-B, VCCI-B, CISPR-B, EN55022-B *3 | | | |
| | HARMONIC ATTENUATOR | Complies with IEC61000-3-2 (Class A) (Not built-in to active filter) | | | |
| OTHERS | CASE SIZE/WEIGHT | 28.7 X 12.7 X 17.5mm [1.13 X 0.50 X 0.69 inches] (W X H X D) / 15g max | | | |
| | COOLING METHOD | Convection / Forced air | | | |

*1 Refer to instruction manual for measuring method of electric characteristics.
 *2 Drift is the change in DC output for an eight hour period after a half-hour warm-up at 25°C, with the input voltage held constant at the rated value.
 *3 Do not ground secondly circuit, in case of a standard adapted.
 * Measured with 22μF capacitor as Cbc.

External view

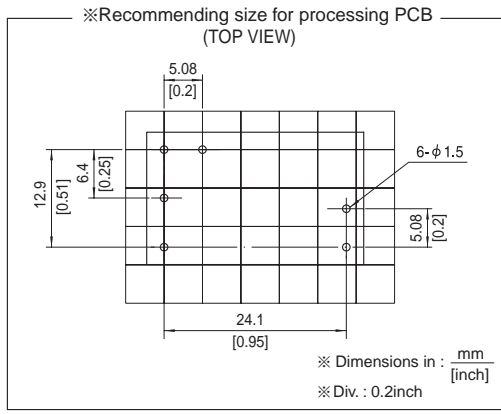
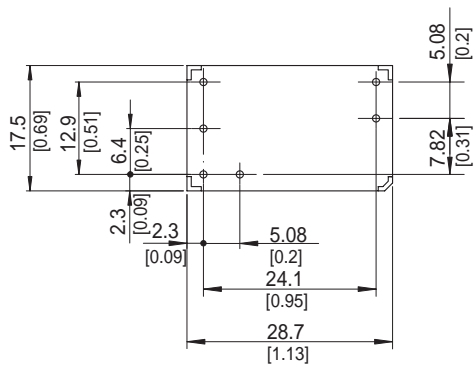
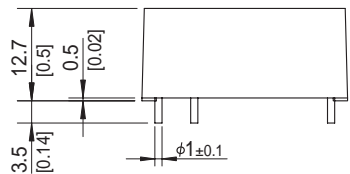

- ※ Tolerance : ±0.5 [±0.02]
- ※ Weight : 15g max
- ※ Case material : PBT
- ※ Pin material : Copper
- ※ Plating treatment of pin : Lead free plating
- ※ Dimensions in mm, []=inches

TUHS10

TUH S 10 F 05

① ② ③ ④ ⑤

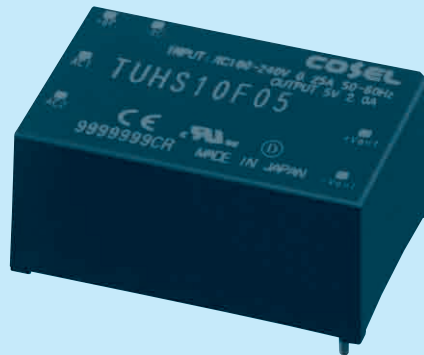

- ① Series name
- ② Single output
- ③ Output wattage
- ④ Universal Input
- ⑤ Output voltage

□ Class II

* Avoid short circuit between +BC and -BC. It may cause the failure of inside components.
 * To use TUHS, external components are required. Refer to the instruction manual for details.

| MODEL | TUHS10F05 | TUHS10F12 | TUHS10F24 |
|-----------------------|-----------|-----------|-----------|
| MAX OUTPUT WATTAGE[W] | 10.00 | 10.80 | 10.80 |
| DC OUTPUT | 5V 2A | 12V 0.9A | 24V 0.45A |

SPECIFICATIONS

| | MODEL | TUHS10F05 | TUHS10F12 | TUHS10F24 | |
|-------------------------------|---|---|-------------------|---------------|--------|
| INPUT | VOLTAGE[V] | AC85 - 264 1φ DC120 - 370 | | | |
| | CURRENT[A] | ACIN 100V | 0.25typ (Io=100%) | | |
| | | ACIN 200V | 0.14typ (Io=100%) | | |
| | FREQUENCY[Hz] | 50/60 (47 - 63) | | | |
| | EFFICIENCY[%] | ACIN 100V | 81typ | 85typ | 86typ |
| | | ACIN 200V | 82typ | 85typ | 87typ |
| INRUSH CURRENT | Limited by external components | | | | |
| LEAKAGE CURRENT[ma] | 0.40/0.75 max (ACIN100V/240V, 60Hz, Io=100%, According to IEC60950-1) | | | | |
| OUTPUT | VOLTAGE[V] | 5 | 12 | 24 | |
| | CURRENT[A] | 2 | 0.9 | 0.45 | |
| | LINE REGULATION[mV] | 20max | 48max | 96max | |
| | LOAD REGULATION[mV] | 40max | 100max | 150max | |
| | RIPPLE[mVp-p] | 30 to 100% Load *1 | 120max | 160max | 200max |
| | | 0 to 30% Load AC85V - 240V *1 | 400max | 480max | 580max |
| | RIPPLE NOISE[mVp-p] | 30 to 100% Load *1 | 160max | 200max | 240max |
| | | 0 to 30% Load AC85V - 240V *1 | 480max | 560max | 660max |
| | TEMPERATURE REGULATION[mV] | 0 to +70°C | 100max | 180max | 360max |
| | | -40 to +70°C | 150max | 270max | 480max |
| DRIFT[mV] | *2 | 20max | 48max | 96max | |
| OUTPUT VOLTAGE SETTING[V] | 4.90 - 5.30 | 11.40 - 12.60 | 23.00 - 25.00 | | |
| PROTECTION CIRCUIT AND OTHERS | OVERCURRENT PROTECTION | Works over 105% of rating and recover automatically | | | |
| | OVERVOLTAGE PROTECTION[V] | 5.50 - 8.00 | 13.20 - 19.20 | 26.40 - 38.40 | |
| ISOLATION | INPUT-OUTPUT | AC3,000V 1minute, Cutoff current = 10mA, DC500V 50MΩ min (20±15°C) | | | |
| ENVIRONMENT | OPERATING TEMP., HUMID. AND ALTITUDE | -40 to +85°C, 20 - 95%RH (Non condensing) (Refer to DERATING CURVE), 3,000m (10,000 feet) max | | | |
| | STORAGE TEMP., HUMID. AND ALTITUDE | -40 to +100°C, 20 - 95%RH (Non condensing), 9,000m (30,000 feet) max | | | |
| | VIBRATION | 10 - 55Hz, 49.0m/s ² (5G), 3minutes period, 60minutes each along X, Y and Z axis | | | |
| | IMPACT | 196.1m/s ² (20G), 11ms, once each along X, Y and Z axis | | | |
| SAFETY AND NOISE REGULATIONS | AGENCY APPROVALS | UL60950-1, C-UL (CSA60950-1), EN60950-1 | | | |
| | CONDUCTED NOISE | Complies with FCC-B, VCCI-B, CISPR-B, EN55022-B *3 | | | |
| | HARMONIC ATTENUATOR | Complies with IEC61000-3-2 (Class A) (Not built-in to active filter) | | | |
| OTHERS | CASE SIZE/WEIGHT | 33.0 × 15.0 × 22.0mm [1.3 × 0.59 × 0.86 inches] (W × H × D) / 25g max | | | |
| | COOLING METHOD | Convection / Forced air | | | |

*1 Refer to instruction manual for measuring method of electric characteristics.
 *2 Drift is the change in DC output for an eight hour period after a half-hour warm-up at 25°C, with the input voltage held constant at the rated value.
 *3 Do not ground secondly circuit, in case of a standard adapted.
 * Measured with 47μF capacitor as Cbc.

External view

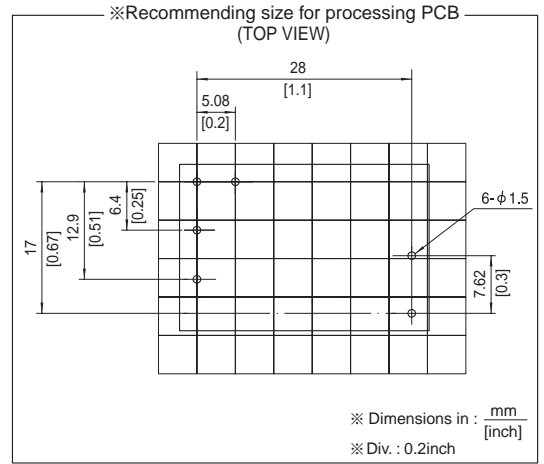
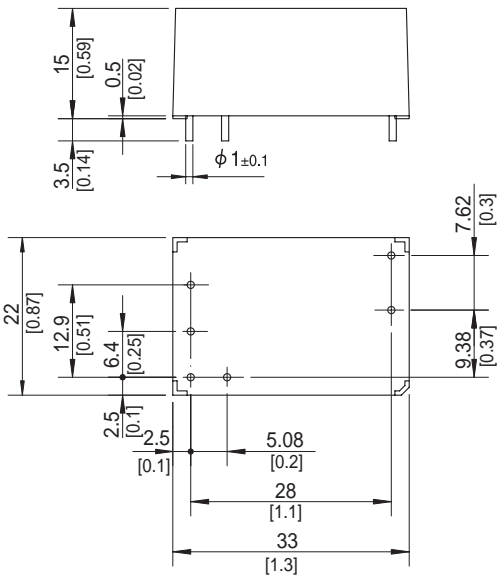

- ※ Tolerance : ± 0.5 [± 0.02]
- ※ Weight : 25g max
- ※ Case material : PBT
- ※ Pin material : Copper
- ※ Plating treatment of pin : Lead free plating
- ※ Dimensions in mm, []=inches

TUHS15

TUH S 15 F 12

① ② ③ ④ ⑤

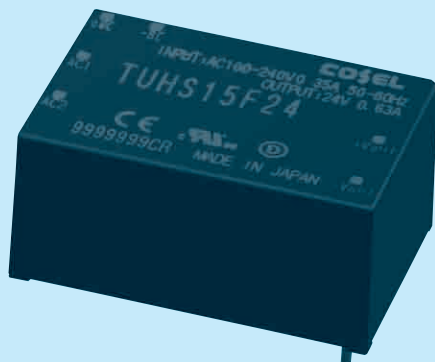

- ① Series name
- ② Single output
- ③ Output wattage
- ④ Universal Input
- ⑤ Output voltage

□ Class II

* Avoid short circuit between +BC and -BC. It may cause the failure of inside components.
 * To use TUHS, external components are required. Refer to the instruction manual for details.

| | | |
|-----------------------|-----------|-----------|
| MODEL | TUHS15F12 | TUHS15F24 |
| MAX OUTPUT WATTAGE[W] | 15.00 | 15.12 |
| DC OUTPUT | 12V 1.25A | 24V 0.63A |

SPECIFICATIONS

| | MODEL | TUHS15F12 | TUHS15F24 | |
|-------------------------------|---|---|-------------------|--------|
| INPUT | VOLTAGE[V] | AC85 - 264 1 φ DC120 - 370 | | |
| | CURRENT[A] | ACIN 100V | 0.35typ (Io=100%) | |
| | | ACIN 200V | 0.18typ (Io=100%) | |
| | FREQUENCY[Hz] | 50/60 (47 - 63) | | |
| | EFFICIENCY[%] | ACIN 100V | 85typ | 86typ |
| | | ACIN 200V | 85typ | 87typ |
| INRUSH CURRENT | Limited by external components | | | |
| LEAKAGE CURRENT[ma] | 0.40/0.75 max (ACIN100V/240V , 60Hz, Io=100% , According to IEC60950-1) | | | |
| OUTPUT | VOLTAGE[V] | 12 | 24 | |
| | CURRENT[A] | 1.25 | 0.63 | |
| | LINE REGULATION[mV] | 48max | 96max | |
| | LOAD REGULATION[mV] | 100max | 150max | |
| | RIPPLE[mVp-p] | 30 to 100% Load *1 | 160max | 200max |
| | | 0 to 30% Load AC85V - 240V *1 | 480max | 580max |
| | RIPPLE NOISE[mVp-p] | 30 to 100% Load *1 | 200max | 240max |
| | | 0 to 30% Load AC85V - 240V *1 | 560max | 660max |
| | TEMPERATURE REGULATION[mV] | 0 to +50°C | 180max | 360max |
| | | -40 to +50°C | 270max | 480max |
| DRIFT[mV] | *2 | 48max | 96max | |
| OUTPUT VOLTAGE SETTING[V] | 11.40 - 12.60 | 23.00 - 25.00 | | |
| PROTECTION CIRCUIT AND OTHERS | OVERCURRENT PROTECTION | Works over 105% of rating and recover automatically | | |
| | OVERVOLTAGE PROTECTION[V] | 13.20 - 19.20 | 26.40 - 38.40 | |
| ISOLATION | INPUT-OUTPUT | AC3,000V 1minute, Cutoff current = 10mA, DC500V 50MΩ min (20±15°C) | | |
| ENVIRONMENT | OPERATING TEMP., HUMID. AND ALTITUDE | -40 to +85°C , 20 - 95%RH (Non condensing) (Refer to DERATING CURVE) , 3,000m (10,000 feet) max | | |
| | STORAGE TEMP., HUMID. AND ALTITUDE | -40 to +100°C , 20 - 95%RH (Non condensing) , 9,000m (30,000 feet) max | | |
| | VIBRATION | 10 - 55Hz, 49.0m/s ² (5G), 3minutes period, 60minutes each along X, Y and Z axis | | |
| | IMPACT | 196.1m/s ² (20G), 11ms, once each along X, Y and Z axis | | |
| SAFETY AND NOISE REGULATIONS | AGENCY APPROVALS | UL60950-1, C-UL (CSA60950-1), EN60950-1 | | |
| | CONDUCTED NOISE | Complies with FCC-B, VCCI-B, CISPR-B, EN55022-B *3 | | |
| | HARMONIC ATTENUATOR | Complies with IEC61000-3-2 (Class A) (Not built-in to active filter) | | |
| OTHERS | CASE SIZE/WEIGHT | 33.0 × 15.0 × 22.0mm [1.3 × 0.59 × 0.86 inches] (W × H × D) / 25g max | | |
| | COOLING METHOD | Convection / Forced air | | |

*1 Refer to instruction manual for measuring method of electric characteristics.
 *2 Drift is the change in DC output for an eight hour period after a half-hour warm-up at 25°C, with the input voltage held constant at the rated value.
 *3 Do not ground secondly circuit, in case of a standard adapted.
 * Measured with 68μF capacitor as Cbc.

External view

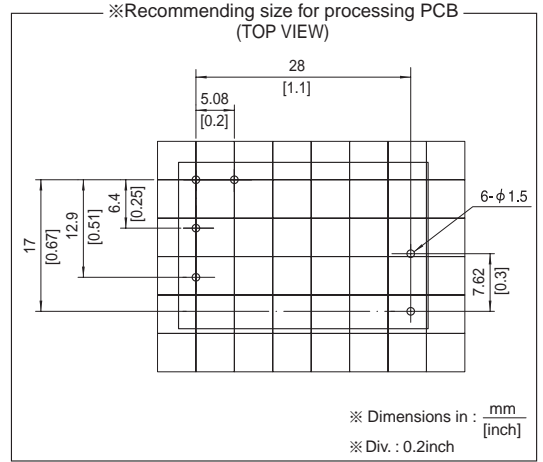
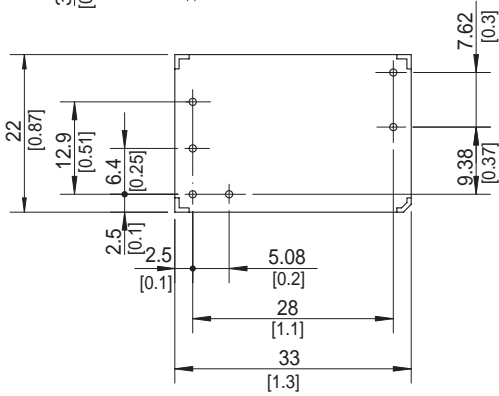
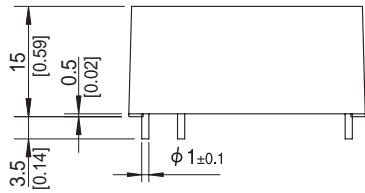

- ※ Dimensions in : $\frac{\text{mm}}{[\text{inch}]}$
- ※ Div. : 0.2inch
- ※ Tolerance : ± 0.5 [± 0.02]
- ※ Weight : 25g max
- ※ Case material : PBT
- ※ Pin material : Copper
- ※ Plating treatment of pin : Lead free plating
- ※ Dimensions in mm, []=inches

TUHS25

TUH S 25 F 05

① ② ③ ④ ⑤

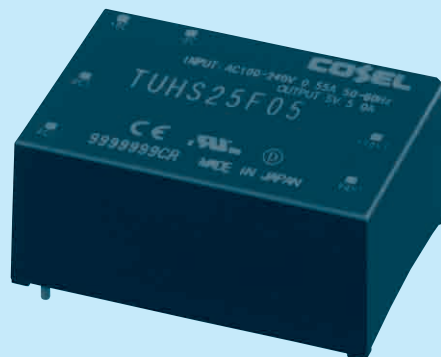

- ① Series name
- ② Single output
- ③ Output wattage
- ④ Universal Input
- ⑤ Output voltage

□ Class II

* Avoid short circuit between +BC and -BC. It may cause the failure of inside components.
 * To use TUHS, external components are required. Refer to the instruction manual for details.

| MODEL | TUHS25F05 | TUHS25F12 | TUHS25F24 |
|-----------------------|-----------|-----------|-----------|
| MAX OUTPUT WATTAGE[W] | 25.00 | 25.20 | 26.40 |
| DC OUTPUT | 5V 5A | 12V 2.1A | 24V 1.1A |

SPECIFICATIONS

| | MODEL | TUHS25F05 | TUHS25F12 | TUHS25F24 | |
|-------------------------------|---|---|-------------------|---------------|--------|
| INPUT | VOLTAGE[V] | AC85 - 264 1 φ DC120 - 370 | | | |
| | CURRENT[A] | ACIN 100V | 0.55typ (Io=100%) | | |
| | | ACIN 200V | 0.35typ (Io=100%) | | |
| | FREQUENCY[Hz] | 50/60 (47 - 63) | | | |
| | EFFICIENCY[%] | ACIN 100V | 87typ | 88typ | 89typ |
| | | ACIN 200V | 87typ | 88typ | 90typ |
| INRUSH CURRENT | Limited by external components | | | | |
| LEAKAGE CURRENT[ma] | 0.40/0.75 max (ACIN100V/240V , 60Hz, Io=100% , According to IEC60950-1) | | | | |
| OUTPUT | VOLTAGE[V] | 5 | 12 | 24 | |
| | CURRENT[A] | 5 | 2.1 | 1.1 | |
| | LINE REGULATION[mV] | 20max | 48max | 96max | |
| | LOAD REGULATION[mV] | 40max | 100max | 150max | |
| | RIPPLE[mVp-p] | 30 to 100% Load *1 | 120max | 160max | 200max |
| | | 0 to 30% Load AC85V - 240V *1 | 400max | 480max | 580max |
| | RIPPLE NOISE[mVp-p] | 30 to 100% Load *1 | 160max | 200max | 240max |
| | | 0 to 30% Load AC85V - 240V *1 | 480max | 560max | 660max |
| | TEMPERATURE REGULATION[mV] | 0 to +50°C | 100max | 180max | 360max |
| | | -40 to +50°C | 150max | 270max | 480max |
| DRIFT[mV] | *2 | 20max | 48max | 96max | |
| OUTPUT VOLTAGE SETTING[V] | 4.90 - 5.30 | 11.40 - 12.60 | 23.00 - 25.00 | | |
| PROTECTION CIRCUIT AND OTHERS | OVERCURRENT PROTECTION | Works over 105% of rating and recover automatically | | | |
| | OVERVOLTAGE PROTECTION[V] | 5.50 - 8.00 | 13.20 - 19.20 | 26.40 - 38.40 | |
| ISOLATION | INPUT-OUTPUT | AC3,000V 1minute, Cutoff current = 10mA, DC500V 50MΩ min (20±15°C) | | | |
| ENVIRONMENT | OPERATING TEMP., HUMID. AND ALTITUDE | -40 to +85°C, 20 - 95%RH (Non condensing) (Refer to DERATING CURVE), 3,000m (10,000 feet) max | | | |
| | STORAGE TEMP., HUMID. AND ALTITUDE | -40 to +100°C, 20 - 95%RH (Non condensing), 9,000m (30,000 feet) max | | | |
| | VIBRATION | 10 - 55Hz, 49.0m/s ² (5G), 3minutes period, 60minutes each along X, Y and Z axis | | | |
| | IMPACT | 196.1m/s ² (20G), 11ms, once each along X, Y and Z axis | | | |
| SAFETY AND NOISE REGULATIONS | AGENCY APPROVALS | UL60950-1, C-UL (CSA60950-1), EN60950-1 | | | |
| | CONDUCTED NOISE | Complies with FCC-B, VCCI-B, CISPR-B, EN55022-B *3 | | | |
| | HARMONIC ATTENUATOR | Complies with IEC61000-3-2 (Class A) (Not built-in to active filter) | | | |
| OTHERS | CASE SIZE/WEIGHT | 36.0 X 16.5 X 25.4mm [1.42 X 0.65 X 1.0 inches] (W X H X D) / 40g max | | | |
| | COOLING METHOD | Convection / Forced air | | | |

*1 Refer to instruction manual for measuring method of electric characteristics.
 *2 Drift is the change in DC output for an eight hour period after a half-hour warm-up at 25°C, with the input voltage held constant at the rated value.
 *3 Do not ground secondly circuit, in case of a standard adapted.
 * Measured with 120μF capacitor as Cbc.

External view

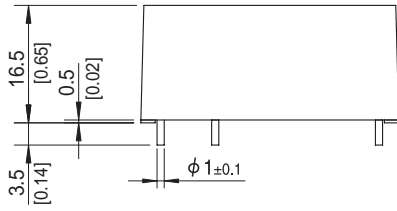

- ※ Tolerance : ± 0.5 [± 0.02]
- ※ Weight : 40g max
- ※ Case material : PBT
- ※ Pin material : Copper
- ※ Plating treatment of pin : Lead free plating
- ※ Dimensions in mm, []=inches

Mouser Electronics

Authorized Distributor

Click to View Pricing, Inventory, Delivery & Lifecycle Information:

Cosel:

[TUHS3F24](#) [TUHS5F24](#) [TUHS3F12](#) [TUHS25F24](#) [TUHS5F12](#) [TUHS10F24](#) [TUHS10F12](#) [TUHS10F05](#) [TUHS5F05](#)
[TUHS3F05](#) [TUHS25F12](#) [TUHS25F05](#) [TUHS15F24](#) [TUHS15F12](#)

Компания «Life Electronics» занимается поставками электронных компонентов импортного и отечественного производства от производителей и со складов крупных дистрибьюторов Европы, Америки и Азии.

С конца 2013 года компания активно расширяет линейку поставок компонентов по направлению коаксиальный кабель, кварцевые генераторы и конденсаторы (керамические, пленочные, электролитические), за счёт заключения дистрибьюторских договоров

Мы предлагаем:

- Конкурентоспособные цены и скидки постоянным клиентам.
- Специальные условия для постоянных клиентов.
- Подбор аналогов.
- Поставку компонентов в любых объемах, удовлетворяющих вашим потребностям.
- Приемлемые сроки поставки, возможна ускоренная поставка.
- Доставку товара в любую точку России и стран СНГ.
- Комплексную поставку.
- Работу по проектам и поставку образцов.
- Формирование склада под заказчика.
- Сертификаты соответствия на поставляемую продукцию (по желанию клиента).
- Тестирование поставляемой продукции.
- Поставку компонентов, требующих военную и космическую приемку.
- Входной контроль качества.
- Наличие сертификата ISO.

В составе нашей компании организован Конструкторский отдел, призванный помогать разработчикам, и инженерам.

Конструкторский отдел помогает осуществить:

- Регистрацию проекта у производителя компонентов.
- Техническую поддержку проекта.
- Защиту от снятия компонента с производства.
- Оценку стоимости проекта по компонентам.
- Изготовление тестовой платы монтаж и пусконаладочные работы.



Тел: +7 (812) 336 43 04 (многоканальный)

Email: org@lifeelectronics.ru