

ScopeMeter® Test Tool 190 Series II

Fluke 190-062, -102, -104, -202, -204, -502, -504

Users Manual

May 2011, Rev.2, 1/14

© 2011-2014 Fluke Corporation. All rights reserved. Specifications are subject to change without notice.

All product names are trademarks of their respective companies.

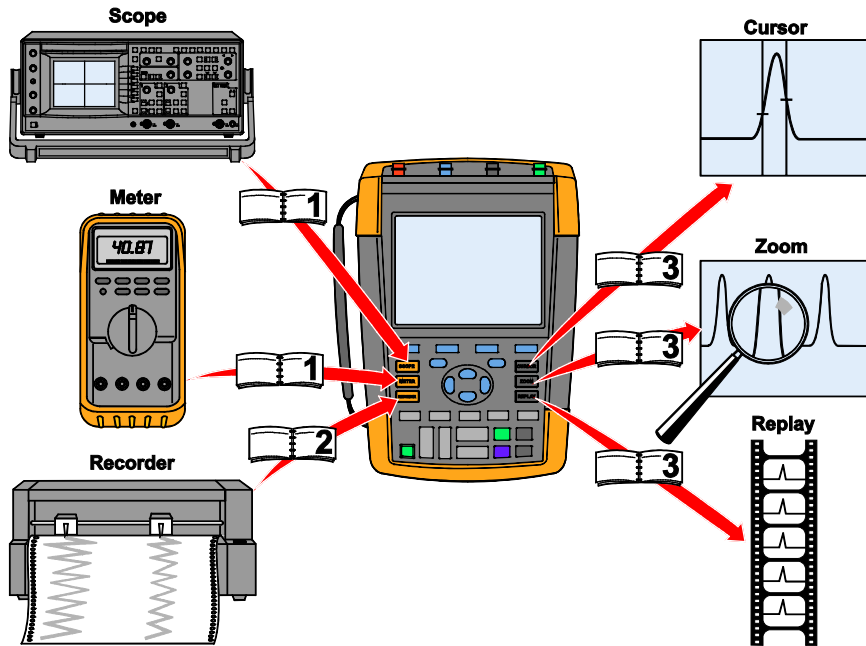

LIMITED WARRANTY & LIMITATION OF LIABILITY

Each Fluke product is warranted to be free from defects in material and workmanship under normal use and service. The warranty period is three years for the test tool and one year for its accessories. The warranty period begins on the date of shipment. Parts, product repairs and services are warranted for 90 days. This warranty extends only to the original buyer or end-user customer of a Fluke authorized reseller, and does not apply to fuses, disposable batteries or to any product which, in Fluke's opinion, has been misused, altered, neglected or damaged by accident or abnormal conditions of operation or handling. Fluke warrants that software will operate substantially in accordance with its functional specifications for 90 days and that it has been properly recorded on non-defective media. Fluke does not warrant that software will be error free or operate without interruption.

Fluke authorized resellers shall extend this warranty on new and unused products to end-user customers only but have no authority to extend a greater or different warranty on behalf of Fluke. Warranty support is available if product is purchased through a Fluke authorized sales outlet or Buyer has paid the applicable international price. Fluke reserves the right to invoice Buyer for importation costs of repair/replacement parts when product purchased in one country is submitted for repair in another country.

Fluke's warranty obligation is limited, at Fluke's option, to refund of the purchase price, free of charge repair, or replacement of a defective product which is returned to a Fluke authorized service center within the warranty period.

To obtain warranty service, contact your nearest Fluke authorized service center or send the product, with a description of the difficulty, postage and insurance prepaid (FOB Destination), to the nearest Fluke authorized service center. Fluke assumes no risk for damage in transit. Following warranty repair, the product will be returned to Buyer, transportation prepaid (FOB Destination). If Fluke determines that the failure was caused by misuse, alteration, accident or abnormal condition of operation or handling, Fluke will provide an estimate of repair costs and obtain authorization before commencing the work. Following repair, the product will be returned to the Buyer transportation prepaid and the Buyer will be billed for the repair and return transportation charges (FOB Shipping Point).

THIS WARRANTY IS BUYER'S SOLE AND EXCLUSIVE REMEDY AND IS IN LIEU OF ALL OTHER WARRANTIES, EXPRESS OR IMPLIED, INCLUDING BUT NOT LIMITED TO ANY IMPLIED WARRANTY OF MERCHANTABILITY OR FITNESS FOR A PARTICULAR PURPOSE. FLUKE SHALL NOT BE LIABLE FOR ANY SPECIAL, INDIRECT, INCIDENTAL OR CONSEQUENTIAL DAMAGES OR LOSSES, INCLUDING LOSS OF DATA, WHETHER ARISING FROM BREACH OF WARRANTY OR BASED ON CONTRACT, TORT, RELIANCE OR ANY OTHER THEORY.

Since some countries or states do not allow limitation of the term of an implied warranty, or exclusion or limitation of incidental or consequential damages, the limitations and exclusions of this warranty may not apply to every buyer. If any provision of this Warranty is held invalid or unenforceable by a court of competent jurisdiction, such holding will not affect the validity or enforceability of any other provision.

Fluke Corporation, P.O. Box 9090, Everett, WA 98206-9090 USA, or

Fluke Industrial B.V., P.O. Box 90, 7600 AB, Almelo, The Netherlands

SERVICE CENTERS

To locate an authorized service center, visit us on the World Wide Web:

<http://www.fluke.com>

or call Fluke using any of the phone numbers listed below:

+1-888-993-5853 in U.S.A. and Canada

+31-40-2675200 in Europe

+1-425-446-5500 from other countries

Table of Contents

Chapter	Title	Page
Chapter 1		1-11
1	Using the Scope and Meter	1-11
	Powering the Test Tool	1-11
	Resetting the Test Tool	1-12
	Navigating a Menu	1-13
	Hiding Key Labels and Menus.....	1-14
	Key Illumination	1-15
	Input Connections	1-15
	Making Input Connections.....	1-16
	Adjusting the Probe Type Settings	1-18
	Selecting an Input Channel	1-18
	Displaying an Unknown Signal with Connect-and-View™.....	1-19
	Making Automatic Scope Measurements.....	1-20
	Freezing the Screen	1-22
	Using Average, Persistence and Glitch Capture	1-23



	Using Average for Smoothing Waveforms	1-23
	Smart average	1-23
	Using Persistence, Envelope and Dot-Join to Display Waveforms	1-24
	Displaying Glitches	1-25
	Suppressing High Frequency Noise.....	1-26
	Acquiring Waveforms.....	1-27
	Setting the Acquisition Speed and Waveform Memory Depth	1-27
	Selecting AC-Coupling.....	1-27
	Reversing the Polarity of the Displayed Waveform	1-28
	Variable Input Sensitivity.....	1-28
	Working with Noisy Waveforms	1-29
	Using Mathematics Functions +, -, x, XY-mode	1-30
	Using Mathematics Function Spectrum (FFT).....	1-31
	Comparing Waveforms	1-33
	Pass - Fail Testing	1-35
	Analyzing Waveforms	1-35
	Making Automatic Meter Measurements (for models 190-xx4).....	1-36
	Selecting a Meter Measurement	1-36
	Making Relative Meter Measurements.....	1-37
	Making Multimeter Measurements (for models 190-xx2)	1-39
	Making Meter Connections	1-39
	Measuring Resistance Values	1-39
	Making a Current Measurement.....	1-40
	Selecting Auto/Manual Ranges.....	1-42
	Making Relative Meter Measurements.....	1-43
2	Using The Recorder Functions.....	2-41
	Opening the Recorder Main Menu.....	2-41
	Plotting Measurements Over Time (TrendPlot™).....	2-42
	Starting a TrendPlot Function	2-42

	Displaying Recorded Data	2-44
	Changing the Recorder Options	2-44
	Turning Off the TrendPlot Display	2-44
	Recording Scope Waveforms In Deep Memory (Scope Record)	2-45
	Starting a Scope Record Function	2-45
	Displaying Recorded Data	2-46
	Using Scope Record in Single Sweep Mode	2-46
	Using Triggering to Start or Stop Scope Record	2-47
	Analyzing a TrendPlot or Scope Record	2-48
3	Using Replay, Zoom and Cursors	3-49
	Replaying the 100 Most Recent Scope Screens	3-49
	Replaying Step-by-Step	3-50
	Replaying Continuously	3-51
	Turning Off the Replay Function	3-51
	Capturing 100 Intermittents Automatically	3-51
	Zooming in on a Waveform	3-52
	Turning Off the Zoom Function	3-52
	Making Cursor Measurements	3-53
	Using Horizontal Cursors on a Waveform	3-53
	Using Vertical Cursors on a Waveform	3-54
	Using Cursors on a Mathematical Result (+ - x) Waveform	3-55
	Using Cursors on Spectrum Measurements	3-55
	Making Rise Time Measurements	3-56
4	Triggering on Waveforms	4-57
	Setting Trigger Level and Slope	4-58
	Using Trigger Delay or Pre-trigger	4-59
	Automatic Trigger Options	4-60
	Triggering on Edges	4-61

	Triggering on Noisy Waveforms.....	4-62
	Making a Single Acquisition	4-62
	N-Cycle Triggering	4-63
	Triggering on External Waveforms (models 190-xx2).....	4-64
	Triggering on Video Signals.....	4-65
	Triggering on Video Frames	4-66
	Triggering on Video Lines	4-66
	Triggering on Pulses.....	4-67
	Detecting Narrow Pulses	4-67
	Finding Missing Pulses	4-68
5	Using Memory and PC.....	5-71
	Using the USB Ports.....	5-71
	Saving and Recalling.....	5-72
	Saving Screens with Associated Setups.....	5-74
	Saving Screens in .bmp Format (Print Screen).....	5-77
	Deleting Screens with Associated Setups.....	5-78
	Recalling Screens with Associated Setups	5-79
	Recalling a Setup Configuration.....	5-80
	Viewing Stored Screens.....	5-81
	Renaming Stored Screens and Setup Files	5-81
	Copying-Moving Stored Screens and Setup Files.....	5-82
	Using FlukeView®	5-83
	Connecting to a Computer	5-83
	Using the Standard Accessories.....	6-81
	Using the Independently Floating Isolated Inputs	6-83
	Measuring Using Independently Floating Isolated Inputs.....	6-83
	Using the Tilt Stand	6-86
	Kensington®-lock	6-87
	Fixing the Hangstrap.....	6-87

	Resetting the Test Tool	6-88
	Suppressing Key Labels and Menu's	6-88
	Changing the Information Language	6-89
	Adjusting the Contrast and Brightness	6-89
	Changing Date and Time	6-90
	Saving Battery Life	6-91
	Setting the Power Down Timer	6-91
	Setting the Display AUTO-off Timer	6-92
	Changing the Auto Set Options	6-93
7	Maintaining the Test Tool	7-95
	Cleaning the Test Tool	7-95
	Storing the Test Tool	7-95
	Charging the Batteries	7-96
	Replacing the Battery Pack	7-97
	Calibrating the Voltage Probes	7-99
	Displaying Version and Calibration Information	7-101
	Displaying Battery Information	7-101
	Parts and Accessories	7-102
	Replacement Parts	7-102
	Optional Accessories	7-105
	Troubleshooting	7-108
	The Test Tool Shuts Down After a Short Time	7-108
	The Screen Remains Black	7-108
	The Test Tool Cannot Be Turned Off	7-108
	FlukeView [®] Does Not Recognize The Test Tool	7-108
	Battery Operated Fluke Accessories Do Not Function	7-109
8	Specifications	8-111
	Introduction	8-111

Oscilloscope	8-112
Isolated Inputs A,B, C and D (Vertical)	8-112
Horizontal.....	8-112
Trigger and Delay	8-114
Automatic Connect-and-View Trigger	8-114
Edge Trigger	8-114
Isolated External Trigger (190-xx2).....	8-114
Video Trigger	8-115
Pulse Width Trigger	8-115
Continuous Auto Set.....	8-115
Automatic Capturing Scope Screens	8-115
Automatic Scope Measurements	8-116
General	8-116
DC Voltage (VDC).....	8-116
AC Voltage (VAC).....	8-116
AC+DC Voltage (True RMS).....	8-117
Amperes (AMP)	8-118
Peak.....	8-118
Frequency (Hz).....	8-118
Duty Cycle (DUTY)	8-118
Pulse Width (PULSE).....	8-118
Vpwm.....	8-118
V/Hz	8-119
Power (A and B, C and D)	8-119
Phase (A and B, C and D)	8-119
Temperature (TEMP)	8-119
Decibel (dB)	8-119
Meter Measurements for Fluke 190-xx4	8-120
Meter Measurements for Fluke 190-xx2	8-120

Meter Input (Banana Jacks)	8-120
Meter Functions	8-120
General	8-120
Ohms (Ω)	8-121
Continuity (CONT)	8-121
Diode	8-121
Temperature (TEMP)	8-121
DC Voltage (VDC)	8-121
AC Voltage (VAC)	8-121
AC+DC Voltage (True RMS)	8-122
Amperes (AMP)	8-122
Recorder	8-122
TrendPlot (Meter or Scope)	8-122
Scope Record	8-122
Zoom, Replay and Cursors	8-123
Zoom	8-123
Replay	8-123
Cursor Measurements	8-123
Miscellaneous	8-124
Display	8-124
 Power	8-124
Probe Calibration	8-124
Internal Memory	8-125
External Memory	8-125
Mechanical	8-125
Interface Ports	8-125
Environmental	8-126
Certifications	8-126
 Safety	8-127

ScopeMeter® Test Tool 190 Series II

Users Manual



10:1 Probe VPS410	8-129
Accuracy	8-129
Electromagnetic Immunity	8-130

Introduction

Warning

Read “Safety Information” before using this instrument.

The descriptions and instructions in this manual apply to all ScopeMeter® Test Tool 190 Series II versions (hereafter referred to as the instrument or as the test tool). The versions are listed below. The version 190-x04 appears in most illustrations.

Input C and Input D, and the Input C and Input D selection keys ( and ) are only present on the versions 190-x04.

Version	Description
190-062	Two 60 MHz Scope Inputs (BNC), One Meter Input (banana jacks).
190-102	Two 100 MHz Scope Inputs (BNC), One Meter Input (banana jacks).
190-104	Four 100 MHz Scope Inputs (BNC)
190-202	Two 200 MHz Scope Inputs (BNC), One Meter Input (banana jacks).
190-204	Four 200 MHz Scope Inputs (BNC).
190-502	Two 500 MHz Scope Inputs (BNC), One Meter Input (banana jacks).
190-504	Four 500 MHz Scope Inputs (BNC).

Unpacking the Test Tool Kit

The items in Figure 1 are included in your test tool kit:

Note

When new, the rechargeable Li-ion battery is not fully charged. See Chapter 7.

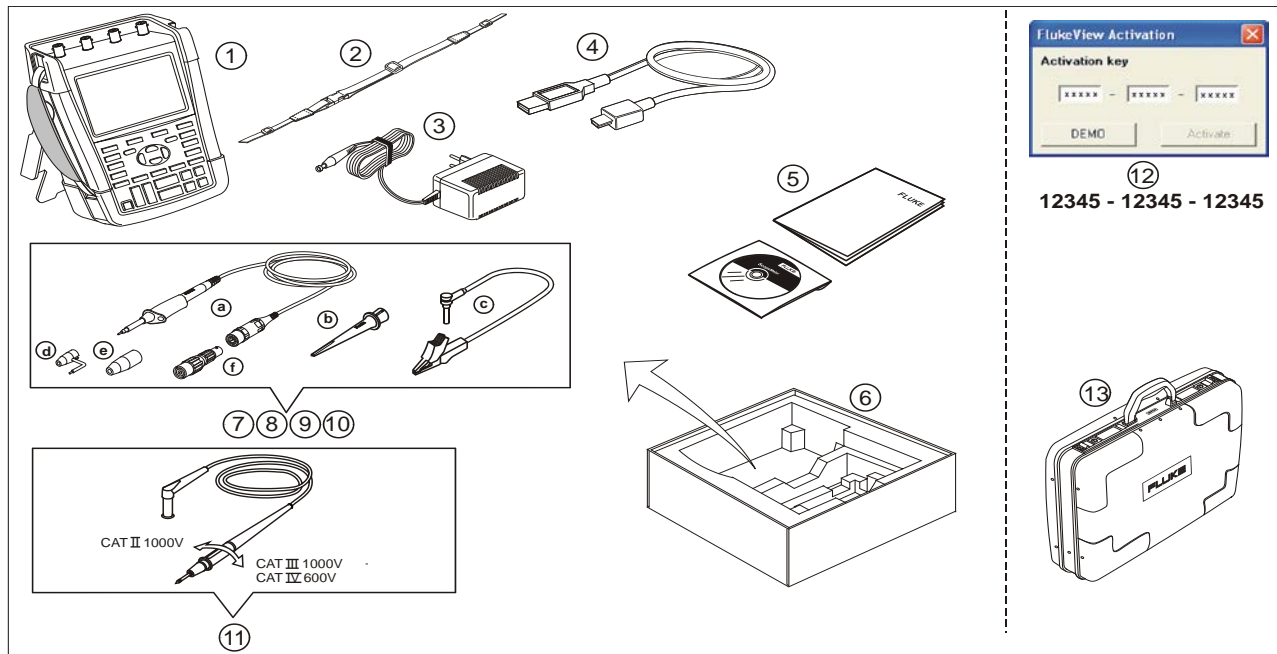

Figure 1. Test Tool Kit

All Fluke 190 Series II versions include the following items:

#	Description
1	Test Tool including <ul style="list-style-type: none"> – side strap – battery pack BP290 (models 190-xx2) or BP291 (models 190-xx4 and 190-5xx)
2	Hang Strap (see Chapter 6 for mounting instructions)
3	Power Adapter (country dependent, may vary from what is shown in Figure 1)
4	USB interface cable for PC connection (USB-A to mini-USB-B)
5	Safety Information sheet + CD ROM with Users Manual (multi-language) and FlukeView® ScopeMeter® Software for Windows demo package (with restricted functionality)
6	Shipment box (basic version only)

#	Description
7	Voltage Probe Set (red)
8	Voltage Probe Set (blue)
9	Voltage Probe Set (gray), <i>not for 190-xx2</i>
10	Voltage Probe Set (green), <i>not for 190-xx2</i> <i>Each set includes:</i> <ul style="list-style-type: none"> a) Fluke 190-50x: 10:1 Voltage Probe, 500 MHz (red or blue or gray or green) Other models: 10:1 Voltage Probe, 300 MHz (red or blue or gray or green) b) Hook Clip for Probe Tip (black) c) Ground Lead with Mini Alligator Clip (black) d) Ground Spring for Probe Tip (black) e) Insulation Sleeve (black) f) Fluke 190-50x: 50 Ohm (1 W) Terminator
11	Test Leads with test pins (one red, one black), for models 190-xx2 only.

Fluke 190-xxx /S versions include also the following items (SCC290 kit):

#	Description
12	FlukeView® ScopeMeter® Software for Windows activation key (converts FlukeView® DEMO status into full operational status).
13	Hard Shell Carrying Case

Safety Information: Read First











Read all safety information before you use the product.

Specific warning and caution statements, where they apply, appear throughout the manual.

A “Warning” identifies conditions and actions that pose hazard(s) to the user.

A “Caution” identifies conditions and actions that may damage the product.

The following international symbols are used on the product and in this manual.

	Risk of Danger. Important information. See Manual.
	Double Insulated
	Conforms to relevant North American Safety Standards.
	Conforms to relevant Australian standards.
	Conforms to relevant South Korean EMC Standards.
	Battery Safety Approval
	Earth Ground
	Recycling information.
	Conforms to European Union directives
	DC (Direct Current)
	AC or DC (Alternating or Direct Current)

	This product complies with the WEEE Directive (2002/96/EC) marking requirements. The affixed label indicates that you must not discard this electrical/electronic product in domestic household waste. Product Category: With reference to the equipment types in the WEEE Directive Annex I, this product is classed as category 9 "Monitoring and Control Instrumentation" product. Do not dispose of this product as unsorted municipal waste. Go to Fluke's website for recycling information.
CAT III	Measurement Category III is applicable to test and measuring circuits connected to the distribution part of the building's low-voltage MAINS installation.
CAT IV	Measurement Category IV is applicable to test and measuring circuits connected at the source of the building's low-voltage MAINS installation.

 **Warning**

To avoid electrical shock or fire:

- Use only the Fluke power supply, Model BC190 (Power Adapter).
- Before use, check that the selected/indicated range on the BC190 matches the local line power voltage and frequency.
- For the BC190/808 and BC190/820 universal Power Adapters only use line cords that comply with the local safety regulations.

Note:

To accommodate connection to various line power sockets, the BC190/808 and BC190/820 universal Power Adapters are equipped with a male plug that must be connected to a line cord appropriate for local use. Since the adapter is isolated, the line cord does not need to be equipped with a terminal for connection to protective ground. Since line cords with a protective grounding terminal are more commonly available you might consider using these anyhow.

 **Warning**

To avoid electrical shock or fire if a product input is connected to more than 42 V peak (30 Vrms) or 60 V dc:

- Use only insulated voltage probes, test leads and adapters supplied with the product, or indicated by Fluke as suitable for the Fluke 190 Series II ScopeMeter® Test Tool series.
- Before use, inspect voltage probes, test leads and accessories for mechanical damage and replace when damaged.
- Remove all probes, test leads and accessories that are not in use.
- Always connect the power adapter first to the ac outlet before connecting it to the product.
- Do not touch voltages >30 V ac rms, 42 V ac peak, or 60 V dc.
- Do not connect the ground spring (figure 1, item d) to voltages higher than 42 V peak (30 Vrms) from earth ground.
- When using the ground reference lead with any of the probes, make sure that the black isolation sleeve (Figure 1, item. 10e) is over the probe tip.

- Do not apply more than the rated voltage, between the terminals or between each terminal and earth ground.
- Do not apply input voltages above the rating of the instrument. Use caution when using 1:1 test leads because the probe tip voltage will be directly transmitted to the product.
- Do not use exposed metal BNC or banana plug connectors. Fluke offers cables with plastic, safety designed BNC connectors suitable for the ScopeMeter® Test Tool product, see Chapter 7 'Optional accessories'.
- Do not insert metal objects into connectors.
- Use the product only as specified, or the protection supplied by the product can be compromised.
- Carefully read all instructions.
- Do not use the product if it operates incorrectly.
- Do not use the product or its accessories in case of any damage.
- Disable the product or its accessories in case of any damage.
- Keep fingers behind the finger guards on the probes.
- Use only correct measurement category (CAT), voltage, and current rated probes, test leads, and adapters for the measurement.
- Do not exceed the Measurement Category (CAT) rating of the lowest rated individual component of a product, probe, or accessory.
- Do not use the product around explosive gas, vapor, or in damp or wet environments.
- Measure a known voltage first to make sure that the product operates correctly.
- Examine the case before you use the product. Look for cracks or missing plastic. Carefully look at the insulation around the terminals.
- Do not work alone.
- Comply with local and national safety codes. Use personal protective equipment (approved rubber gloves, face protection, and flame resistant clothes) to prevent shock and arc blast injury where hazardous live conductors are exposed.
- The battery door must be closed and locked before you operate the product.

- **Do not operate the product with covers removed or the case open. Hazardous voltage exposure is possible.**
- **Remove the input signals before you clean the product.**
- **Use only specified replacement parts.**

Voltage ratings that are mentioned in the warnings are given as limits for “working voltage”. They represent V ac rms (50-60 Hz) for ac sinewave applications and as V dc for dc applications.

Measurement Category IV refers to the overhead or underground utility service of an installation.

Measurement Category III refers to distribution level and fixed installation circuits inside a building.

Measurement Category II refers to local level, which is applicable for appliances and portable equipment.

The terms ‘Isolated’ or ‘Electrically floating’ are used in this manual to indicate a measurement in which the product input BNC is connected to a voltage different from earth ground.

The isolated input connectors have no exposed metal and are fully insulated to protect against electrical shock.

The BNC jacks can independently be connected to a voltage above earth ground for isolated (electrically floating) measurements and are rated up to 1000 Vrms CAT III and 600 Vrms CAT IV above earth ground.

If Safety Features are Impaired

Use of the product in a manner not specified may impair the protection provided by the equipment.

Do not use test leads if they are damaged. Examine the test leads for damaged insulation, exposed metal, or if the wear indicator shows.

Whenever it is likely that safety has been impaired, the product must be turned off and disconnected from the line power. The matter should then be referred to qualified personnel. Safety is likely to be impaired if, for example, the product fails to perform the intended measurements or shows visible damage.

Safe Use of Li-ion battery pack

The battery pack Fluke model BP290 (26 Wh)/BP291 (52 Wh) has been tested in accordance with the UN Manual of Tests and Criteria Part III Subsection 38.3 (ST/SG/AC.10/11/Rev.3) – more commonly known as the UN T1..T8 – tests, and have been found to comply with the stated criteria. The battery pack has been tested acc.

to EN/IEC62133. As a result they can be shipped unrestricted internationally by any means.

Recommendations to safe storage of battery pack.

- Do not store battery packs near heat or fire. Do not store in sunlight.
- Do not remove a battery pack from its original packaging until required for use.
- When possible, remove the battery pack from the equipment when not in use.
- Fully charge the battery pack before storing it for an extended period to avoid a defect.
- After extended periods of storage, it may be necessary to charge and discharge the battery packs several times to obtain maximum performance.
- Keep the battery pack out of the reach of children and animals.
- Seek medical advise if a battery or part of it has been swallowed.

Recommendations to safe use of the battery pack.

- The battery pack needs to be charged before use. Use only Fluke approved power adapters to charge the battery pack. Refer to Fluke's safety instructions and Users Manual for proper charging instructions.
- Do not leave a battery on prolonged charge when not in use.

- The battery pack gives the best performance when operated at normal room temperature $20\text{ }^{\circ}\text{C} \pm 5\text{ }^{\circ}\text{C}$ ($68\text{ }^{\circ}\text{F} \pm 9\text{ }^{\circ}\text{F}$).
- Do not put battery packs near heat or fire. Do not put in sunlight.
- Do not subject battery packs to severe impacts such as mechanical shock.
- Keep the battery pack clean and dry. Clean dirty connectors with a dry, clean cloth
- Do not use any charger other than that specifically provided for use with this equipment.
- Do not use any battery which is not designed or recommended by Fluke for use with the Product.
- Take careful notice of correct placement of the battery in the product or the External Battery Charger.
- Do not short-circuit a battery pack. Do not keep battery packs in a place where the terminals can be shorted by metal objects (e.g. coins, paperclips, pens or other).
- Never use a battery pack or charger showing visible damage.
- Batteries contain hazardous chemicals that can cause burns or explode. If exposure to chemicals occurs, clean with water and get medical aid. Repair the product before use if the battery leaks.

- Alteration of battery pack: there shall be no attempt to open, modify, reform or repair a battery pack, which appears to be malfunctioning, or which has been physically damaged.
- Do not disassemble or crush battery packs
- Use the battery only in the application for which it is intended.
- Retain the original product information for future reference.

Recommendations to safe transport of battery packs

- The battery pack must adequately be protected against short-circuit or damage during transport.
- Always consult the IATA guidelines describing safe air transport of Li-ion batteries. Refer also to the section in the beginning of this paragraph on safe use of the battery pack.
- Check-in luggage: battery packs are only allowed when installed in the Product.
- Hand carried luggage: a number of battery packs as required for normal and individual use is allowed.
- Always consult national/local guidelines that are applicable for shipment by mail or other transporters.
- A maximum of 3 battery packs may be shipped by mail. The package must be marked as follows:

PACKAGE CONTAINS LITHIUM-ION BATTERIES
(NO LITHIUM METAL).

Recommendations to safe disposal of a battery pack.

- A failed battery pack shall be properly disposed of in accordance with local regulations.
- Dispose of properly: do not dispose of the battery as unsorted municipal waste. Go to Fluke's website for recycling information.
- Dispose in discharged condition and cover the battery terminals with isolation tape.

Chapter 1

Using the Scope and Meter

About this Chapter

This chapter provides a step-by-step introduction to the scope and meter functions of the test tool. The introduction does not cover all of the capabilities of the functions but gives basic examples to show how to use the menus and perform basic operations.

Powering the Test Tool

Follow the procedure (steps 1 through 3) in Figure 2 to power the test tool from a standard ac outlet. See Chapter 6 for instructions on using battery power.



Turn the test tool on with the on/off key.

The test tool powers up in its last setup configuration.

The menus to adjust date, time and information language are switched on automatically when the test tool is powered on for the first time. See Figure 2.

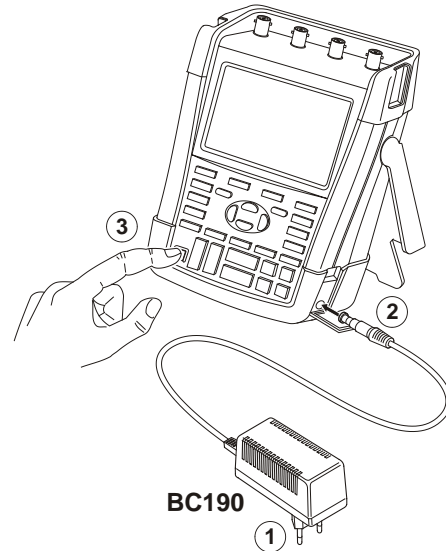



Figure 2. Powering the Test Tool

Resetting the Test Tool

If you want to reset the test tool to the factory settings, do the following:

1  Turn the test tool off.

2  Press and hold the **USER** key.

3  Press and release.

The test tool turns on, and you should hear a double beep, indicating the reset was successful.

4  Release the **USER** key.

Now look at the display; you will see a screen that looks like Figure 3.

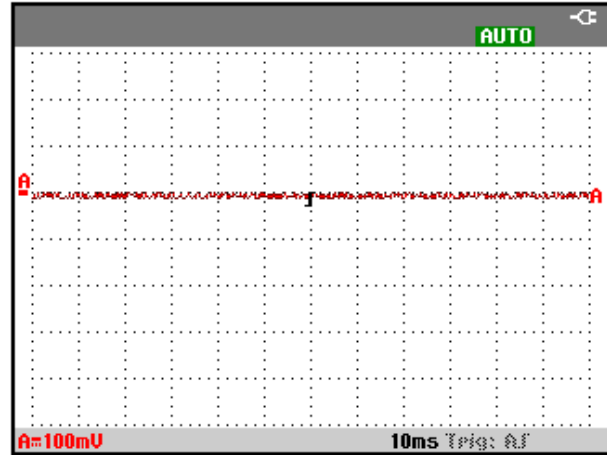



Figure 3. The Screen After Reset

Navigating a Menu

The following example shows how to use the test tool's menus to select a function. Sequentially follow steps 1 through 3 to open the scope menu and to choose an item.

1 **SCOPE** Press the **SCOPE** key to display the labels that define the present use for the four blue function keys at the bottom of the screen.



2 **F4** Open the Waveform Options menu. This menu is displayed at the bottom of the screen. Actual settings are shown on a yellow background. The setting on a black background can be changed upon operation of the blue arrow keys and confirmed with the ENTER key. See Figure 4.

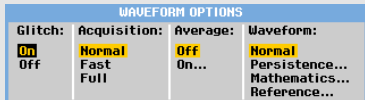
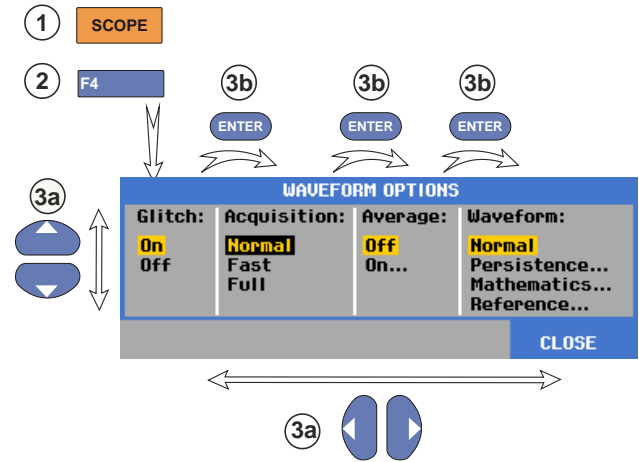





Figure 4. Basic Navigation

- 3a**  Use the blue arrow keys to highlight the item.
- 3b** Press the blue ENTER key to accept the selection. The next option will be selected. After the last option the menu will be closed.

Note

To exit the menu at any moment press  (CLOSE).

Hiding Key Labels and Menus

You can close a menu or hide key label at any time:

 Hide any key label, press again to display the key label again (toggle function).





A displayed menu will be closed.

To display menus or key labels, press one of the yellow menu keys, e.g. the SCOPE key.

You can close most menus using the  soft key CLOSE.

Key Illumination

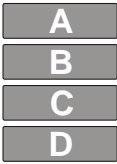
Some keys are provided with an illumination LED. For an explanation of the LED function see the table below.

	<p>On: The display is off, test tool is running. See Chapter 6 'Tips' section 'Setting the Display AUTO-Off timer'.</p> <p>Off: in all other situations</p>
	<p>On: Measurements are stopped, the screen is frozen. (HOLD)</p> <p>Off: Measurements are running. (RUN)</p>
	<p>On: The range key, the move up/down key, and the F1...F4 key labels, apply to the illuminated channel key(s).</p> <p>Off: -</p>
	<p>On: Manual operating mode.</p> <p>Off: Automatic operating mode, optimizes the waveform position, range, time base and triggering (Connect-and-View™)</p>
	<p>On: Signal is triggered</p> <p>Off: Signal is not triggered</p> <p>Flashing: waiting for a trigger at 'Single Shot' or 'On Trigger' waveform update.</p>

Input Connections

Look at the top of the test tool. The test tool has four safety BNC jack signal inputs (models 190–xx4), or two safety BNC jack inputs and two safety 4-mm banana jack inputs (models 190-xx2). See Figure 5.

Isolated input architecture allows independent floating measurements with each input.

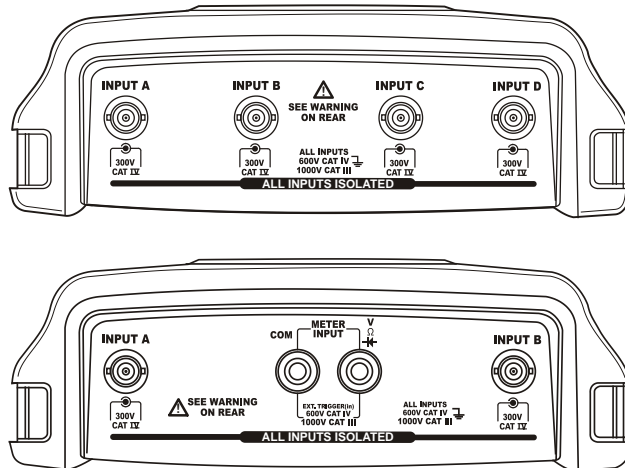

Figure 5. Measurement Connections

Making Input Connections

To make scope measurements connect the red voltage probe to input A, the blue voltage probe to input B, the grey voltage probe to input C and the green voltage probe to input D. Connect the short ground leads of **each** voltage probe to its **own** reference potential (See Figure 6).

For Meter measurements refer to the applicable section in this chapter.

Warning

To avoid electrical shock use the insulation sleeve (Figure 1 item e) if you use the probes without the hook clip or the ground spring.

Notes

- To maximally benefit from having independently isolated floating inputs and to avoid problems caused by improper use, read Chapter 6: “Tips”.
- For an accurate indication of the measured signal, it is necessary to match the probe to the test tool’s input channel. See section ‘Calibrating the voltage Probes’ in Chapter 7.

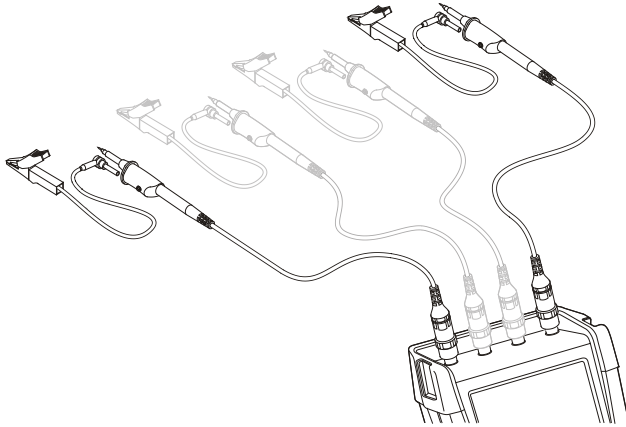



Figure 6. Scope Connections

Adjusting the Probe Type Settings

To obtain correct measurement results the test tool probe type settings must correspond to the connected probe types. To select the input A probe setting do the following:

- 1  Display the **INPUT A** key labels.

INPUT A	COUPLING	PROBE A	INPUT A
ON OFF	DC AC	1:1...	OPTIONS..

- 2  Open the **PROBE ON A** menu.

PROBE ON A		
Probe Type:	Attenuation:	
Voltage	1:1	20:1
Current	10:1	200:1
Temp	100:1	1000:1

- 3  Select the probe type **Voltage**, **Current**, or **Temp**.

- 4  **Voltage**: select the voltage probe attenuation factor.

Current and **Temp**: select the current probe or temperature probe sensitivity.

Selecting an Input Channel

To select an input channel, do the following:



Press the required channel key (A...D):

- A**
- B** - the channel is turned on
- C** - labels for the F1...F4 keys are shown. Press the channel key again to turn the labels off/on (toggle).
- D**

INPUT A ON OFF COUPLING DC AC PROBE A 1:1... INPUT A OPTIONS..

- the channel key illumination is turned on.

If the channel key is illuminated, the RANGE and MOVE UP/DOWN keys are now assigned to the indicated channel.

Tip

To set multiple channels to the same range (V/div) as, for example, input A, do the following:

- Select the input A measurement function, probe setting and input options for all involved channels
- press and hold **A**
- press **B** and/or **C** and/or **D**
- release **A**

Notice that all pressed keys are illuminated now. The MOVE UP/DOWN key and the RANGE mV/V key applies to all involved input channels.

Displaying an Unknown Signal with Connect-and-View™

The Connect-and-View feature lets the test tool display complex, unknown signals automatically. This function optimizes the position, range, time base, and triggering and assures a stable display of virtually any waveform. If the signal changes, the setup is automatically adjusted to maintain the best display result. This feature is especially useful for quickly checking several signals.

To enable the Connect-and-View feature when the test tool is in MANUAL mode, do the following:

- 1  Perform an Auto Set. **AUTO** appears at the top right of the screen, the key illumination is off.

The bottom line shows the range, the time base, and the trigger information.

The waveform identifier (**A**) is visible on the right side of the screen, as shown in Figure 7. The input A zero icon  at the left side of the screen identifies the ground level of the waveform.

- 2  Press a second time to select the manual range again. **MANUAL** appears at the top right of the screen, the key illumination is on.

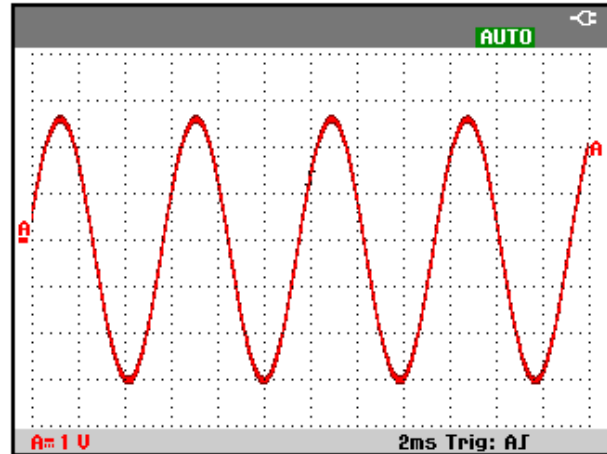



Figure 7. The Screen After an Auto Set

Use the light-gray **RANGE**, **TIME** and **MOVE** keys at the bottom of the keypad to change the view of the waveform manually.



Making Automatic Scope Measurements

The test tool offers a wide range of automatic scope measurements. In addition to the waveforms you can display four numeric readings: **READING 1 ... 4**. These readings are selectable independently, and the measurements can be done on the input A, input B, input C or input D waveform.

To choose a frequency measurement for input A, do the following:

- 1  Display the **SCOPE** key labels.

READINGS ON	READING ...	WAVEFORM OPTIONS...
OFF		
- 2  Open the **READING ..** menu.

READING 1				
on A	U ac	A ac...	Hz	Temp...
on B	U dc	A dc...	Rise time	dB...
on C	U ac+dc	A ac+dc...	Fall time	mAs
on D	Peak...	Power...	Pulse...	U/Hz
Off	U pwm...	Phase	Duty...	
READINGS 1 2 3 4				CLOSE
- 3  Select the reading number to be displayed, for example **READING 1**.
- 4  Select **on A**. Observe that the highlight jumps to the present measurement.



- 5  Select the **Hz** measurement.

Observe that the top left of the screen displays the Hz measurement. (See Figure 8.)

To choose also a **Peak-Peak** measurement for Input B as second reading, do the following:

- 1  Display the **SCOPE** key labels.

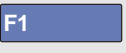
READINGS ON	READING ...	WAVEFORM OPTIONS...
OFF		
- 2  Open the **READING ..** menu.

READING 1				
on A	U ac	A ac...	Hz	Temp...
on B	U dc	A dc...	Rise time	dB...
on C	U ac+dc	A ac+dc...	Fall time	mAs
on D	Peak...	Power...	Pulse...	U/Hz
Off	U pwm...	Phase	Duty...	
READINGS 1 2 3 4				CLOSE
- 3  Select the reading number to be displayed, for example **READING 2**
- 4  Select **on B**. The highlight jumps to the measurements field.

5  Open the PEAK menu.

PEAK

Peak Type:

Peak Max 

Peak-Peak 

Peak Min 

6  Select the **Peak-Peak** measurement.

Figure 8 shows an example of the screen with two readings. The character size will be reduced when more than two readings are on.

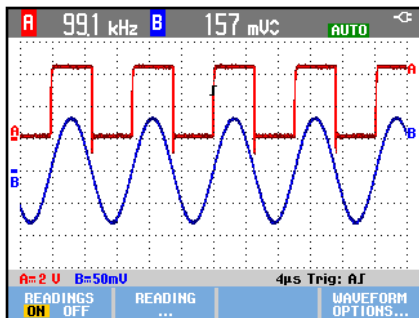



Figure 8. Hz and V peak-peak as Scope Readings

Freezing the Screen



You can freeze the screen (all readings and waveforms) at any time.



- 1  Freeze the screen. **HOLD** appears at the right of the reading area. The key illumination is on.
- 2  Resume your measurement. The key illumination is off.

Using Average, Persistence and Glitch Capture

Using Average for Smoothing Waveforms

To smooth the waveform, do the following:

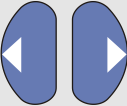
- 1  Display the **SCOPE** key labels.
- 2  Open the **WAVEFORM OPTIONS** menu.

WAVEFORM OPTIONS			
Glitch: On Off	Acquisition: Normal Fast Full	Average: Off On...	Waveform: Normal Persistence... Mathematics... Reference...
- 3  Jump to **Average**:
- 4  Select **On...** to open the **AVERAGE** menu.

AVERAGE	
Average Factor:	Average:
Average 2	Normal
Average 4	Smart
Average 8	
Average 64	

- 5  Select **Average factor: Average 64**. This averages the outcomes of 64 acquisitions.

- 6  Select **Average: Normal** (normal average) or **Smart** (smart average, see below).

You can use the average functions to suppress random or uncorrelated noise in the waveform without loss of bandwidth. Waveform samples with and without smoothing are shown in Figure 9.

Smart average

In the normal average mode occasional deviations in a waveform just distort the averaged wave shape, and do not show up on screen clearly. When a signal really changes, for instance when you probe around, it takes quite some time before the new wave shape is stable. With smart averaging you can quickly probe around, and incidental waveform changes like a line flyback in video show up on screen instantly.

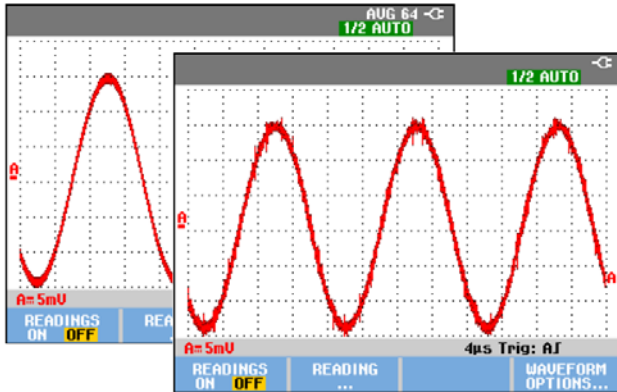





Figure 9. Smoothing a Waveform

Using Persistence, Envelope and Dot-Join to Display Waveforms

You can use Persistence to observe dynamic signals. See Figure 10.

- 1  Display the **SCOPE** key labels.
- 2  Open the **WAVEFORM OPTIONS** menu.

WAVEFORM OPTIONS			
Glitch:	Acquisition:	Average:	Waveform:
On	Normal	Off	Normal
Off	Fast	On...	Persistence...
	Full		Mathematics...
			Reference...
- 3  Jump to **Waveform:** and open the **Persistence...** menu.

PERSISTENCE	
Digital Persistence:	Display:
Off	Normal
Short	Envelope
Medium	Dot-join OFF
Long	
- 4  Select **Digital Persistence: Short, Medium, Long** or **Infinite** to observe dynamic waveforms like on an analog oscilloscope.
 Select **Digital Persistence: Off**, **Display: Envelope** to see the upper and lower boundaries of dynamic waveforms (envelope mode).

Select **Display: Dot-join: Off** to display measured samples only. Dot join off may be useful when measuring for example modulated signals or video signals.

Select **Display: Normal** to turn the envelope mode off and the dot-join function on.

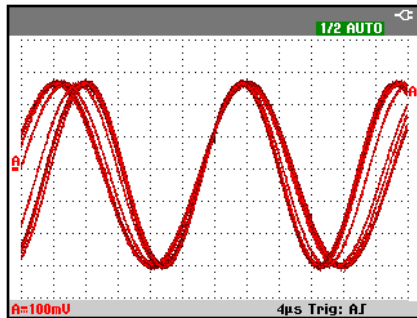

Figure 10. Using Persistence to Observe Dynamic Signals

Displaying Glitches

To capture glitches on a waveform, do the following:

1 **SCOPE** Display the **SCOPE** key labels.

2 **F4** Open the **WAVEFORM OPTIONS** menu.

WAVEFORM OPTIONS			
Glitch:	Acquisition:	Average:	Waveform:
On Off	Normal Fast Full	Off On...	Normal Persistence... Mathematics... Reference...

3  Select **Glitch: On**.



4 **F4** Exit the menu.



You can use this function to display events (glitches or other asynchronous waveforms) of 8 ns (8 nanoseconds, due to ADC's with 125 MS/s sampling speed) or wider, or you can display HF modulated waveforms.

When you select the 2 mV/div range Glitch Detect will automatically be turned Off. In the 2 mV/div range you can set Glitch Detect On manually.

Suppressing High Frequency Noise

Switching the glitch detection off (**Glitch: Off**) will suppress the high frequency noise on a waveform. Averaging will suppress the noise even more.

- 1  Display the **SCOPE** key labels.
- 2  Open the **WAVEFORM OPTIONS** menu.

WAVEFORM OPTIONS			
Glitch:	Acquisition:	Average:	Waveform:
On	Normal	Off	Normal
Off	Fast	On...	Persistence...
	Full		Mathematics...
			Reference...
- 3  Select **Glitch: Off**, then select **Average: On...** to open the **AVERAGE** menu.
- 4  Select **Average 8**.



See also Using Average for Smoothing Waveforms on page 21.

Glitch capture and average do not affect bandwidth. Further noise suppression is possible with bandwidth limiting filters. See Working with Noisy Waveforms on page 27.

Acquiring Waveforms

Setting the Acquisition Speed and Waveform Memory Depth

To set the acquisition speed, do the following:

- 1  Display the **SCOPE** key labels.
- 2  Open the **WAVEFORM OPTIONS** menu.

WAVEFORM OPTIONS			
Glitch:	Acquisition:	Average:	Waveform:
On	Normal	Off	Normal
Off	Fast	On...	Persistence...
	Full		Mathematics...
			Reference...
- 3  Select **Acquisition:**
 - Fast** – for fast waveform update rate; shortest record length, decreased zoom rate, no readings possible.
 - Full** – maximum waveform detail; 10,000 samples per waveform record length, maximum zoom rate, lower waveform update rate.

Normal – optimal waveform update rate and zoom range combination

4 **F4** Exit the menu.

See also Table 2 in Chapter 8.

Selecting AC-Coupling

After a reset, the test tool is dc-coupled so that ac and dc voltages appear on the screen.

Use ac-coupling when you wish to observe a small ac signal that rides on a dc signal. To select ac-coupling, do the following:

1 **A** Display the **INPUT A** key labels.



2 **F2** Highlight **AC**.

Observe that the bottom left of the screen displays the ac-coupling icon: .

You can define how Auto Set affects this setting, see Chapter 6 'Changing the Auto Set Options'.

Reversing the Polarity of the Displayed Waveform

To invert, for example the input A waveform, do the following:

1 **A** Display the **INPUT A** key labels.



2 **F4** Open the **INPUT A** menu.



3  Select **Inverted** and accept inverted waveform display.

4 **F4** Exit the menu.

For example, a negative-going waveform is displayed as positive-going waveform which may provide a more meaningful view. An inverted display is identified by an inverted waveform identifier () at the right of the waveform, and in the status line below the waveform.

Variable Input Sensitivity

The variable input sensitivity allows you to adjust any input sensitivity continuously, for example to set the amplitude of a reference signal to exactly 6 divisions.

The input sensitivity of a range can be increased up to 2.5 times, for example between 10 mV/div and 4 mV/div in the 10 mV/div range.

To use the variable input sensitivity on for example input A, do the following:



- 1 Apply the input signal.
- 2  Perform an Auto Set (AUTO must appear at the top of the screen).

An Auto Set will turn off the variable input sensitivity. You can now select the required input range. Keep in mind that the sensitivity will increase when you start adjusting the variable sensitivity (the displayed waveform amplitude will increase).

- 3  Display the **INPUT A** key labels.

INPUT A ON OFF	COUPLING DC AC	PROBE A 1:1...	INPUT A OPTIONS..
-------------------	-------------------	-------------------	----------------------

- 4  Open the **INPUT A** menu.

INPUT A	
Polarity:	Bandwidth:
Normal	Full
Inverted	20 MHz
Variable	10 kHz
- 5  Select and accept **Variable**.
- 6  Exit the menu.

At the bottom left of the screen the text **A Var** is displayed.

Selecting Variable will turn off cursors and automatic input ranging.

- 7  Press **mV** to increase the sensitivity, press **V** to decrease the sensitivity.

Note

Variable input sensitivity is not available in the Mathematics functions (+ - x and Spectrum).

Working with Noisy Waveforms

To suppress high frequency noise on waveforms, you can limit the working bandwidth to 10 kHz or 20 MHz. This function smoothes the displayed waveform. For the same reason, it improves triggering on the waveform.

To choose the 10 kHz bandwidth on for example input A, do the following:

-  Display the **INPUT A** key labels.

INPUT A	COUPLING	PROBE A	INPUT A
OH OFF	DC AC	1:1...	OPTIONS..
-  Open the **INPUT A** menu.

INPUT A	
Polarity:	Bandwidth:
Normal	Full
Inverted	20 MHz
Variable	10 kHz
-  Jump to **Bandwidth:** and select **10kHz** to accept the bandwidth limitation.

Tip

To suppress noise without loss of bandwidth, use the average function or turn off **Display Glitches**.



Using Mathematics Functions +, -, x, XY-mode

You can add (+), subtract (-), or multiply (x) two waveforms. The test tool will display the mathematical result waveform and the source waveforms.

The XY-mode provides a plot with one input on the vertical axis and the second input on the horizontal axis.



The Mathematics functions perform a point-to-point operation on the involved waveforms.





To use a Mathematics function, do the following:

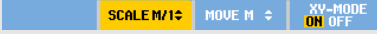

-  Display the **SCOPE** key labels.
-  Open the **WAVEFORM OPTIONS** menu.

WAVEFORM OPTIONS			
Glitch:	Acquisition:	Average:	Waveform:
On	Normal	Off	Normal
Off	Fast	On...	Persistence...
	Full		Mathematics...
			Reference...
-  Jump to **Waveform:** and Select **Mathematics...** to open the **Mathematics** menu.

MATHEMATICS		
Function:	Source 1	Source 2:
Off	A	A
+	B	B
-	C	C
x	D	D
		Spectrum

- 4  Select Function: +, -, x or XY-mode.
- 5  Select the first waveform: **Source 1: A, B, C or D**
- 6  Select the second waveform: **Source 2: A, B, C or D**

The mathematical function key labels will be displayed now:

- 7  Press   to select a scale factor to fit the result waveform onto the display.

 Press   to move the result waveform up or down.

 Switch the result waveform on/off (toggle).

The sensitivity range of the mathematical result is equal to the sensitivity range of the least sensitive input divided by the scale factor.

Using Mathematics Function Spectrum (FFT)



The Spectrum function shows the spectral content of the input A, B, C or D waveform in the input waveform color. It performs an FFT (Fast Fourier Transform) to transform the amplitude waveform from the time domain into the frequency domain.

To reduce the effect of side-lobes (leakage) it is recommended to use Auto windowing. This will automatically adapt the part of the waveform that is analyzed to a complete number of cycles

Selecting Hanning, Hamming or no windowing results in a faster update, but also in more leakage.

Ensure that the entire waveform amplitude remains on the screen.

To use the Spectrum function, do the following:

- 1  Display the **SCOPE** key labels.
- 2  Open the **Waveform Options** menu.

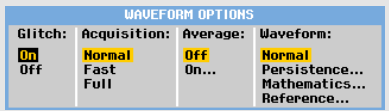

3  Jump to **Waveform:** and select **Mathematics...** to open the **Mathematics** menu.

MATHEMATICS		
Function:	Source:	Window:
Off	A	Auto
+	B	Hamming
-	C	Hanning
x	D	None

4  Select **Function: Spectrum**.

5  Select the source waveform for the spectrum: **Source : A, B, C or D**

6  Select **Window: Auto** (automatic windowing), **Hanning**, **Hamming**, or **None** (no windowing).

You will see a screen that looks like Figure 11.

Observe that the top right of the screen displays SPECTRUM.

If it displays LOW AMPL a spectrum measurement cannot be done as the waveform amplitude is too low.

If it displays WRONG TB the time base setting does not enable the test tool to display an FFT result. It is either too slow, which can result in aliasing, or too fast, which results in less than one signal period on the screen.

7  Perform a spectrum analysis on waveform A, B, C or D.

8  Set the horizontal amplitude scale to linear or logarithmic.

9  Set the vertical amplitude scale to linear or logarithmic.

10  Turn the spectrum function off/on (toggle function).

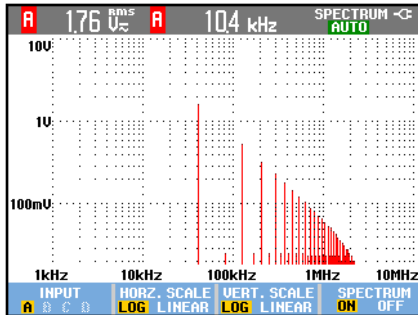

Figure 11. Spectrum Measurement

Comparing Waveforms

You can display a fixed reference waveform with the actual waveform for comparison.

To create a reference waveform and to display it with the actual waveform, do the following:

1 **SCOPE** Display the **SCOPE** key labels.

2 **F4** Open the **Waveform Options** menu.

WAVEFORM OPTIONS			
Glitch:	Acquisition:	Average:	Waveform:
On Off	Normal Fast Full	Off On...	Normal Persistence... Mathematics... Reference...

3  Jump to the **Waveform** field and select **Reference...** to open the **WAVEFORM REFERENCE** menu.

WAVEFORM REFERENCE	
Reference:	Pass/Fail Testing:
On Off New... Recall...	Off Store "Fail" Store "Pass"

4



Select **On** to display the reference waveform. This can be:

- the last used reference waveform (if not available no reference waveform will be shown).
- the envelope waveform if the persistence function Envelope is on.

Select **Recall...** to recall a saved waveform (or waveform envelope) from memory and use it as a reference waveform.

Select **New...** to open the **NEW REFERENCE** menu.

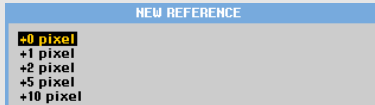

If you selected **New...** continue at step 5, else go to step 6.

5



Select the width of an additional envelope to be added to the momentary waveform.

6



Store the momentary waveform and display it permanently for reference. The display also shows the actual waveform.

To recall a saved waveform from memory and use it as a reference waveform, refer also to Chapter 5 Recalling Screens with Associated Setups.

Example of reference waveform with an additional envelope of ± 2 pixels:

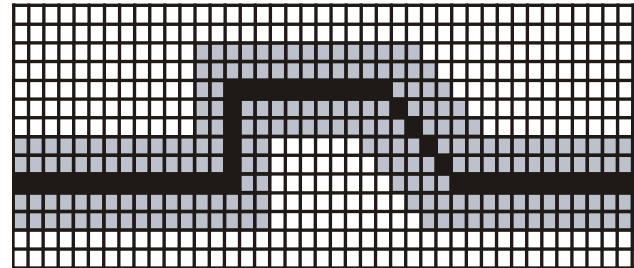

black pixels: basic waveform
gray pixels: ± 2 pixels envelope

1 vertical pixel on the display is $0.04 \times \text{range/div}$
1 horizontal pixel on the display is $0.0333 \times \text{range/div}$.

Pass - Fail Testing

You can use a reference waveform as a test template for the actual waveform. If at least one sample of a waveform is outside the test template, the failed or passed scope screen will be stored. Up to 100 screens can be stored. If the memory is full, the first screen will be deleted in favor of the new screen to be stored.

The most appropriate reference waveform for the Pass-Fail test is a waveform envelope.

To use the Pass - Fail function using a waveform envelope, do the following:

1 Display a reference waveform as described in the previous section “Comparing Waveforms”

2  From the **Pass Fail Testing:** menu select

Store “Fail” : each scope screen with samples outside the reference will be stored

Store “Pass” : each scope screen with no samples outside the reference will be stored

Each time a scope screen is stored you will hear a beep. Chapter 3 provides information on how to analyze the stored screens.

Analyzing Waveforms

You can use the analysis functions **CURSOR**, **ZOOM** and **REPLAY** to perform detailed waveform analysis. These functions are described in Chapter 3: “Using Cursors, Zoom and Replay”.

Making Automatic Meter Measurements (for models 190-xx4)

The test tool offers a wide range of automatic meter measurements. You can display four large numeric readings: **READING 1 ... 4**. These readings are selectable independently, and the measurements can be done on the input A, B, C or input D waveform. In METER mode the waveforms are not displayed. The 10 kHz HF rejection filter (see Working with Noisy Waveforms on page 27) is always on in the METER mode.

Selecting a Meter Measurement

To choose a current measurement for input A, do the following:

1	METER	Display the METER key labels.																																
<table border="1" style="width: 100%;"> <tr> <td>MEASURE...</td> <td>RELATIVE ON OFF</td> <td>ADJUST REFERENCE...</td> </tr> </table>			MEASURE...	RELATIVE ON OFF	ADJUST REFERENCE...																													
MEASURE...	RELATIVE ON OFF	ADJUST REFERENCE...																																
2	F1	Open the Reading .. menu.																																
<table border="1" style="width: 100%;"> <thead> <tr> <th colspan="4">READING 1</th> </tr> </thead> <tbody> <tr> <td>on A</td> <td>U ac</td> <td>A ac</td> <td>Temp...</td> </tr> <tr> <td>on B</td> <td>U dc</td> <td>A dc</td> <td></td> </tr> <tr> <td>on C</td> <td>U ac+dc</td> <td>A ac+dc</td> <td></td> </tr> <tr> <td>on D</td> <td></td> <td></td> <td></td> </tr> <tr> <td>Off</td> <td></td> <td></td> <td></td> </tr> <tr> <td colspan="2">READINGS</td> <td></td> <td>CLOSE</td> </tr> <tr> <td>1</td> <td>2</td> <td>3</td> <td>4</td> </tr> </tbody> </table>			READING 1				on A	U ac	A ac	Temp...	on B	U dc	A dc		on C	U ac+dc	A ac+dc		on D				Off				READINGS			CLOSE	1	2	3	4
READING 1																																		
on A	U ac	A ac	Temp...																															
on B	U dc	A dc																																
on C	U ac+dc	A ac+dc																																
on D																																		
Off																																		
READINGS			CLOSE																															
1	2	3	4																															

3	F1	Select the reading number to be displayed, for example READING 1
4		Select on A . Observe that the highlight jumps to the present measurement.
5		Select the A dc... measurement.
6		Select a current probe sensitivity that matches the connected current probe (see Adjusting the Probe Type Settings on page 16.)

You will see a screen like in Figure 12.

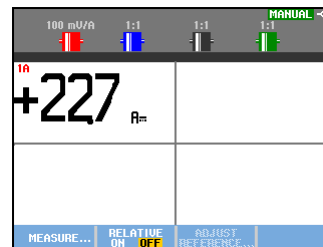

Figure 12. Meter Screen

Making Relative Meter Measurements

A relative measurement displays the present measurement result relative to a defined reference value.

The following example shows how to perform a relative voltage measurement. First obtain a reference value:

- 1 METER Display the **METER** key labels.

MEASURE...
RELATIVE
ON OFF
ADJUST
REFERENCE...
- 2 Measure a voltage to be used as reference value.
- 3 F2 Set **RELATIVE** to **ON**. (**ON** is highlighted.) This stores the reference value as reference for subsequent measurements. Observe the **ADJUST REFERENCE** soft key (F3) that enables you to adjust the reference value (see step 5 below).
- 4 Measure the voltage to be compared to the reference.

Now the large reading is the actual input value minus the stored reference value. The actual input value is displayed below the large reading (ACTUAL: xxxx), see Figure 13.

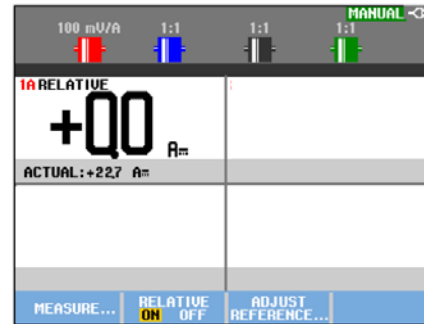







Figure 13. Making a Relative Measurement

You can use this feature when, for example, you need to monitor input activity (voltage, temperature) in relation to a known good value.

Adjusting the reference value

To adjust the reference value, do the following:

- | | | |
|---|-----------------------------------------------------------------------------------|------------------------------------------------------------|
| 5 |  | Display the Adjust Reference menu. |
| 6 |  | Select the applicable relative measurement reading. |
| 7 |  | Select the digit you want to adjust. |
| 8 |  | Adjust the digit. Repeat step 7 and step 8 until finished. |
| 9 |  | Enter the new reference value. |

Making Multimeter Measurements (for models 190-xx2)

The screen displays the numeric readings of the measurements on the meter input.

Making Meter Connections

Use the two 4-mm safety red ($V\Omega$) and black (COM) banana jack inputs for the Meter functions. (See Figure 14.)

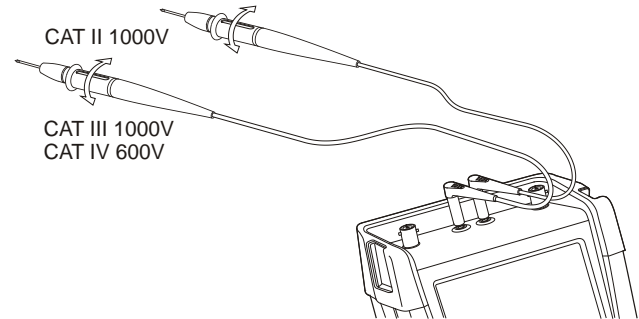



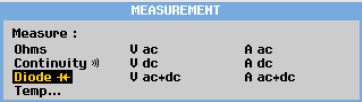



Figure 14. Meter Connections

Measuring Resistance Values

To measure a resistance, do the following:

- 1 Connect the red and black test leads from the 4-mm banana jack inputs to the resistor.
- 2  Display the METER key labels.

- 3  Open the MEASUREMENT menu.

MEASUREMENT		
Measure :	V ac	A ac
Ohms	V dc	A dc
Continuity ^{*)}	V ac+dc	A ac+dc
Diode ^{*)}		
Temp...		
- 4  Highlight **Ohms**.
- 5  Select Ohms measurement.

The resistor value is displayed in ohms. Observe also that the bargraph is displayed. (See 15.)

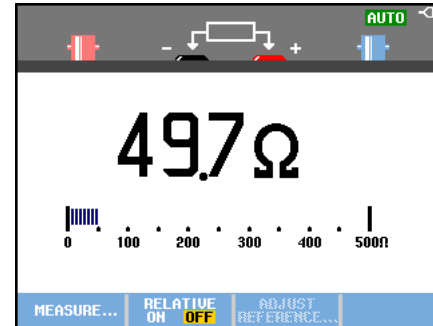

Figure 15. Resistor Value Readings

Making a Current Measurement

You can measure current in both Scope mode and Meter mode. Scope mode has the advantage of waveforms being displayed while you perform measurements. Meter mode has the advantage of high measurement resolution.

The next example explains a typical current measurement in Meter mode.

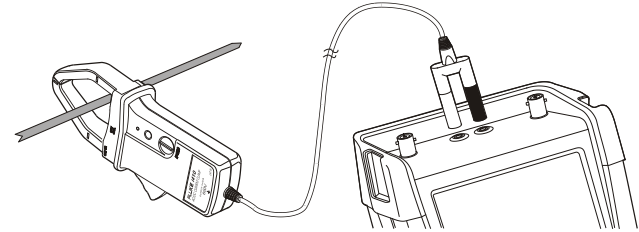

Figure 16. Measurement Setup

Warning

Carefully read the instructions about the current probe you are using.

To set up the test tool, do the following:

- 1 Connect a current probe (e.g. Fluke i410, optional) between the 4-mm banana jack inputs and the conductor to be measured.

Ensure that the red and black connectors correspond to the red and black banana jack inputs. (See Figure 16.)

- 2  Display the **METER** key labels.





- 3  Open the **MEASUREMENT** menu.

MEASUREMENT		
Measure :		
Ohms	U ac	A ac
Continuity \Rightarrow	U dc	A dc
Diode \rightarrow	U ac+dc	A ac+dc
Temp...		

- 4  Highlight **A ac**.

- 5  Open the **CURRENT PROBE** submenu.

CURRENT PROBE	
Sensitivity:	
100 μ V/A	400 mV/A
1 mV/A	1 V/A
10 mV/A	10 V/A
100 mV/A	100 V/A

- 6  Observe the sensitivity of the current probe. Highlight the corresponding sensitivity in the menu, e.g. 1 mV/A.
- 7  Accept the current measurement.

Now, you will see a screen like in Figure 17.

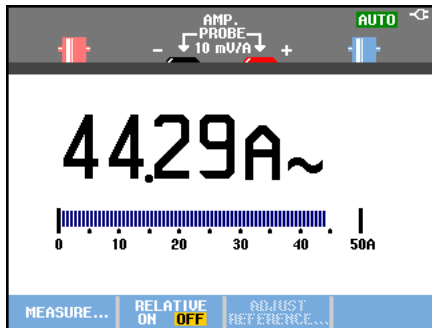





Figure 17. Ampere Measurement Readings

Selecting Auto/Manual Ranges

To activate manual ranging, do the following during any Meter measurement:

- 1  Activate manual ranging.
- 2  Increase (V) or decrease (mV) the range.
- 3  Choose auto ranging again.

Observe how the bargraph sensitivity changes.

Use manual ranging to set a fixed bargraph sensitivity and decimal point.

When in auto ranging, the bargraph sensitivity and decimal point are automatically adjusted while checking different signals.

Making Relative Meter Measurements

A relative measurement displays the present measurement result relative to a defined reference value.

The following example shows how to perform a relative voltage measurement. First obtain a reference value:

1	METER	Display the METER key labels.
		MEASURE... RELATIVE ON OFF ADJUST REFERENCE...
2		Measure a voltage to be used as reference value.
3	F2	Set RELATIVE to ON . (ON is highlighted.) This stores the reference value as reference for subsequent measurements. Observe the ADJUST REFERENCE soft key (F3) that enables you to adjust the reference value (see step 5 below).
4		Measure the voltage to be compared to the reference.

Now the large reading is the actual input value minus the stored reference value. The bargraph indicates the actual input value. The actual input value and the reference value are displayed below the large reading (ACTUAL: xxxx REFERENCE: xxx), see Figure 18.

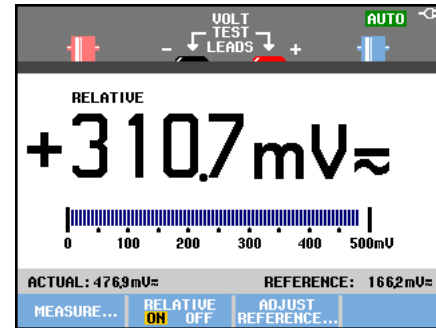





Figure 18. Making a Relative Measurement

You can use this feature when, for example, you need to monitor input activity (voltage, temperature) in relation to a known good value.

Adjusting the reference value

To adjust the reference value, do the following:

- | | | |
|---|-----------------------------------------------------------------------------------|------------------------------------------------------------|
| 5 |  | Display the Adjust Reference menu. |
| 6 |  | Select the digit you want to adjust. |
| 7 |  | Adjust the digit. Repeat step 6 and step 7 until finished. |
| 8 |  | Enter the new reference value. |

Chapter 2

Using The Recorder Functions

About this Chapter

This chapter provides a step-by-step introduction to the recorder functions of the test tool. The introduction gives examples to show how to use the menus and perform basic operations.

Opening the Recorder Main Menu

First choose a measurement in scope or meter mode. Now you can choose the recorder functions from the recorder main menu. To open the main menu, do the following:

1



Open the recorder main menu. (See Figure 19).

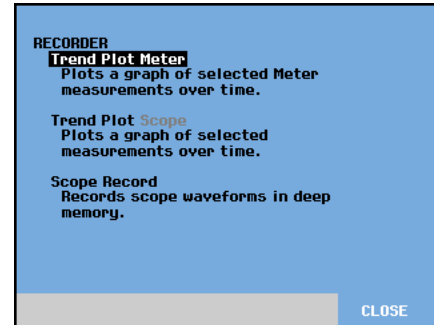

Figure 19. Recorder Main Menu

Trendplot Meter is only present in models 190-xx2.

Plotting Measurements Over Time (TrendPlot™)



Use the TrendPlot function to plot a graph of Scope or Meter measurements (readings) as function of time.

Note

Because the navigations for the TrendPlot Scope and the TrendPlot Meter are identical, only Scope TrendPlot is explained in the next sections.

Starting a TrendPlot Function

To start a TrendPlot, do the following:

- 1 Make automatic Scope or Meter measurements, see Chapter 1. The readings will be plotted!
- 2  Open the **RECORDER** main menu.
- 3  Highlight **Trend Plot**.
- 4  Start the TrendPlot recording.

The test tool continuously records the digital readings of the measurements and displays these as a graph. The TrendPlot graph rolls from right to left like a paper chart recorder.

Observe that the recorded time from start appears at the bottom of the screen. The present reading appears on top of the screen. (See Figure 20.)

Note

When simultaneously TrendPlotting two readings, the screen area is split into two sections of four divisions each. When simultaneously TrendPlotting three or four readings, the screen area is split into three or four sections of two divisions each.

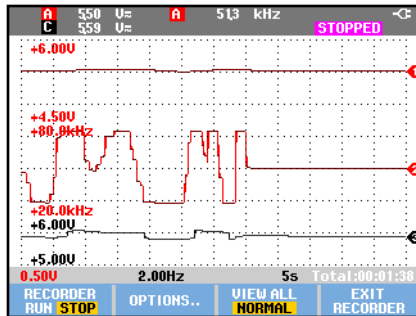

Figure 20. TrendPlot Reading

When the test tool is in automatic mode, automatic vertical scaling is used to fit the TrendPlot graph on the screen.

- | | | |
|----------|-----------|-------------------------------------------------------|
| 5 | F1 | Set RECORDER to STOP to freeze the recorder function. |
| 6 | F1 | Set RECORDER to RUN to restart. |

Note

Scope TrendPlot is not possible on cursor related measurements. As an alternative you may use the PC software FlukeView® ScopeMeter®.

Displaying Recorded Data

When in normal view (**NORMAL**), only the twelve most recently recorded divisions are displayed on screen. All previous recordings are stored in memory.

VIEW ALL shows **all** data in memory:

7  Display an overview of the full waveform.

Press  repeatedly to toggle between normal view (**NORMAL**) and overview (**VIEW ALL**).

When the recorder memory is full, an automatic compression algorithm is used to compress all samples into half of the memory without loss of transients. The other half of the recorder memory is free again to continue recording.

Changing the Recorder Options

At the lower right of the display, the status line indicates a time. You can choose this time to represent either the start time of the recording ('Time of Day') or the time elapsed since the start of the recording ('From Start').

To change the time reference, proceed from step 6 as follows:

7  Open the **RECORDER OPTIONS** menu.



8  Select **Time of Day** or **From Start**.

Turning Off the TrendPlot Display



9  Exit the recorder function.

Recording Scope Waveforms In Deep Memory (Scope Record)

The **SCOPE RECORD** function is a roll mode that logs a long waveform of each active input. This function can be used to monitor waveforms like motion control signals or the power-on event of an Uninterruptable Power Supply (UPS). During recording, fast transients are captured. Because of the deep memory, recording can be done for more than one day. This function is similar to the roll mode in many DSO's but has deeper memory and better functionality.

Starting a Scope Record Function

To record for example the input A and input B waveform, do the following:

- 1 Apply a signal to input A and input B.
- 2  Open the **RECORDER** main menu.
- 3  From the Recorder main menu, highlight **Scope Record** and Start the recording.

The waveform moves across the screen from right to left like on a normal chart recorder. (See Figure 21).

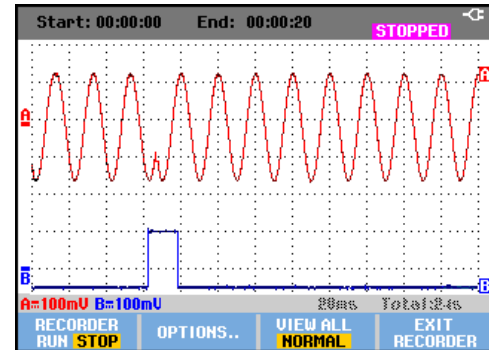

Figure 21. Recording Waveforms

Observe that the screen displays the following:

- Time from start at the top of the screen.
- The status at the bottom of the screen which includes the time/div setting as well as the total timespan that fits the memory.

Note

For accurate recordings it is advised to let the instrument first warm up for five minutes.

Displaying Recorded Data

In Normal view, the samples that roll off the screen are stored in deep memory. When the memory is full, recording continues by shifting the data in memory and deleting the first samples out of memory.

In View All mode, the complete memory contents are displayed on the screen.

4  Press to toggle between **VIEW ALL** (overview of all recorded samples) and **NORMAL** view.

You can analyze the recorded waveforms using the Cursors and Zoom functions. See Chapter 3: “Using Replay, Zoom and Cursors”.

Using Scope Record in Single Sweep Mode

Use the recorder **Single Sweep** function to automatically stop recording when the deep memory is full.

Continue from step 3 of the previous section:

4  Stop recording to unlock the **OPTIONS...** softkey.

5  Open the **RECORDER OPTIONS** menu.

RECORDER OPTIONS		
Reference:	Display Glitches:	Mode:
Time of Day From Start	Glitch On 20 kHz	Single Sweep Continuous on Trigger ...

6  Jump to the **Mode** field, select **Single Sweep** and accept the recorder options.

7  Start recording.

Using Triggering to Start or Stop Scope Record

To record an electrical event that causes a fault, it might be useful to start or stop recording on a trigger signal: **Start on trigger** to start recording; recording stops when the deep memory is full

Stop on trigger to stop recording.

Stop when untriggered to continue recording as long as a next trigger comes within 1 division in view all mode.

For the models 190-xx4 the signal on the BNC input that has been selected as trigger source must cause the trigger.

For the models 190-xx2 the signal applied to the banana jack inputs (**EXT TRIGGER (in)**). signal must cause the trigger. The trigger source is automatically set to **Ext.** (external).

To set up the test tool, continue from step 3 of the previous section:

4 Apply the signal to be recorded to the BNC input(s).

5  Stop recording to unlock the **OPTIONS...** softkey.

6



Open the **RECORDER OPTIONS** menu.



7



Jump to the **Mode:** field, select **on Trigger...** (models 190-xx4) or **on Ext.** (models 190-xx2) to open the **START SINGLE SWEEP ON TRIGGERING** or the **START SINGLE SWEEP ON EXT.** menu.

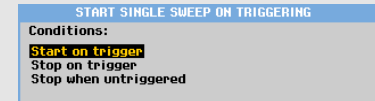



8



Select one of the **Conditions:** and accept the selection.

For external triggering (190-xx2) continue at step 9.

- 9  Select the desired trigger slope (**Slope:**) and jump to **Level:**.
- 10  Select the 0.12V or 1.2V trigger level and accept all recorder options.
- 11 Apply a trigger signal to the red and black ext. trigger banana inputs.

During recording samples are continuously saved in deep memory. The last twelve recorded divisions are displayed on the screen. See Figure 22. Use View All to display the full memory contents.

Note

To learn more about the Single Shot trigger function, see Chapter 4 “Triggering on Waveforms”.

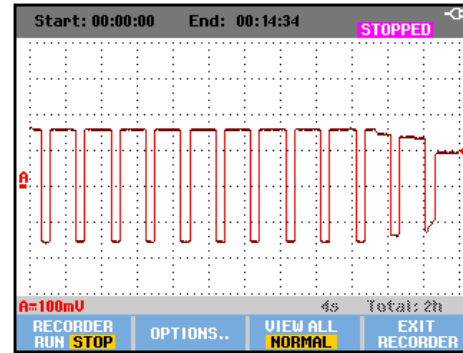

Figure 22. Triggered Single Sweep Recording

Analyzing a TrendPlot or Scope Record

From a TrendPlot or Scope Record you can use the analysis functions CURSORS and ZOOM to perform detailed waveform analysis. These functions are described in Chapter 3: “Using Replay, Zoom and Cursors”.

Chapter 3

Using Replay, Zoom and Cursors

About this Chapter

This chapter covers the capabilities of the analysis functions **Cursor**, **Zoom**, and **Replay**. These functions can be used with one or more of the primary functions Scope, TrendPlot or Scope Record.

It is possible to combine two or three analysis functions. A typical application using these functions follows:

- First **replay** the last screens to find the screen of special interest.
- Then **zoom** in on the signal event.
- Finally, make measurements using the **cursors**.

Replaying the 100 Most Recent Scope Screens

When you are in scope mode, the test tool automatically stores the 100 most recent screens. When you press the **HOLD** key or the **REPLAY** key, the memory contents are frozen. Use the functions in the **REPLAY** menu to “go back in time” by stepping through the stored screens to find the screen of your interest. This feature lets you capture and view signals even if you did not press **HOLD**.

Replaying Step-by-Step

To step through the last scope screens, do the following:

- 1** **REPLAY** From scope mode, open the REPLAY menu.

Observe that the waveform is frozen and that REPLAY appears at the top of the screen (see Figure 23).
- 2** **F1** Step through the previous screens.
- 3** **F2** Step through the next screens.

Observe that the bottom of the waveform area displays the replay bar with a screen number and related time stamp:

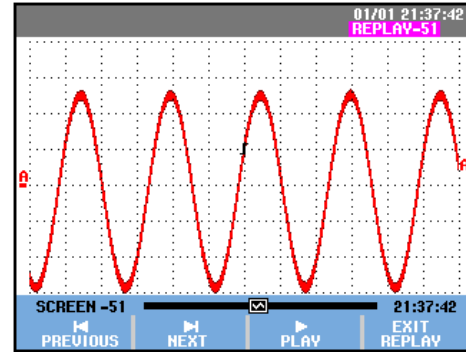



Figure 23. Replaying a Waveform



The replay bar represents all 100 stored screens in memory. The  icon represents the picture being displayed on the screen (in this example: SCREEN -51). If the bar is partly white, the memory is not completely filled with 100 screens.

From this point you can use the zoom and cursor functions to study the signal in more detail.

Replaying Continuously

You can also replay the stored screens continuously, like playing a video tape.

To replay continuously, do the following:

- 1**  From Scope mode, open the **REPLAY** menu.

Observe that the waveform is frozen and **REPLAY** appears at the top of the screen.
- 2**  Continuously replay the stored screens in ascending order.

Wait until the screen with the signal event of interest appears.

- 3**  Stop the continuous replay.

Turning Off the Replay Function

- 4**  Turn off **REPLAY**.

Capturing 100 Intermittents Automatically

When you use the test tool in triggered mode, 100 *triggered* screens are captured.



By combining the trigger possibilities with the capability of capturing 100 screens for later replay, you can leave the test tool unattended to capture intermittent signal anomalies. This way you could use Pulse Triggering to trigger and capture 100 intermittent glitches or you could capture 100 UPS startups.

For triggering, see Chapter 4: “*Triggering on Waveforms*”.

Zooming in on a Waveform

To obtain a more detailed view of a waveform, you can zoom in on a waveform using the **ZOOM** function.

To zoom in on a waveform, do the following:

- 1** **ZOOM** Display the **ZOOM** key labels.

ZOOM appears at the top of the screen, and the waveform is magnified.
- 2**  Enlarge (decrease the time/div) or shrink (increase the time/div) the waveform.
- 3**  Scroll. A position bar displays the position of the zoomed part in relation to the total waveform.

Tip

*Even when the key labels are not displayed at the bottom of the screen, you can still use the arrow keys to zoom in and out. You can also use the **s TIME ns** key to zoom in and out.*

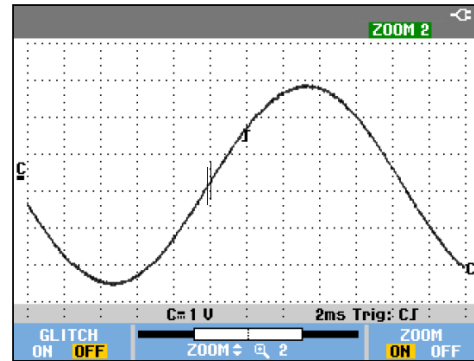

Figure 24. Zooming in a Waveform

Observe that the bottom of the waveform area displays the zoom ratio, position bar, and time/div (see Figure 24). The zoom range depends on the amount of data samples stored in memory.

Turning Off the Zoom Function

- 4** **F4** Turn off the **ZOOM** function.



Making Cursor Measurements



Cursors allow you to make precise digital measurements on waveforms. This can be done on live waveforms, recorded waveforms, and on saved waveforms.



Using Horizontal Cursors on a Waveform

To use the cursors for a voltage measurement, do the following:

- 1 **CURSOR** From scope mode, display the cursor key labels.

- 2 **F1** Press to highlight 
- 3 **F2** Highlight the upper cursor.

- 4  Move the upper cursor to the desired position on the screen.
- 5 **F2** Highlight the lower cursor.

- 6  Move the lower cursor to the desired position on the screen.

Note

Even when the key labels are not displayed at the bottom of the screen, you still can use the arrow keys. This allows full control of both cursors while having full screen view.

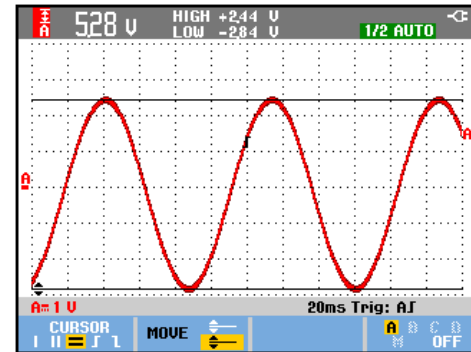

Figure 25. Voltage Measurement with Cursors

The screen shows the voltage difference between the two cursors and the voltage at the cursors. (See Figure 25.)

Use horizontal cursors to measure the amplitude, high or low value, or overshoot of a waveform.

Using Vertical Cursors on a Waveform

To use the cursors for a time measurement (T, 1/T), for a mVs-mAs-mWs measurement, or for an RMS measurement of the waveform section between the cursors, do the following:

- | | | |
|---|---------------|-----------------------------------------------------------------------------------------------|
| 1 | CURSOR | From scope mode, display the cursor key labels. |
| | | |
| 2 | F1 | Press to highlight II |
| 3 | F3 | Choose, for example, time measurement: T. |
| 4 | F4 | Choose the waveform that you want the markers to be placed on: A, B, C, D or M (Mathematics). |
| 5 | F2 | Highlight the left cursor. |
| 6 | | Move the left cursor to the desired position on the waveform. |
| 7 | F2 | Highlight the right cursor. |

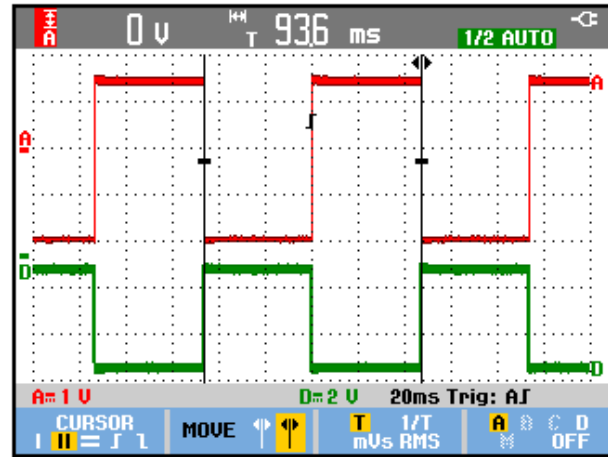

Figure 26. Time Measurement with Cursors

- | | | |
|---|--|----------------------------------------------------------------|
| 8 | | Move the right cursor to the desired position on the waveform. |
|---|--|----------------------------------------------------------------|

The screen shows the time difference between the cursors and the voltage difference between the two markers. (See Figure 26.)

- | | | |
|---|-----------|--------------------------------------------|
| 9 | F4 | Select OFF to turn off the cursors. |
|---|-----------|--------------------------------------------|

Notes

- For mVs select probe type 'Voltage'.
- For mAs select probe type 'Current'.
- For mWs select mathematical function x , and probe type 'Voltage' for one channel and 'Current' for the other channel.

Using Cursors on a Mathematical Result (+ - x) Waveform

Cursor measurements on, for example, a $A \times B$ waveform give a reading in Watts if input A measures (milli)Volts and input B measures (milli)Amperes.



For other cursor measurements on, for example, a $A+B$, $A-B$ or $A \times B$ waveform no reading will be available if the input A and input B measurement unit are different.

Using Cursors on Spectrum Measurements

To do a cursor measurement on a spectrum, do the following:

- 

From Spectrum measurement display the cursor key label.

- 

Move the cursor and observe the readings at the top of the screen.

Making Rise Time Measurements

To measure rise time, do the following:

- | | | |
|---|---------------|-----------------------------------------------------------------------------------------------------|
| 1 | CURSOR | From scope mode, display the cursor key labels. |
| | | |
| 2 | F1 | Press to highlight I |
| 3 | F4 | For multiple waveforms select the required waveform A, B, C, D or M (if a math function is active). |
| 4 | F3 | Select MANUAL or AUTO (this automatically does steps 5 to 7). |
| 5 | | Move the upper cursor to 100% of the waveform height. A marker is shown at 90%. |
| 6 | F2 | Highlight the other cursor. |
| 7 | | Move the lower cursor to 0% of the waveform height. A marker is shown at 10%. |

The reading shows the risetime from 10%-90% of the waveform amplitude.

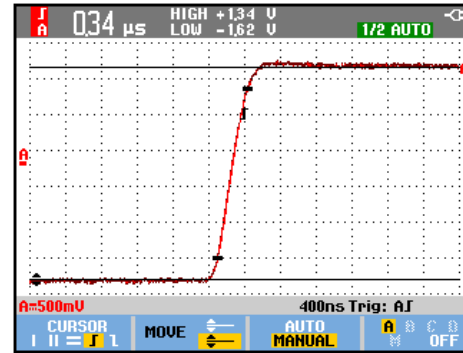

Figure 27. Risetime Measurement

Note

Direct access to Rise time or Fall time with cursors on is possible via the key sequence SCOPE, F2 – READING, and then selection of Rise or Fall time.

Chapter 4

Triggering on Waveforms

About this Chapter

This chapter provides an introduction to the trigger functions of the test tool. Triggering tells the test tool when to begin displaying the waveform. You can use fully automatic triggering, take control of one or more main trigger functions (semi-automatic triggering), or you can use dedicated trigger functions to capture special waveforms.

Following are some typical trigger applications:

- Use the Connect-and-View™ function to have full automatic triggering and instant display of virtually any waveform.
- If the signal is unstable or has a very low frequency, you can control the trigger level, slope, and trigger delay for a better view of the signal. (See next section.)
- For dedicated applications, use one of the four manual trigger functions:
 - Edge triggering
 - Video triggering
 - Pulse Width triggering
 - External Triggering (models 190-xx2 only)

Setting Trigger Level and Slope

The Connect-and-View™ function enables hands-off triggering to display complex unknown signals.

When your test tool is in manual range, do the following:



Perform an auto set. **AUTO** appears at the top right of the screen.

Automatic triggering assures a stable display of virtually any signal.

From this point, you can take over the basic trigger controls such as level, slope and delay. To optimize trigger level and slope manually, do the following:

- | | | |
|---|----------------|------------------------------------------------------------------------------------------------------------------------------------------------------------------------------------|
| 1 | TRIGGER | Display the TRIGGER key labels. |
| | | AUTO TRIG SLOPE AUTO LEVEL TRIGGER
A B C D J L X MANUAL OPTIONS.. |
| 2 | F2 | Trigger on either positive slope or negative slope of the chosen waveform.

In Dual Slope Triggering (X) the test tool triggers on both positive slope and negative slope. |
| 3 | F3 | Enable the arrow keys for manual trigger level adjustment. |

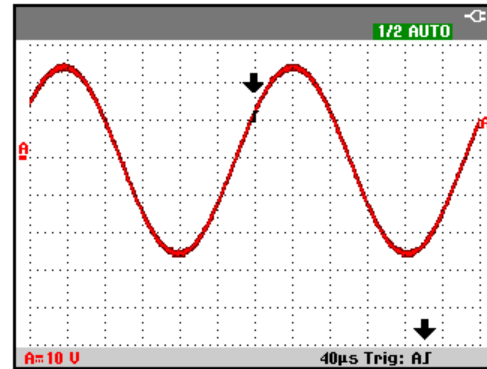

Figure 28. Screen with all Trigger Information

- | | | |
|---|--|---------------------------|
| 4 | | Adjust the trigger level. |
|---|--|---------------------------|

Observe the trigger icon **J** that indicates the trigger position, trigger level, and slope.

At the bottom of the screen the trigger parameters are displayed (See Figure 28). For example, **Trig: AJ** means that input A is used as the trigger source with a positive slope.

When a valid trigger signal is found, the trigger key will be lit and the trigger parameters appear in black.



When no trigger is found, the trigger parameters appear in gray, and the key light will be off.

Using Trigger Delay or Pre-trigger

You can begin to display the waveform some time before or after the trigger point has been detected. Initially, you have a half screen (6 divisions) of pre-trigger view (negative delay).

To set the trigger delay, do the following:

- 5  Hold down to adjust the trigger delay.

Observe that the trigger icon  on the screen moves to show the new trigger position. When the trigger position moves left off of the screen, the trigger icon changes into  to indicate that you have selected a trigger delay. Moving the trigger icon to the right on the display gives you a pre-trigger view. This allows you to see what happened before the trigger event, or what caused the trigger.

In case of a trigger delay, the status at the bottom of the screen will change. For example:

AJ +500.0ms

This means that input A is used as the trigger source with a positive slope. The 500.0 ms indicates the (positive) delay between trigger point and waveform display.

When a valid trigger signal is found, the trigger key will be lit and the trigger parameters appear in black.

When no trigger is found, the trigger parameters appear in gray, and the key light will be off.

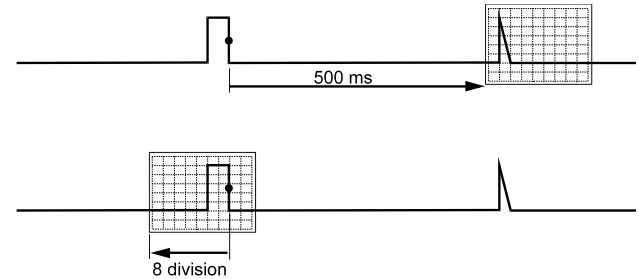



Figure 29. Trigger Delay or Pre-trigger View

Figure 29 shows an example of a trigger delay of 500 ms (top) and an example of pre-trigger view of 8 divisions (bottom).

Automatic Trigger Options

In the trigger menu, settings for automatic triggering can be changed as follows. (See also Chapter 1: “Displaying an Unknown Signal with Connect-and-View”)

- 1  Display the **TRIGGER** key labels.



Note

The **TRIGGER** key labels can differ depending on the latest trigger function used.

- 2  Open the **TRIGGER OPTIONS** menu.

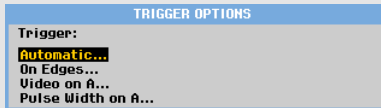

- 3  Open the **AUTOMATIC TRIGGER** menu.



If the frequency range of the automatic triggering is set to > 15 Hz, the Connect-and-View™ function responds more quickly. The response is quicker because the test tool is instructed not to analyze low frequency signal components. However, when you measure frequencies lower than 15 Hz, the test tool must be instructed to analyze low frequency components for automatic triggering:

- 4  Select **> 1 Hz** and return to the measurement screen.

Triggering on Edges

If the signal is unstable or has a very low frequency, use edge triggering to obtain full manual trigger control.

To trigger on rising edges of the input A waveform, do the following:

- 1  Display the **TRIGGER** key labels.

AUTO TRIG	SLOPE	AUTO LEVEL	TRIGGER OPTIONS..
A B C D	J L X	HANDL	
- 2  Open the **TRIGGER OPTIONS** menu.

TRIGGER OPTIONS	
Trigger:	
Automatic...	
On Edges...	
Video on A...	
Pulse Width on A...	
- 3  Open the **TRIGGER ON EDGE** menu.



TRIGGER ON EDGE		
Update:	Trigger Filter:	NCycle:
Free Run	Off	Off
On Trigger	Noise Reject	On
Single Shot	HF Reject	

When **Free Run** is selected, the test tool updates the screen even if there are no triggers. A waveform always appears on the screen.

When **On Trigger** is selected, the test tool needs a trigger to display a waveform. Use this mode if you want to update the screen *only* when valid triggers occur.

When **Single Shot** is selected, the test tool waits for a trigger. After receiving a trigger, the waveform is displayed and the instrument is set to HOLD.

In most cases it is advised to use the Free Run mode:

- 4  Select **Free Run**, jump to **Trigger Filter**.
- 5  Set **Trigger Filter** to **Off**.



Observe that the key labels at the bottom of the screen have adapted to allow further selection of specific edge trigger settings:

EDGE TRIG	SLOPE	LEVEL	TRIGGER OPTIONS..
A B C D	J L X		

Triggering on Noisy Waveforms

To reduce jitter on the screen when triggering on noisy waveforms, you can use a trigger filter. Continue from step 3 of the previous example as follows:

4  Select **On Trigger**, jump to **Trigger Filter**.

5  Set **Noise Reject** or **HF Reject** to **On**. This is indicated by a taller trigger icon .

When **Noise Reject** is on, an increased trigger gap will be applied.

When **HF Reject** is on, HF noise on the (internal) trigger signal will be suppressed.

Making a Single Acquisition

To catch single events, you can perform a **single shot** acquisition (one-time screen update). To set up the test tool for a single shot of the input A waveform, continue from step 3 (page 61) again:

4  Select **Single Shot**.

The word **MANUAL** appears at the top of the screen indicating that the test tool is waiting for a trigger. As soon as the test tool receives a trigger, the waveform is displayed and the instrument is set to hold. This is indicated by the word **HOLD** at top of the screen.

The test tool will now have a screen like Figure 30.

5  Arm the test tool for a new single shot.

Tip

The test tool stores all single shots in the replay memory. Use the Replay function to look at all the stored single shots (see Chapter 3).

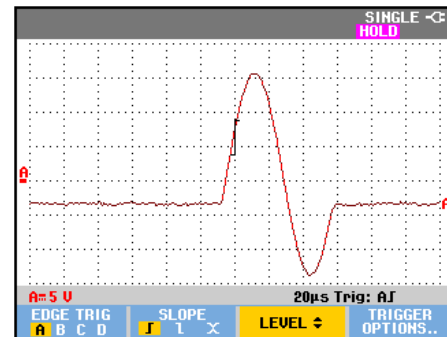





Figure 30. Making a Single Shot Measurement

N-Cycle Triggering

N-Cycle triggering enables you to create a stable picture of for example n-cycle burst waveforms.



Each next trigger is generated after the waveform has crossed the trigger level N times in the direction that complies with the selected trigger slope.

To select N-Cycle triggering, continue from step 3 (page 61) again:

- 4  Select **On Trigger** or **Single Shot**, jump to **Trigger Filter**.
- 5  Select a **Trigger Filter** or set it **Off**.
- 6  Set **NCycle** to **On**.

Observe that the key labels at the bottom of the screen have been changed to allow further selection of specific N-Cycle trigger settings:



- 7  Set the number of cycles N
- 8  Adjust the trigger level

Waveforms with N-Cycle triggering (N=2) and without N-Cycle triggering are shown in Figure 31.

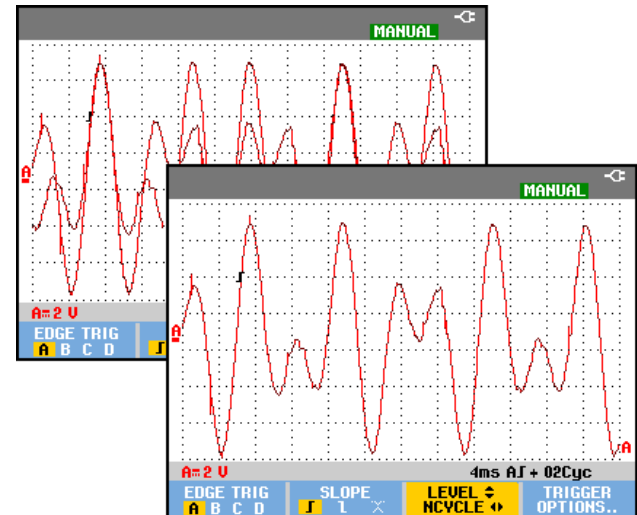



Figure 31. N-Cycle triggering

Triggering on External Waveforms (models 190-xx2)

Use external triggering when you want to display waveforms on inputs A and B while triggering on a third signal. You can choose external triggering with automatic triggering or with edge triggering.

- 1 Supply a signal to the red and black 4-mm banana jack inputs.

In this example you continue from the Trigger on Edges example. To choose the external signal as trigger source, continue as follows:

- 2  Display the **TRIGGER** (On Edges) key labels.



- 3  Select **Ext** (external) edge trigger.

Observe that the key labels at the bottom of the screen have been adapted to allow selection of two different external trigger levels: 0.12 V and 1.2 V:





- 4  Select **1.2V** under the **Ext LEVEL** label.

From this point the trigger level is fixed and is compatible with logic signals.

Triggering on Video Signals

To trigger on a video signal, first select the standard of the video signal you are going to measure:

- 1 Apply a video signal to the red input A.
- 2  Display the **TRIGGER** key labels.

AUTO TRIG	SLOPE	AUTO LEVEL	TRIGGER
A B C D	J L X	MANUAL	OPTIONS..
- 3  Open the **Trigger Options** menu.

TRIGGER OPTIONS	
Trigger:	
Automatic...	
On Edges...	
Video on A...	
Pulse Width on A...	
- 4  Select **Video on A ...** to open the **TRIGGER ON VIDEO** menu.

TRIGGER ON VIDEO	
Polarity:	PAL
Positive	NTSC
Negative	PALPlus
	SECAM
	Non interlaced...
- 5  Select positive signal polarity for video signals with negative going sync pulses.

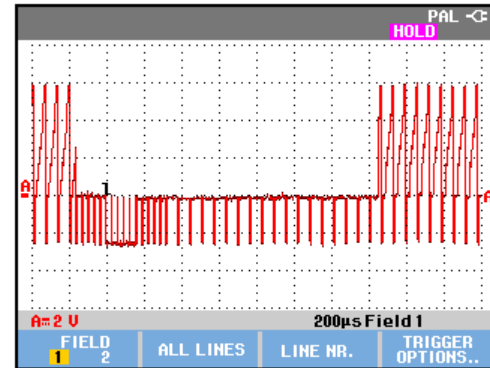



Figure 32. Measuring Interlaced Video Signals

- 6  Select a video standard or **Non interlaced...** and return.

If you select Non interlaced a scan rate selection menu will open.

Trigger level and slope are now fixed.

Observe that the key labels at the bottom of the screen have been changed to allow further selection of specific video trigger settings.

Triggering on Video Frames

Use **FIELD 1** or **FIELD 2** to trigger either on the first half of the frame (odd) or on the second half of the frame (even). To trigger on the second half of the frame, do the following:

7  Choose **FIELD 2**.

The signal part of the even field is displayed on the screen.

Triggering on Video Lines



Use **ALL LINES** to trigger on all line synchronization pulses (horizontal synchronization).

7  Choose **ALL LINES**.

The signal of one line is displayed on the screen. The screen is updated with the signal of the next line immediately after the test tool triggers on the horizontal synchronization pulse.

To view a specific video line in more detail, you can select the line number. For example, to measure on video line 123, continue from step 6 as follows:

7  Enable video line selection.

8   Select number 123.

The signal of line 123 is displayed on the screen. Observe that the status line now also shows the selected line number. The screen is continuously updated with the signal of line 123.

Triggering on Pulses

Use pulse width triggering to isolate and display specific pulses that you can qualify by time, such as glitches, missing pulses, bursts or signal dropouts.

Detecting Narrow Pulses

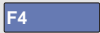

To set the test tool to trigger on narrow positive pulses shorter than 5 ms, do the following:

- Apply a video signal to the red input A.
-  Display the **TRIGGER** key labels.

AUTO TRIG	SLOPE	AUTO LEVEL	TRIGGER
A B C D	↑ ↓ ×	MANUAL ↕	OPTIONS..
-  Open the **TRIGGER OPTIONS** menu.

TRIGGER OPTIONS	
Trigger:	
Automatic...	
On Edges...	
Video on A...	
Pulse Width on A...	
-  Select **Pulse Width on A...** to open the trigger on pulse width menu.



TRIGGER ON PULSE WIDTH		
Pulses:	Condition:	Update:
↑ ↓	<t >t =t (±10%) ≠t (±10%)	On Trigger Single Shot

-  Select the positive pulse icon, then jump to **Condition**.
-  Select <t, then jump to **Update**.
-  Select **On Trigger**.

The test tool is now prepared to trigger on narrow pulses only. Observe that the trigger key labels at the bottom of the screen have been adapted to set the pulse conditions:

JL WIDTH 48.0µs ←	CONDITION >t <t OFF	LEVEL ↕	TRIGGER OPTIONS..
----------------------	------------------------	---------	----------------------

To set the pulse width to 5 ms, do the following:

-  Enable the arrow keys to adjust the pulse width.
-  Select 5 ms.

All narrow positive pulses shorter than 5 ms are now displayed on the screen. (See Figure 33).

Tip

The test tool stores all triggered screens in the replay memory. For example, if you setup your triggering for glitches, you can capture 100 glitches with time stamps. Use the **REPLAY** key to look at all the stored glitches.

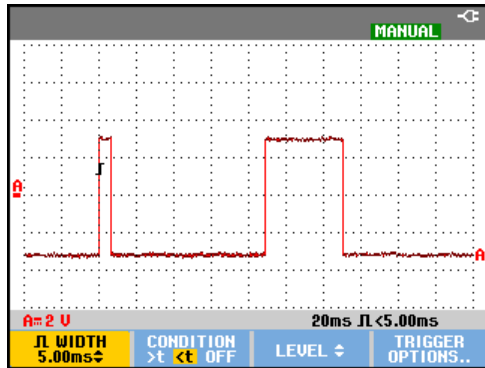

Figure 33. Triggering on Narrow Glitches

Finding Missing Pulses

The next example covers finding missing pulses in a train of positive pulses. In this example it is assumed that the pulses have a 100 ms distance between the rising edges. If the time accidentally increases to 200 ms, a pulse is missing. To set the test tool to trigger on such missing pulses, let it trigger on gaps bigger than about 110 ms.

Do the following:

- 1 **TRIGGER** Display the **TRIGGER** key labels.

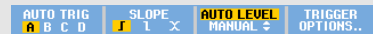

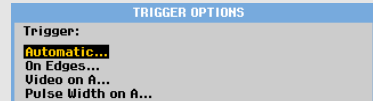

- 2 **F4** Open the **TRIGGER OPTIONS** menu.

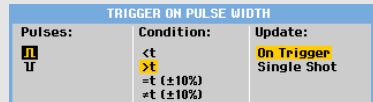

- 3 **ENTER** Select **Pulse Width on A...** to open the **TRIGGER ON PULSE WIDTH** menu.





- 4  Select the positive pulse icon to trigger on a positive pulse, then jump to **Condition:** .
- 5  Select >t, then jump to **Update:** .
- 6  Select **On Trigger** and exit the menu.

The test tool is now prepared to trigger on pulses that are more than a selectable time in duration. Observe that the trigger menu at the bottom of the screen has been adapted to set the pulse condition:



To set the pulse width to 110 ms, continue as follows:

- 7  Enable the arrow keys to adjust the pulse width.
- 8  Select 110 ms.

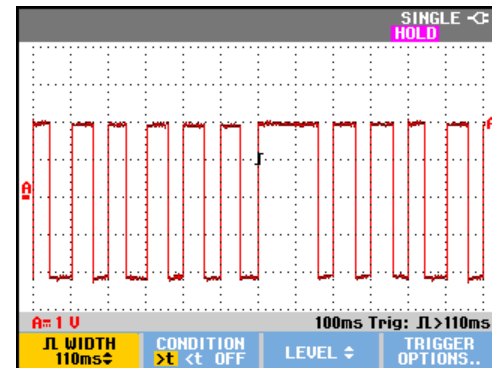

Figure 34. Triggering on Missing Pulses

Using Memory and PC

About this Chapter

This chapter provides a step-by-step introduction to the general functions of the test tool that can be used in the three main modes: Scope, Meter, or Recorder. You will find information on computer communication at the end of this chapter.

Using the USB Ports

The test tool is provided with two USB ports:

- a USB-host port to connect an external flash memory drive ('USB-stick') for data storage.
- a mini-USB-B port which allows you to connect the test tool to a PC for remote control and data transfer under PC-control, see Using FlukeView[®] on page 79.

The ports are fully isolated from the input channels and are covered with dust covers when not in use.

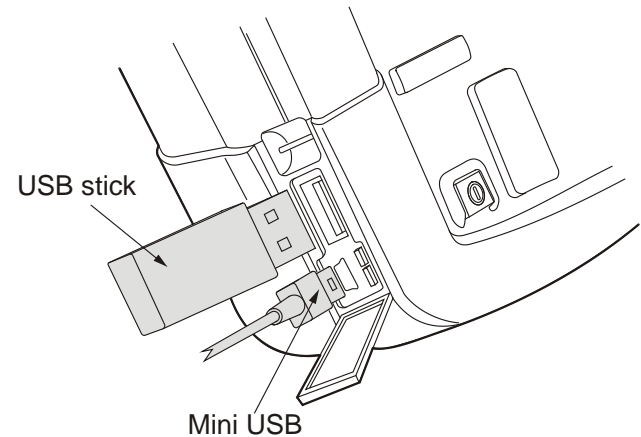

Figure 35. Test Tool USB Connections

Saving and Recalling

You can:

- Save screens and setups to internal memory, and recall them again from memory. The test tool has 30 'screen and setup' memories, 10 'record and setup' memories, and 9 screen image memories. See also
-
- Table 1.
- Save up to 256 screens and setups to a USB memory device, and recall them again from memory.
- Name saved screens and setups according to your own preferences.
- Recall screens and recordings to analyze the screen image at a later date.
- Recall a setup to continue a measurement with the recalled operating configuration.

Notes

Saved data is stored in non-volatile Flash memory.

Not saved instrument data is stored in RAM memory and will be kept at least 30 seconds when the battery is removed when no power is supplied via the BC190 power adapter.

Table 1. Test Tool Internal Memory

Mode	Memory locations		
	30x	10x	9x
METER	Setup + 1 screen	-	Screen image
SCOPE	Setup + 1 screen	Setup + 100 replay screens	Screen image
SCOPE REC	-	Setup + record data	Screen image
TRENDPLOT	-	Setup + trendplot data	Screen image

Notes:

- *In persistence mode, the most recent waveform will be saved, not all waveforms that build the persistence display.*

- In the displayed file list of stored data the following symbols are used:



setup + 1 screen



setup + replay screens/record data



setup + trendplot data





screen image (imagexx.bmp)

- a screen image can be copied to a USB stick connected to the test tool. The USB stick connected to a PC allows you to insert the image for instance into a text document. The copying function is available under SAVE and F4 – File OPTIONS. A screen image can not be recalled on to the screen.

Saving Screens with Associated Setups

To save for example a screen+setup in Scope mode, do the following:

1  Display the **SAVE** key labels.



From this point the screen is frozen.

2  Open the **SAVE** menu.

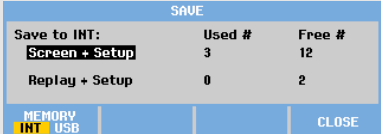

SAVE		
Save to INT:	Used #	Free #
Screen + Setup	3	12
Replay + Setup	0	2

MEMORY INT USB CLOSE

Observe the number of available and used memory locations.

In METER mode the **SAVE AS** menu will be shown now as only a setup+screen can be saved, see step 4.

3

F1

Select the target memory INT (internal memory) or USB (USB device).

Observe the new **SAVE** menu if you select USB.

SAVE			
Save to USB:	Used #	Used kB	Free kB
Screen + Setup	2	529	
Replay + Setup	3	876	125720
Data as .CSV to USB	7	11200	
MEMORY			
INT	USB		CLOSE

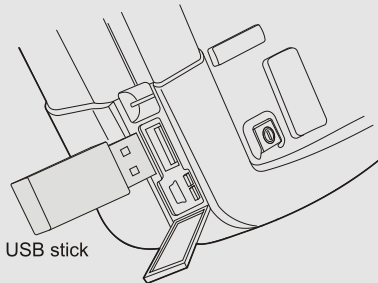

You can save data in .csv format to a USB stick. The saved .csv file can be used to analyze the data in e.g. FlukeView® ScopeMeter® or in Excel.

4



Select **Screen+Setup** and open the **SAVE AS** menu.



Below Save As: the default name + serial number and OK SAVE are already selected.

To modify the name for this particular Screen+Setup or to modify the default name see below '**Editing Names**'.

5



Save the Screen+setup.



To resume your measurements press

All memories in use

If no free memory locations are available a message pops up that proposes to you to overwrite the oldest data set. Do one of the following:

If you don't want to overwrite the oldest data set,





- press **F3**, the delete one or more memory locations, and save again.

If you want to overwrite the oldest data set,

- press **F4**.

Editing names

To name the screen+setup according to your own preferences, continue from step 4 as follows:

5		Open the EDIT NAME menu.
6		Skip to a new character position.
7		Select another character and press ENTER to accept your choice. Repeat 6 and 7 until done.
8		Accept the name and return to the SAVE AS menu.

9



Highlight **OK SAVE** to save the actual screen using the edited name.

To modify the default name generated by the test tool, continue from step 8 as follows:

9



Highlight **SET DEFAULT** to save the new default name.

10



Highlight **OK SAVE** to save the actual screen using the new default name.



Notes

The 'record+setup' memory locations store more than just what is visible on the screen. In TrendPlot or Scope Record mode the full recording is saved. In scope mode you can save all 100 replay screens in a single record+setup memory location. The table below shows what you can store for the various test tool modes.

*To save a TrendPlot press **STOP** first.*

Saving Screens in .bmp Format (Print Screen)



To save a screen in bitmap (.bmp) format, do the following:

1		Display the SAVE key labels.
		
2		Save the screen to: <ul style="list-style-type: none">– Internal memory (INT) if no USB device is connected.– a USB device if connected.

The file is saved using a fixed name (IMAGE) and a serial number, for example IMAGE004.bmp.









If no free memory locations are available a message pops up that proposes to you to overwrite the oldest data set. Do one of the following:

If you don't want to overwrite the oldest data set,

- press , then delete one or more memory locations, and save again.
- If you want to overwrite the oldest data set,
- press .









Deleting Screens with Associated Setups

To delete a screen and associated setup, do the following:

1		Display the SAVE key labels.
		
2		Open the FILE OPTIONS menu.
3		Select the source, internal memory (INT) or a USB device.
4		Highlight DELETE ,
5		Accept your choice and jump to the filename field
6		Select the file to be deleted, Or
		Select all files for deletion.
7		Delete the selected files.

Recalling Screens with Associated Setups

To recall a screen+setup, do the following:









1		Display the SAVE key labels.
		
2		Open the RECALL menu.
3		Select the source, internal memory (INT) or a USB device.
4		Highlight DATA .
5		Accept your choice and jump to the filename field
6		Select the file to be recalled.
7		Recall the selected screen+setup.

Observe that the recalled waveform is displayed and that **HOLD** appears on the screen. From this point you can use cursors and zoom for analysis or you can print the recalled screen.

To recall a screen as a reference waveform to compare it to an actually measured waveform, see Chapter 1 'Comparing Waveforms'.

Recalling a Setup Configuration











To recall a setup configuration, do the following:

1		Display the SAVE key labels.
		
2		Open the RECALL menu.
3		Select the source, internal memory (INT) or a USB device.
4		Highlight setup .
5		Accept your choice and jump to the filename field.
6		Select the file to be recalled,
7		Recall the selected setup.

From this point you continue in the new operating configuration.

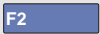
Viewing Stored Screens

To scroll through the memories while looking at the stored screens, do the following:







1		Display the SAVE key labels.
		
2		Open the RECALL menu.
3		Select the source, internal memory (INT) or a USB device.
4		Jump to the filename field.
5		Highlight a file.
6		View the screen, and open the viewer.
		
7		Scroll through all stored screens.
8		Save the screen to USB device (if connected) or internal memory.
9		Exit the View mode.





Note:

In the VIEW mode the replay screens of a saved 'record+setup' cannot be viewed! Only the screen at the instant of saving can be reviewed in this way. To see all replay screens recall them from memory using the RECALL option.

Renaming Stored Screens and Setup Files

To modify the name of stored files, do the following:





1		Display the SAVE key labels.
		
2		Open the FILE OPTIONS menu.
3		Select the source, internal memory (INT) or a USB device.
4		Highlight RENAME .
5		Accept your choice and jump to the filename field.
6		Highlight the file to be renamed.





7		Open the RENAME menu.
8		Skip to a new character position.
9		Select another character. Repeat 8 and 9 until done.
10		Accept the name and return to the RENAME menu.

Copying-Moving Stored Screens and Setup Files

You can copy or move a file from internal memory to a USB device or from a USB device to internal memory.

To copy or to move a file, do the following:

1		Display the SAVE key labels.
		
2		Open the FILE OPTIONS menu.
3		Select the source, internal memory (INT) or a USB device. The other memory will become the destination.

4		Highlight COPY to copy or MOVE to move (copy and delete source) a file.
5		Accept your choice and jump to the filename field.
6		Select the file to be copied or moved, Or Select all files
		
7		Copy or delete the selected files.

Using FlukeView®

With the FlukeView® software you can upload waveform data and screen bitmaps to your PC or notebook computer for further processing.

USB drivers for the test tool and a FlukeView® Demo version with restricted functionality are available on the CD-ROM included in the shipment.

Connecting to a Computer

To connect the test tool to a PC or notebook computer and use the FlukeView software for Windows® (SW90W), do the following:

- Use a USB-A to mini-USB-B interface cable to connect a computer to the mini USB PORT of the test tool (See Figure 36).
- Install the test tool USB drivers, see Appendix A.
- Install the FlukeView® Demo version. For information about installing and using the FlukeView® ScopeMeter® software see the FlukeView® Users Manual on the CD ROM.

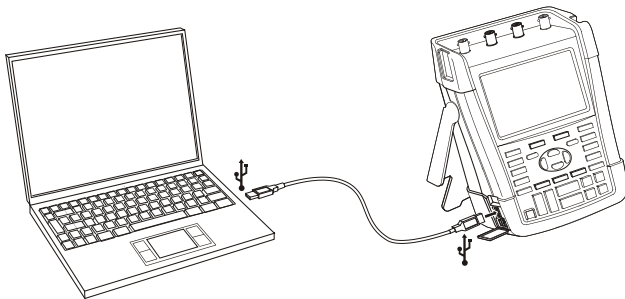

Figure 36. Connecting a Computer

Notes

- *The optional kit SCC290 contains an activation code to convert the FlukeView® Demo version into a fully operational version.*
- *A complete FlukeView® version can be ordered using ordering code SW90W. For use with the Fluke Series II ScopeMeter® test tools FlukeView® ScopeMeter® release V5.1 or higher is required.*
- *The test tool input channels are electrically isolated from the USB port.*
- *Remote control and data transfer via mini-USB is not possible while saving or recalling data to or from the USB-stick.*

Chapter 6

Tips

About this Chapter

This chapter gives you information and tips on how you can make the best use of the test tool.

Using the Standard Accessories

The following illustrations show the use of the standard accessories such as voltage probes, test leads, and the various clips.

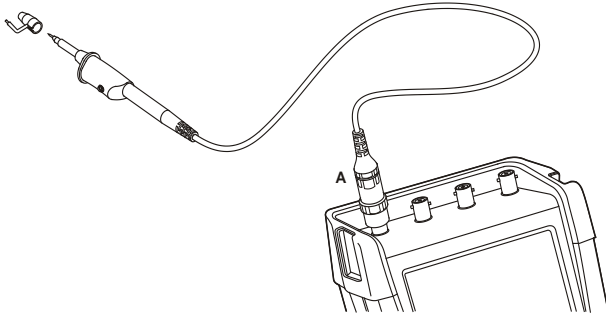

Figure 37. HF Voltage Probe Connection Using Ground Spring

Warning

To avoid electrical shock or fire, do not connect the ground spring to voltages higher than 30 Vrms from earth ground.

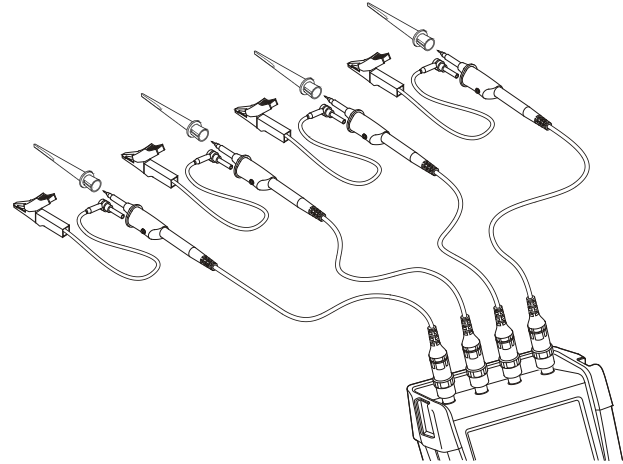

Figure 38. Electronic Connections for Measurements Using Hook Clips and Alligator Clip Grounding

⚠⚠ Warning

To avoid electrical shock, re-apply the insulation sleeve (Figure 1, item e) over the probe tip when the hook clip is not used. This also avoids the risk of accidentally interconnecting the reference contact of multiple probes when groundleads are connected or avoids short-circuiting any circuitry via the bare ground ring of the probe..

Using the Independently Floating Isolated Inputs

You can use the independently floating isolated inputs to measure signals that are independently floating from each other.

Independently floating isolated inputs offer additional safety and measurement capabilities compared to inputs with common references or grounds.

Measuring Using Independently Floating Isolated Inputs

The test tool has independently floating isolated inputs. Each input section (A, B, C, D – A, B, METER INPUT) has its own signal input and its own reference input. The reference input of each input section is electrically isolated from the reference inputs of the other input sections. The isolated input architecture makes the test tool about as versatile as having four independent instruments. The advantages of having independently floating isolated inputs are:

- It allows simultaneous measurement of independently floating signals.

- Additional safety. Since the commons are not directly connected, the chance of causing short circuit when measuring multiple signals is greatly reduced.
- Additional safety. When measuring in systems with multiple grounds, the ground currents induced are kept to a minimum.

Because the references are not connected together inside the test tool, each reference of the used inputs must be connected to a reference voltage.

Independently floating isolated inputs are still coupled by parasitic capacitance. This can occur between the input references and the environment, and between the input references mutually (see Figure 39). For this reason, you should connect the references to a system ground or another stable voltage. If the reference of an input is connected to a high speed and / or high voltage signal, you should be aware of parasitic capacitance. (See Figure 39, Figure 41, Figure 42 and Figure 43.)

Note

The input channels are electrically isolated from the USB port and from the power adapter input.

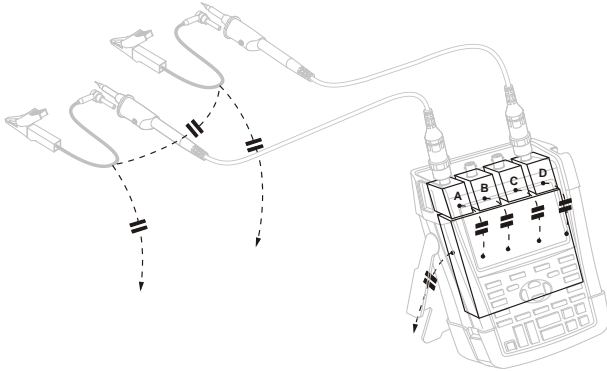

Figure 39. Parasitic capacitance between probes, instrument and environment

Note:

Parasitic capacitances such as shown in Figure 39, 41 and 43 can cause ringing on the signal. Ringing can be limited by adding a ferrite bead around the probe cable.

Warning

To avoid electrical shock, always use the insulation sleeve (Figure 1, item e) or the hook clip when using the probe reference (ground) lead. The voltage applied to the reference lead is also present on the ground ring near the probe tip as shown in Figure 40. The isolation sleeve avoids the risk of accidentally interconnecting the reference contact of multiple probes when groundleads are connected or short-circuiting any circuitry via the bare ground ring..

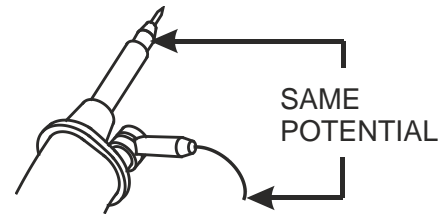

Figure 40. Probe Tip

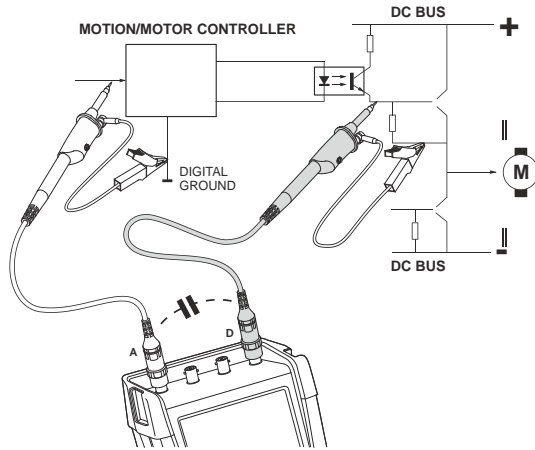

Figure 41. Parasitic capacitance between analog and digital reference

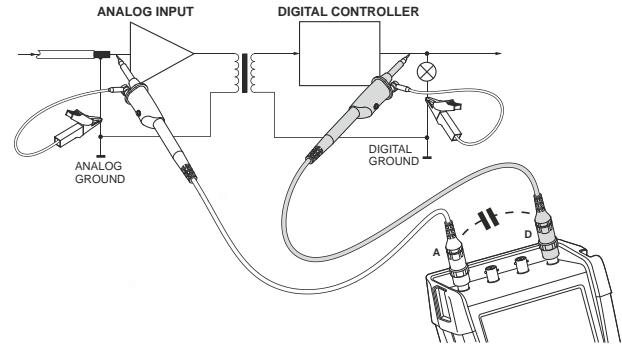

Figure 42. Correct connection of reference leads

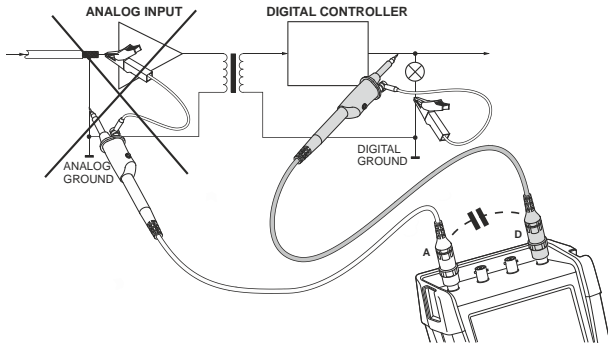

Figure 43. Wrong connection of reference leads

Noise that is picked up by reference lead D can be transmitted by parasitic capacitance to the analog input amplifier.

Using the Tilt Stand

The test tool is equipped with a tilt stand, allowing viewing from an angle while placed on a table. The typical position is shown in Figure 44.

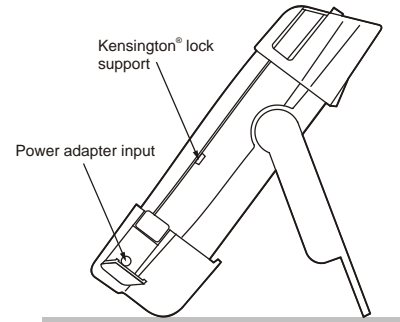

Figure 44. Using the Tilt Stand

Note

An optional Hanging Hook, ordering code HH290, can be attached to the rear of the test tool. The hook enables you to hang the test tool at a convenient viewing position, for example a cabinet door or a separation wall.

Kensington®-lock

The test tool is provided with a security slot compatible with a Kensington® lock, see Figure 44.

The Kensington Security Slot along with a locking cable provides physical security against thefts of opportunity. Locking cables can be obtained from, for example, laptop computer accessory dealers.

Fixing the Hangstrap

A hang strap is supplied with the test tool. The figure below shows how to attach the strap correctly to the test tool.

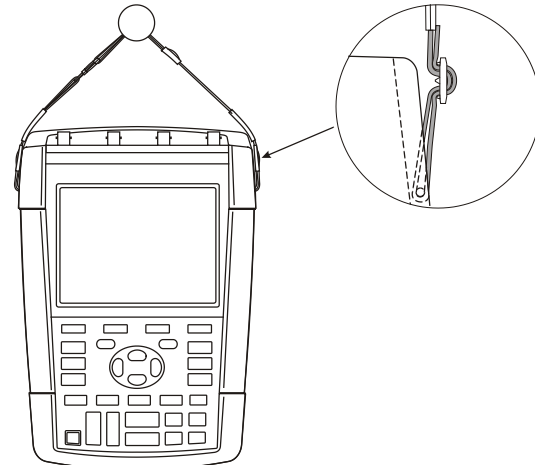

Figure 45. Fixing the Hangstrap

Resetting the Test Tool

If you want to reset the test tool to the factory settings, without clearing the memories, do the following:

1  Turn the test tool off.

2  Press and hold.

3  Press and release.

The test tool turns on, and you should hear a double beep, indicating the reset was successful.

4  Release.

Suppressing Key Labels and Menu's

You can close a menu or hide key label at any time:



Hide any key label, press again to display the key label again (toggle function).







A displayed menu will be closed.

To display menus or key labels, press one of the yellow menu keys, e.g. the **SCOPE** key.

You can also close a menu using the  softkey **CLOSE**.

Changing the Information Language

During operation of the test tool, messages may appear at the bottom of the screen. You can select the language in which these messages are displayed. In this example you can select English or French. To change the language from English to French, do the following:





1		Display the USER key labels.
		
2		Open the LANGUAGE SELECT menu.
		
3		Highlight FRENCH .
4		Accept French as the language.

Note

The languages available in your test tool may differ from this example.

Adjusting the Contrast and Brightness

To adjust the contrast and backlight brightness, do the following:

1		Display the USER key labels.
		
2		Enable the arrow keys for manual contrast and backlight adjustment.
3		Adjust the contrast of the screen.
4		Change the backlight.

Note

The new contrast and brightness are stored until a new adjustment is made.

To save battery power, the test tool is in economic brightness mode when operated on the battery. The high brightness intensity increases when you connect the power adapter.

Note

Using dimmed light lengthens battery power operating time. See Chapter 8 'Specifications', section 'Miscellaneous'.

Changing Date and Time

The test tool has a date and time clock. For example, to change the date to 19 April, 2013, do the following:

1  Display the **USER** key labels.







2  Open the **USER OPTIONS** menu.



3  Open the **DATE ADJUST** menu.



- 4  Choose 2013, jump to **Month:** .
- 5  Choose 04, jump to **Day:** .
- 6  Choose 19, jump to **Format:** .
- 7  Choose **DD/MM/YY**, accept the new date.

You can change the time in a similar way by opening the **Time Adjust...** menu (steps 2 and 3.)

Saving Battery Life

When operated on the battery, the test tool conserves power by shutting itself down. If you have not pressed a key for at least 30 minutes, the test tool turns itself off automatically.

Automatic power shutdown will not occur if TrendPlot or Scope Record is on, but the backlight will dim. Recording will continue even if the battery is low, and retention of memories is not jeopardized.

To save battery life without automatic power shutdown you can use the display AUTO-off option. The display will be turned off after the selected time (30 seconds or 5 minutes).



Note



If the power adapter is connected, there is no automatic power shutdown, and the display AUTO-off function is inactive.



Setting the Power Down Timer

Initially the power shutdown time is 30 minutes. You can set the power shutdown time to 5 minutes as following:

- 1**  Display the **USER** key labels.







- 2**  Open the **USER OPTIONS** menu.

- 3**  Open the **BATTERY SAVE OPTIONS** menu.

- 4**  Select **Instrument Auto-OFF 5 Minutes**.

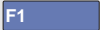
Setting the Display AUTO-off Timer

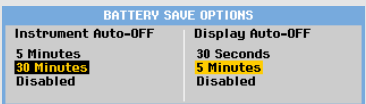
Initially the display AUTO-off timer is disabled (no automatic display turn off). You can set the display AUTO-off timer to 30 seconds or to 5 minutes as following:

-  Display the **USER** key labels.

-  Open the **USER OPTIONS** menu.

-  Open the **BATTERY SAVE OPTIONS** menu.

-  Select **Display Auto-OFF 30 Seconds** or **5 Minutes**.

The display will be turned off after the selected time is elapsed.

To turn on the display again do one of the following:

- Press any key. The Display will be visible again and the Display Auto-Off timer starts again. The display will be turned off again when the time has elapsed.
- Connect the power adapter; the Auto-Off timer is inactive now.

Changing the Auto Set Options

With the next procedure you can choose how auto set behaves when you press the **AUTO-MANUAL** (auto set) key.

1  Display the **USER** key labels.



2  Open the **USER OPTIONS** menu.



3  Open the **AUTO SET ADJUST** menu.

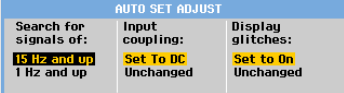

If the frequency range is set to > 15 Hz, the Connect-and-View function responds more quickly. The response is quicker because the test tool is instructed not to analyze low frequency signal components. However, when you measure frequencies lower than 15 Hz, the test tool must be instructed to analyze low frequency components for automatic triggering:

4  Select **1 Hz and up**, then jump to **Input Coupling**:

When you press the **AUTO-MANUAL** (auto set) key, the input coupling can either be set to dc or left unchanged:

5  Select **Unchanged**.

When you press the **AUTO-MANUAL** (auto set) key glitch capture can either be set to On or left unchanged:

6  Select **Unchanged**.

Note

The auto set option for the signal frequency is similar to the automatic trigger option for the signal frequency. (See Chapter 4: “Automatic Trigger Options”). However, the auto set option determines the behavior of the auto set function and shows only effect when you press the auto set key.

Chapter 7

Maintaining the Test Tool

About this Chapter

This chapter covers basic maintenance procedures that can be performed by the user. For complete service, disassembly, repair, and calibration information, see the Service Manual. (www.fluke.com)

Warning

- **Have an approved technician repair the product.**
- **Use only specified replacement parts.**
- **Before carrying out any maintenance, carefully read the safety information at the beginning of this manual.**

Cleaning the Test Tool

Warning

Remove the input signals before you clean the test tool.







Clean the test tool with a damp cloth and a mild soap. Do not use abrasives, solvents, or alcohol. These may damage the text on the test tool.

Storing the Test Tool

If you are storing the test tool for an extended period of time, charge the Li-ion (Lithium-ion) batteries before storing.

Charging the Batteries

At delivery, the Li-ion batteries may be empty and must be charged for 5 hours (with the test tool turned off) to reach full charge.

When battery power is used, the battery indicator at the top of the screen informs you about the condition of the batteries. The battery symbols are:      . The symbol  indicates that there are typically five minutes of operating time left. See also Displaying Battery Information on page 101.

To charge the batteries and power the instrument, connect the power adapter as shown in Figure 46. To charge the batteries more quickly, turn off the test tool.

Caution

To avoid overheating of the batteries during charging, do not exceed the allowable ambient temperature given in the specifications.

Note

No damage will occur if the power adapter is connected for long periods, e.g., during the weekend. The instrument then automatically switches to trickle charging.

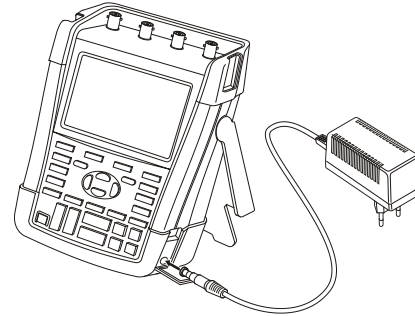

Figure 46. Charging the Batteries

Alternatively, you may choose to exchange the battery (Fluke accessory BP290 or BP291) with a fully charged one, and use the external battery charger EBC290 (optional Fluke accessory).

Replacing the Battery Pack

Warning

Use only the Fluke BP290 (not recommended for 190-xx4) or BP291 for replacement!

When no adapter power is supplied, data not yet saved in the test tool memory is maintained if the battery is replaced within 30 seconds. To avoid loss of data, do one of the following actions before removing the battery:

- Store the data in the test tool's non volatile flash memory, on a computer or a USB stick.
- Connect the power adapter.

To replace the battery pack, proceed as follows:

1. Remove all probes and/or test leads
2. Remove the standup or fold it to the test tool
3. Unlock the battery cover (Figure 47)
4. Lift the battery cover and remove it, (Figure 48)
5. Lift one side of the battery and remove it (Figure 49)
6. Install a battery and close the battery cover.

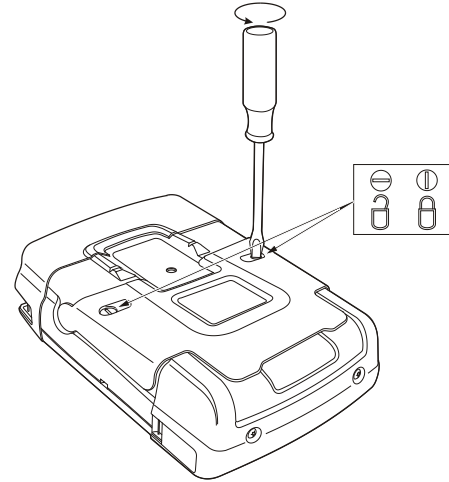

Figure 47. Unlocking the Battery Cover

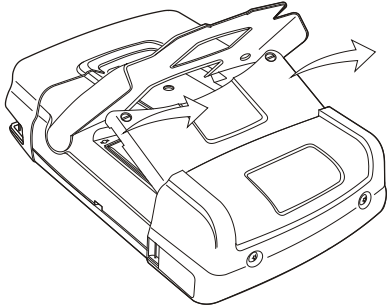

Figure 48. Removing the Battery Cover

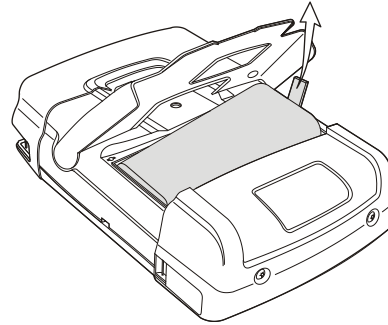

Figure 49. Removing the Battery

Calibrating the Voltage Probes

To fully meet user specifications, you need to adjust the voltage probes for optimal response. The calibration consists of a high frequency adjustment and a dc calibration for 10:1 probes and 100:1 probes. The probe calibration matches the probe to the input channel.

This example shows how to calibrate the 10:1 voltage probes:

1 **A** Display the input A key labels.

INPUT A ON OFF	COUPLING DC AC	PROBE A 1:1...	INPUT A OPTIONS...
-------------------	-------------------	-------------------	-----------------------

2 **F3** Open the PROBE ON A menu.

PROBE ON A		
Probe Type:	Attenuation:	
Voltage	10:1	20:1
Current	10:1	200:1
Temp	100:1	
	1000:1	

PROBE CAL... CLOSE

If the correct probe type is already selected (yellow shaded) you can continue at step 5.

3 **ENTER** Select **Probe Type: Voltage**, and **Attenuation: 10:1**.

4 **F3** Open the PROBE ON A menu again.

5 **F1** Select PROBE CAL...

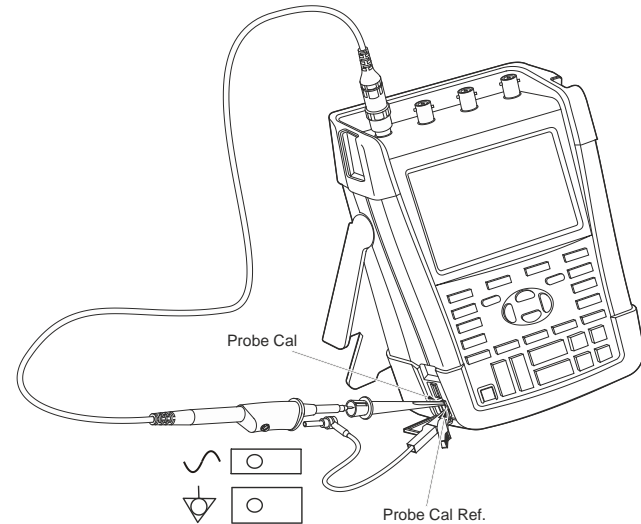

Figure 50. Adjusting Voltage Probes

Note

it is necessary to connect both the hook clip and the zero reference contact.

A message appears asking you whether to start the 10:1 probe calibration.

6 **F4** Start the probe calibration.

A message appears telling you how to connect the probe. Connect the red 10:1 voltage probe to input A and to the probe calibration reference signal as shown in Figure 50.

7 Adjust the trimmer screw in the probe housing until a pure square wave is displayed.

For instructions to access the trimmer screw in the probe housing see the probe instruction sheet.

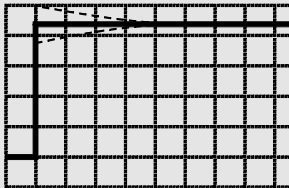

8 **F4** Continue with DC calibration. Automatic DC calibration is only possible for 10:1 voltage probes.

The test tool automatically calibrates itself to the probe. During calibration you should not touch the probe. A message indicates when the DC calibration has completed successfully.

9 **F4** Return.

Repeat the procedure for the blue 10:1 voltage probe on input B, the gray 10:1 voltage probe on input C and the green 10:1 voltage probe on input D.

Note

When using 100:1 voltage probes, choose 100:1 attenuation to perform an adjustment.

Displaying Version and Calibration Information

You can display version number and calibration date:

1 **USER** Display the **USER** key labels.

2 **F3** Open the **VERSION & CALIBRATION** screen.

VERSION & CALIBRATION	
Model Number :	190-294
Serial Number :	19985296
Software Version:	000.00
Options:	None
Calibration Number:	#0
Calibration Date:	01/01/2010

3 **F4** Close the screen.

The screen gives you information about the model number with software version, the serial number, the calibration number with latest calibration date, and installed (software) options.

The test tool specifications (see Chapter 8) are based on a 1 year calibration cycle.

Recalibration must be carried out by qualified personnel. Contact your local Fluke representative for recalibration.

Displaying Battery Information

The battery information screen provides information about the batterystatus and battery serial number.

To display the screen proceed from step 2 in the previous section as follows:

3 **F1** Open the **BATTERY INFORMATION** menu.

BATTERY INFORMATION	
Level:	41% of total
Status:	Discharging
Time to Empty:	176 Minutes
Total Capacity:	4800 mAh
Battery Serial Number:	230

4 **F4** Return to the previous screen.

'Level' indicates the available battery capacity as a percentage of the present maximum battery capacity.



'Time to Empty' indicates a calculated estimate for the remaining operating time.

Parts and Accessories

The following tables list the user-replaceable parts and specific optional accessories for the various test tool models. For more optional accessories, see www.fluke.com.

To order replacement parts or additional accessories, contact your Fluke representative.

Replacement Parts

Item	Ordering Code
<p>Power Adapter available models:</p> <ul style="list-style-type: none"> Universal Europe 230 V, 50 and 60 Hz North America 120 V, 50 and 60 Hz  United Kingdom 240 V, 50 and 60 Hz Japan 100 V, 50 and 60 Hz Australia 240 V, 50 and 60 Hz Universal 115 V/230 V, 50 and 60 Hz *  <p><i>* UL listing applies to BC190/808 and BC190/820 with UL listed line plug adapter for North America.</i></p> <p><i>The 230 V rating of the BC190/808 and BC190/820 are not for use in North America.</i></p> <p><i>For other countries, a line plug adapter complying with the applicable National Requirements must be used.</i></p>	<ul style="list-style-type: none"> BC190/801 BC190/813 BC190/804 BC190/806 BC190/807 BC190/808 BC190/820
<p>Test Leads with test pins (one red, one black)</p>	<p>TL175</p>



Replacement Parts (continued)

<p>Voltage Probe Set (Red or Blue or Gray or Green)</p> <p>The set includes the following items (not available separately):</p> <ul style="list-style-type: none"> • 10:1 Voltage Probe, 500 MHz (red or blue) • Hook Clip for Probe Tip (black) • Ground Lead with Mini Alligator Clip (black) • Ground Spring for Probe Tip (black) • Insulation Sleeve (black) <p><i>See Figure 1 on page 2 for item reference.</i></p> <p><i>See the VPS410-II instruction sheet for voltage/CAT ratings.</i></p>	<p>VPS410-II-R (red)</p> <p>VPS410-II-B (blue)</p> <p>VPS410-II-G (gray)</p> <p>VPS410-II-V (green)</p>
----------------------------------------------------------------------------------------------------------------------------------------------------------------------------------------------------------------------------------------------------------------------------------------------------------------------------------------------------------------------------------------------------------------------------------------------------------------------------------------------------------------------------------------------------------	---------------------------------------------------------------------------------------------------------

Replacement Parts (continued)

<p>Replacement Set for Voltage Probe VPS410 and VPS410-II </p> <p>The set includes the following items (not available separately):</p> <ul style="list-style-type: none"> • 1x Hook Clip for Probe Tip (black) • 1x Ground Lead with Mini Alligator Clip (black) • 2x Ground Spring for Probe Tip (black) • 2x Insulation Sleeve for Probe Tip (black) <p><i>See Figure 1 on page 2 for item reference.</i></p> <p><i>See the VPS410 instruction sheet for voltage/CAT ratings.</i></p>	<p>RS400</p>
<p>BNC Feedthrough 50 Ohm (1 Watt) terminator (set of two pieces, black)</p>	<p>TRM50</p>
<p>Li-ion battery (26 Wh, not recommended for models 190-xx4)</p>	<p>BP290</p>
<p>Li-ion battery (52 Wh)</p>	<p>BP291</p>
<p>Hangstrap</p>	<p>946769</p>

Optional Accessories

Item	Ordering Code
<p>Voltage Probe Set, designed for use with the Fluke 190-50x test tool. </p> <p>The set includes the following items (not available separately):</p> <ul style="list-style-type: none"> • 10:1 Voltage Probe, 500 MHz (red or blue or gray or green) • Hook Clip for Probe Tip (black) • Ground Lead with Mini Alligator Clip (black) • Ground Spring for Probe Tip (black) • Insulation Sleeve (black) • Probe Tip to BNC Adapter 	<p>VPS510-R (red) VPS510-B (blue) VPS510-G (gray) VPS510-V (green)</p>
<p>Replacement Set for Voltage Probe VPS510 </p> <p>The set includes the following items (not available separately):</p> <ul style="list-style-type: none"> • 1x Hook Clip for Probe Tip (black) • 1x Ground Lead with Mini Alligator Clip (black) • 2x Ground Spring for Probe Tip (black) • 2x Insulation Sleeve for Probe Tip (black) • 2x Probe Tip to BNC Adapter 	<p>RS500</p>

Optional accessories (continued)



<p>Probe Accessory Extension Set – VPS410, VPS410-II </p> <p>The set includes the following items (not available separately):</p> <ul style="list-style-type: none"> • 1x Industrial Alligator for Probe Tip (black) • 1x 2-mm Test Probe for Probe Tip (black) • 1x 4-mm Test Probe for Probe Tip (black) • 1x Industrial Alligator for 4 mm Banana Jack (black) • 1x Ground Lead with 4-mm Banana Jack (black) 	<p>AS400</p>
<p>Software & Carrying Case Kit.</p> <p>Set contains the following parts:</p> <ul style="list-style-type: none"> • FlukeView Software activation key, to convert the FlukeView demo version into an operational version. • Hard Shell Carrying Case C290 	<p>SCC290</p>
<p>FlukeView® ScopeMeter® Software for Windows® (full version)</p>	<p>SW90W</p>
<p>Hard Shell Carrying Case</p>	<p>C290</p>
<p>External Battery Charger, charges BP290/BP291 externally using BC190</p>	<p>EBC290</p>
<p>High Working Voltage Ruggedized Probe, 100:1, (available in 4 colors), 150 MHz, category rating 1000V CAT III / 600V CAT IV, working voltage (between probe tip and reference lead) 2000V in a CAT III environment/ 1200V in a CAT IV environment.</p>	<p>VPS420-R (red) VPS420-B (blue) VPS420-G (gray) VPS420-V (green)</p>

Optional accessories (continued)



Hanging Hook; allows the test tool to be hung on a cabinet door or separation wall.	HH290
50 Ohm Coaxial Cable Set; includes 3 cables (1 red, 1 gray, 1 black), 1.5 m length with safety designed insulated BNC connectors.	PM9091
50 Ohm Coaxial Cable Set; includes 3 cables (1 red, 1 gray, 1 black), 0.5 m length with safety designed insulated BNC connectors.	PM9092
Safety designed BNC T-piece, Male BNC to dual female BNC (fully isolated).	PM9093
BNC Feedthrough 50 Ohm (1 W) terminator (set of two pieces, black)	TRM50
10:1 200 MHz voltage probe, 2.5 m.	VPS212-R (red), VPS212-G (gray)
1:1 30 MHz voltage probe, 1.2 m.	VPS101
Dual Banana Plug male to female BNC	PM9081
Dual Banana Jack female to male BNC	PM9082
Automotive Troubleshooting Kit	SCC298
Service Kit Meter and Drive Applications	SKMD001

Troubleshooting

The Test Tool Shuts Down After a Short Time

- The batteries may be empty. Check the battery symbol at the top right of the screen. A  symbol indicates that the batteries are empty and must be recharged. Connect the BC190 power adapter.
- The test tool is still on but the 'display auto off' timer is active, see Chapter 6 'Setting the Display AUTO-off Timer'. To turn the display on press any key (restarts the 'display AUTO-off' timer), or connect the BC190 power adapter.
- The power down timer is active, see Chapter 6 'Setting the Power Down timer'.
Press  to turn the test tool on.

The Screen Remains Black

- Make sure that the test tool is on (press 
- You might have a problem with the screen contrast. Press  , then press  . Now you can use the arrow keys to adjust the contrast.

- The display 'auto off' timer is active, see Chapter 6 'Setting the Display AUTO-off Timer'. To turn the display on press any key (restarts the 'display AUTO-off' timer), or connect the BC190 power adapter.

The Test Tool Cannot Be Turned Off

If the test tool cannot be turned off due to a software hangup, do the following:

- Keep the ON/OFF key pressed for at least 5 seconds.

FlukeView® Does Not Recognize The Test Tool

- Make sure that the test tool is turned on.
- Make sure that the interface cable is properly connected between the test tool and the PC. Use only the test tool mini USB port for communication with a computer!
- Make sure that no SAVE/RECAL/COPY/MOVE action from or to a USB-stick is being performed.
- Make sure that the USB drivers have been correctly installed, see Appendix A.

Battery Operated Fluke Accessories Do Not Function

- When using battery operated Fluke accessories, always first check the battery condition of the accessory with a Fluke multimeter or follow the procedure given for that particular accessory.

Chapter 8

Specifications

Introduction

Performance Characteristics

FLUKE guarantees the properties expressed in numerical values with the stated tolerance. Specified non-tolerance numerical values indicate those that could be nominally expected from the mean of a range of identical ScopeMeter® test tools.

The Test Tool meets the specified accuracy 30 minutes and two complete acquisitions after power on. Specifications are based on a 1-year calibration cycle.

Environmental Data

The environmental data mentioned in this manual are based on the results of the manufacturer's verification procedures.

Safety Characteristics

The test tool has been designed and tested in accordance with Standards EN/IEC 61010-1, EN/IEC 61010-2-030, EN/IEC 61010-31, Safety Requirements for Electrical Equipment for Measurement, Control, and Laboratory Use.

This manual contains information and warnings that must be followed by the user to ensure safe operation and to keep the instrument in a safe condition. Use of this equipment in a manner not specified by the manufacturer may impair protection provided by the equipment.

Oscilloscope

Isolated Inputs A,B, C and D (Vertical)

Number of Channels

Fluke 190-xx2	2 (A, B)
Fluke 190-xx4	4 (A,B,C,D)

Bandwidth, DC Coupled

FLUKE 190-50x	500 MHz (-3 dB)
FLUKE 190-2xx	200 MHz (-3 dB)
FLUKE 190-1xx	100 MHz (-3 dB)
FLUKE 190-062	60 MHz (-3 dB)

Lower Frequency Limit, AC Coupled

with 10:1 probe	<2 Hz (-3 dB)
direct (1:1)	<5 Hz (-3 dB)

Rise Time

FLUKE 190-50x	0.7 ns
FLUKE 190-2xx	1.7 ns
FLUKE 190-1xx	3.5 ns
FLUKE 190-062	5.8 ns

Analog Bandwidth Limiters20 MHz and 10 kHz

Input Coupling.....AC, DC

Polarity.....Normal, Inverted

Sensitivity Ranges

with 10:1 probe	20 mV to 1000 V/div
direct (1:1)	2 mV to 100 V/div

Dynamic Range..... > ±8 div (< 10 MHz)

..... > ±4 div (> 10 MHz)

Waveform Positioning Range..... ±4 divisions

Input Impedance on BNC, DC Coupled

4-channel models	1 MΩ (±1 %) // 14 pF (±2.25 pF)
2-channel models	1 MΩ (±1 %) // 15 pF (±2.25 pF)

Max. Input Voltage

For detailed specifications, see “Safety” on page 126

Vertical Accuracy ±(2.1 % + 0.04 range/div)

2 mV/div: ±(2.9 % + 0.08 range/div)

For voltage measurements with 10:1 probe, add probe accuracy, see section ‘10:1 Probe’ on page 129

Digitizer Resolution 8 bits, separate digitizer for each input

Horizontal

Minimum Time Base Speed (Scope Record) 2 min/div

Real Time Sampling Rate

FLUKE 190-50x	5 ns to 4 μs /div (3 or 4 channels) up to 1.25 GS/s
	2 ns to 4 μs /div (2 channels)..... up to 2.5 GS/s
	1 ns to 4 μs /div (1 channel) up to 5 GS/s
	10 μs to 120 s/div 125 MS/s

FLUKE190-202, -204:

	2 ns to 4 μs /div (1 or 2 channels) up to 2.5 GS/s
	5 ns to 4 μs /div (3 or 4 channels) up to 1.25 GS/s
	10 μs to 120 s/div 125 MS/s

FLUKE 190-102, -104:
 5 ns to 4 μ s /div (all channels)..... up to 1.25 GS/s
 10 μ s to 120 s/div 125 MS/s
 FLUKE 190-062:
 10 ns to 4 μ s /div (all channels)..... up to 625 MS/s
 10 μ s to 120 s/div 125 MS/s

Glitch Detection
 4 μ s to 120 s/divdisplays glitches as fast as 8 ns
 Waveform DisplayA, B, C, D,
 Math (+, -, x, X-Y mode, spectrum)
 Normal, Average, Persistence, Reference
 Time Base Accuracy \pm (100 ppm + 0.04 div)

Record Length (all models): see table below.

Table 2. Record Length (all models, Samples/points per input)

Mode	Glitch Detect On	Glitch Detect Off	Max. Samplerate
Scope - Normal	300 min/max pairs	3k true samples compressed into 1 screen (300 samples per screen)	190-062: 625 MS/s 190-102/104: 1.25 GS/s 190-202/204: 2.5 GS/s (1 or 2 channels on)
Scope - Fast	300 min/max pairs	-	
Scope - Full	300 min/max pairs	10k true samples, compressed into 1 screen. Use Zoom and Scroll to see waveform details	190-204: 1.25 GS/s (3 or 4 channels on) 190-50x: 5 GS/s (1 channel on) 190-50x: 2.5 GS/s (2 channels on) 190-504: 1.25 GS/s (3 or 4 channels on)
Scope Record Roll		30k samples	4x 125 MS/s
Trend Plot		> 18k min/max/ average values per measurement	Up to 5 measurements per second

Trigger and Delay

Trigger Modes.....	Automatic, Edge, Video, Pulse Width, N-Cycle, External (190-xx2)
Trigger Delay	up to +1200 divisions
Pre Trigger View	one full screen length
Delay	-12 div to +1200 div
Max. Delay.....	48 s at 4 s/div

Automatic Connect-and-View Trigger

Source	A, B, C, D EXT (190-xx2)
Slope	Positive, Negative, Dual

Edge Trigger

Screen Update	Free Run, On Trigger, Single Shot
Source.....	A, B, C, D, EXT (190-xx2)
Slope.....	Positive, Negative, Dual
Trigger Level Control Range	±4 divisions
Trigger Sensitivity	
DC to 5 MHz at >5 mV/div.....	0.5 divisions
DC to 5 MHz at 2 mV/div and 5 mV/div	1 division
500 MHz (FLUKE 190-50x)	1 division
600 MHz (FLUKE 190-50x)	2 divisions
200 MHz (FLUKE 190-2xx)	1 division
250 MHz (FLUKE 190-2xx)	2 divisions
100 MHz (FLUKE 190-1xx)	1 division
150 MHz (FLUKE 190-1xx)	2 divisions
60 MHz (FLUKE 190-062).....	1 division
100 MHz (FLUKE 190-062).....	2 divisions

Isolated External Trigger (190-xx2)

Bandwidth	10 kHz
Modes	Automatic, Edge
Trigger Levels (DC to 10 kHz).....	120 mV, 1.2 V

Video Trigger

StandardsPAL, PAL+, NTSC, SECAM, Non-interlaced
 Modes Lines, Line Select, Field 1 or Field 2
 Source A
 Polarity Positive, Negative
 Sensitivity 0.7 division sync level

Pulse Width Trigger

Screen Update On Trigger, Single Shot
 Trigger Conditions <T, >T, =T ($\pm 10\%$), $\neq T$ ($\pm 10\%$)
 Source A
 Polarity Positive or negative pulse
 Pulse Time Adjustment Range 0.01 div. to 655 div.
 with a minimum of 300 ns (<T, >T) or 500 ns (=T, $\neq T$),
 a maximum of 10 s,
 and a resolution of 0.01 div. with a minimum of 50 ns

Continuous Auto Set

Autoranging attenuators and time base, automatic
 Connect-and-View™ triggering with automatic source
 selection.

Modes

Normal 15 Hz to max. bandwidth
 Low Frequency 1 Hz to max. bandwidth

Minimum Amplitude A, B, C, D

DC to 1 MHz 10 mV
 1 MHz to max. bandwidth 20 mV

Automatic Capturing Scope Screens

Capacity 100 Scope Screens

For viewing screens, see Replay function.

Automatic Scope Measurements

The accuracy of all readings is within \pm (% of reading + number of counts) from 18 °C to 28 °C. Add 0.1x (specific accuracy) for each °C below 18 °C or above 28 °C. For voltage measurements with 10:1 probe, add probe accuracy, see section '10:1 Probe' on page 129. At least 1.5 waveform period must be visible on the screen.

General

Inputs.....A, B, C and D
 DC Common Mode Rejection (CMRR) >100 dB
 AC Common Mode Rejection at 50, 60, or 400 Hz >60 dB

DC Voltage (VDC)

Maximum Voltage
 with 10:1 probe 1000 V
 direct (1:1)..... 300 V

Maximum Resolution
 with 10:1 probe 1 mV
 direct (1:1)..... 100 μ V

Full Scale Reading.....999 counts

Accuracy at 4 s to 10 μ s/div, FLUKE 190-xx2
 2 mV/div $\pm(1.5 \% + 10 \text{ counts})$
 5 mV/div to 100 V/div $\pm(1.5 \% + 6 \text{ counts})$

Accuracy at 4 s to 10 μ s/div, FLUKE 190-xx4
 2 mV/div $\pm(3 \% + 10 \text{ counts})$
 5 mV/div to 100 V/div $\pm(3 \% + 6 \text{ counts})$

Normal Mode AC Rejection at 50 or 60 Hz>60 dB

AC Voltage (VAC)

Maximum Voltage
 with 10:1 probe..... 1000 V
 direct (1:1) 300 V

Maximum Resolution
 with 10:1 probe..... 1 mV
 direct (1:1) 100 μ V

Full Scale Reading.....999 counts

Accuracy, FLUKE 190-xx2
 DC coupled:
 DC to 60 Hz..... $\pm(1.5 \% + 10 \text{ counts})$

AC coupled, low frequencies:
 50 Hz direct (1:1)..... $\pm(1.5 \% + 10 \text{ counts}) - 0.6\%$
 60 Hz direct (1:1)..... $\pm(1.5 \% + 10 \text{ counts}) - 0.4\%$
 With the 10:1 probe the low frequency roll off point will be lowered to 2 Hz, which improves the AC accuracy for low frequencies. When possible use DC coupling for maximum accuracy.

AC or DC coupled, high frequencies:

- 60 Hz to 20 kHz..... $\pm(2.5 \% + 15 \text{ counts})$
- 20 kHz to 1 MHz..... $\pm(5 \% + 20 \text{ counts})$
- 1 MHz to 25 MHz $\pm(10 \% + 20 \text{ counts})$

For higher frequencies the instrument's frequency roll off starts affecting accuracy.

Accuracy, FLUKE 190-xx4

DC coupled:

- DC to 60 Hz..... $\pm(3 \% + 10 \text{ counts})$

AC coupled, low frequencies:

- 50 Hz direct (1:1)..... $\pm(3 \% + 10 \text{ counts}) - 0.6\%$
- 60 Hz direct (1:1)..... $\pm(3 \% + 10 \text{ counts}) - 0.4\%$

With the 10:1 probe the low frequency roll off point will be lowered to 2 Hz, which improves the AC accuracy for low frequencies. When possible use DC coupling for maximum accuracy.

AC or DC coupled, high frequencies:

- 60 Hz to 20 kHz..... $\pm(4 \% + 15 \text{ counts})$
- 20 kHz to 1 MHz..... $\pm(6 \% + 20 \text{ counts})$
- 1 MHz to 25 MHz $\pm(10 \% + 20 \text{ counts})$

For higher frequencies the instrument's frequency roll off starts affecting accuracy.

Normal Mode DC Rejection >50 dB

All accuracies are valid if:

- The waveform amplitude is larger than one division
- At least 1.5 waveform period is on the screen

AC+DC Voltage (True RMS)

Maximum Voltage

- with 10:1 probe 1000 V
- direct (1:1) 300 V

Maximum Resolution

- with 10:1 probe 1 mV
- direct (1:1) 100 μ V

Full Scale Reading 1100 counts

Accuracy, FLUKE 190-xx2

- DC to 60 Hz..... $\pm(1.5 \% + 10 \text{ counts})$
- 60 Hz to 20 kHz..... $\pm(2.5 \% + 15 \text{ counts})$
- 20 kHz to 1 MHz..... $\pm(5 \% + 20 \text{ counts})$
- 1 MHz to 25 MHz..... $\pm(10 \% + 20 \text{ counts})$

For higher frequencies the instrument's frequency roll off starts affecting accuracy.

Accuracy, FLUKE 190-xx4

- DC to 60 Hz..... $\pm(3 \% + 10 \text{ counts})$
- 60 Hz to 20 kHz..... $\pm(4 \% + 15 \text{ counts})$
- 20 kHz to 1 MHz..... $\pm(6 \% + 20 \text{ counts})$
- 1 MHz to 25 MHz..... $\pm(10 \% + 20 \text{ counts})$

For higher frequencies the instrument's frequency roll off starts affecting accuracy.

Amperes (AMP)

With Optional Current Probe or Current Shunt

Rangessame as VDC, VAC, VAC+DC

Probe Sensitivity 100 μ V/A, 1 mV/A, 10 mV/A,
100 mV/A, 400 mV/A, 1 V/A, 10 V/A, and 100 V/A

Accuracysame as VDC, VAC, VAC+DC
(add current probe or current shunt accuracy)

Peak

ModesMax peak, Min peak, or peak-to-peak

Maximum Voltage
with 10:1 probe 1000 V
direct (1:1)..... 300 V

Maximum Resolution
with 10:1 probe 10 mV
direct (1:1)..... 1 mV

Full Scale Reading..... 800 counts

Accuracy
Max peak or Min peak..... \pm 0.2 division
Peak-to-peak..... \pm 0.4 division

Frequency (Hz)

Range1.000 Hz to full bandwidth

Full Scale Reading..... 999 counts

Accuracy

1 Hz to full bandwidth \pm (0.5 % +2 counts)
(4 s/div to 10 ns/div and 10 periods on the screen).

Duty Cycle (DUTY)

Range 4.0 % to 98.0 %

Resolution0.1 % (when period > 2 div)

Full Scale Reading999 counts (3-digit display)

Accuracy (logic or pulse) \pm (0.5 % +2 counts)

Pulse Width (PULSE)

Resolution (with GLITCH off) 1/100 division

Full Scale Reading999 counts

Accuracy

1 Hz to full bandwidth \pm (0.5 % +2 counts)

Vpwm

Purpose..... to measure on pulse width modulated
signals, like motor drive inverter outputs

Principle readings show the effective voltage based
on the average value of samples over a
whole number of periods of the fundamental
frequency

Accuracy as Vrms for sinewave signals

V/Hz

Purpose to show the measured Vpwm value
(see Vpwm) divided by the fundamental frequency
on Variable AC Motor Speed drives.

Accuracy %Vrms + %Hz

Note

AC motors are designed for use with a rotating magnetic field of constant strength. This strength depends on the applied voltage (Vpwm) divided by the fundamental frequency of the applied voltage (Hz). The nominal Volt and Hz value are shown on the motor type plate.

Power (A and B, C and D)

Power Factor..... ratio between Watts and VA
Range 0.00 to 1.00

Watt RMS reading of multiplication
corresponding samples of input A or C (volts)
and Input B or D (amperes)

Full Scale Reading 999 counts

VA Vrms x Arms
Full Scale Reading 999 counts

VA Reactive (VAR) $\sqrt{((VA)^2 - W^2)}$
Full Scale Reading 999 counts

Phase (A and B, C and D)

Range..... -180 to +180 degrees

Resolution 1 degree

Accuracy
0.1 Hz to 1 MHz..... ±2 degrees
1 MHz to 10 MHz..... ±3 degrees

Temperature (TEMP)

With Optional Temperature Probe (°F not for Japan)

Ranges (°C or °F)..... -40.0 to +100.0 °
-100 to +250 °
-100 to +500 °
-100 to +1000 °
-100 to + 2500 °

Probe Sensitivity..... 1 mV/°C and 1 mV/°F

Accuracy ±(1.5 % + 5 counts)
(add temperature probe accuracy for overall accuracy)

Decibel (dB)

dBV dB relative to one volt

dBm..... dB relative to one mW in 50 Ω or 600 Ω

dB on..... VDC, VAC, or VAC+DC

Accuracy same as VDC, VAC, VAC+DC

Meter Measurements for Fluke 190-xx4

Four of the Automatic Scope Measurements as defined above may be displayed at the same time, using larger screen area for convenient reading, suppressing the scope waveform information. For specifications see Automatic scope Measurements above.

Meter Measurements for Fluke 190-xx2

The accuracy of all measurements is within \pm (% of reading + number of counts) from 18 °C to 28 °C. Add 0.1x (specific accuracy) for each °C below 18 °C or above 28 °C.

Meter Input (Banana Jacks)

Input CouplingDC
Frequency ResponseDC to 10 kHz (-3 dB)
Input Impedance 1 M Ω (\pm 1 %)//14 pF (\pm 1.5 pF)

 Max. Input Voltage 1000 V CAT III
600 V CAT IV

(For detailed specifications, see “Safety”)

Meter Functions

Ranging.....Auto, Manual
Modes Normal, Relative

General

DC Common Mode Rejection (CMRR)>100 dB
AC Common Mode Rejection at 50, 60, or 400 Hz>60 dB

Ohms (Ω)

Ranges	500.0 Ω , 5.000 k Ω , 50.00 k Ω , 500.0 k Ω , 5.000 M Ω , 30.00 M Ω
Full Scale Reading	
500 Ω to 5 M Ω	5000 counts
30 M Ω	3000 counts
Accuracy	$\pm(0.6\% +6 \text{ counts})$
Measurement Current	0.5 mA to 50 nA, $\pm 20\%$ decreases with increasing ranges
Open Circuit Voltage	<4 V

Continuity (CONT)

Beep	<50 Ω ($\pm 30 \Omega$)
Measurement Current	0.5 mA, $\pm 20\%$
Detection of shorts of	≥ 1 ms

Diode

Maximum Voltage Reading	2.8 V
Open Circuit Voltage	<4 V
Accuracy	$\pm(2\% +5 \text{ counts})$
Measurement Current	0.5 mA, $\pm 20\%$

Temperature (TEMP)

With Optional Temperature Probe

Ranges ($^{\circ}\text{C}$ or $^{\circ}\text{F}$).....	-40.0 to +100.0 $^{\circ}$ -100.0 to +250.0 $^{\circ}$ -100.0 to +500.0 $^{\circ}$ -100 to +1000 $^{\circ}$ -100 to + 2500 $^{\circ}$
----------------------------------------------------------	---------------------------------------------------------------------------------------------------------------------------------------------------

Probe Sensitivity..... 1 mV/ $^{\circ}\text{C}$ and 1 mV/ $^{\circ}\text{F}$

DC Voltage (VDC)

Ranges.....	500.0 mV, 5.000 V, 50.00 V, 500.0 V, 1100 V
Full Scale Reading	5000 counts
Accuracy	$\pm(0.5\% +6 \text{ counts})$
Normal Mode AC Rejection at 50 or 60 Hz $\pm 1\%$	>60 dB

AC Voltage (VAC)

Ranges.....	500.0 mV, 5.000 V, 50.00 V, 500.0 V, 1100 V
Full Scale Reading	5000 counts
Accuracy	
15 Hz to 60 Hz.....	$\pm(1\% +10 \text{ counts})$
60 Hz to 1 kHz.....	$\pm(2.5\% +15 \text{ counts})$
For higher frequencies the frequency roll off of the Meter input starts affecting accuracy.	
Normal Mode DC Rejection.....	>50 dB

AC+DC Voltage (True RMS)

Ranges 500.0 mV, 5.000 V, 50.00 V, 500.0 V, 1100 V

Full Scale Reading..... 5000 counts

Accuracy

DC to 60 Hz $\pm(1\% + 10 \text{ counts})$

60 Hz to 1 kHz $\pm(2.5\% + 15 \text{ counts})$

For higher frequencies the frequency roll off of the Meter input starts affecting accuracy.

All accuracies are valid if the waveform amplitude is larger than 5 % of full scale.

Amperes (AMP)

With Optional Current Probe or Current Shunt

Ranges same as VDC, VAC, VAC+DC

Probe Sensitivity 100 $\mu\text{V/A}$, 1 mV/A , 10 mV/A ,
100 mV/A , 1 V/A , 10 V/A , and 100 V/A

Accuracy same as VDC, VAC, VAC+DC
(add current probe or current shunt accuracy)

Recorder

TrendPlot (Meter or Scope)

Chart recorder that plots a graph of min and max values of Meter or Scope measurements over time.

Measurement Speed..... >5 measurements/s

Time/Div..... 5 s/div to 30 min/div

Record Size (min, max, average)..... 19200 points

Recorded Time Span 64 min to 546 hours

.....

Time Reference time from start, time of day

Scope Record

Records scope waveforms in deep memory while displaying the waveform in Roll mode.

Source..... Input A, B, C, D

Max. Sample Speed (4 ms/div to 1 min/div) 125 MS/s

Glitch capture (4 ms/div to 2 min/div) 8 ns

Time/Div in normal mode 4 ms/div to 2 min/div

Record Size 30k points per waveform

Recorded Time Span 4.8 s to 40 hours

Miscellaneous

Display

View Area	126.8 x 88.4 mm (4.99 x 3.48 inches)
Resolution.....	320 x 240 pixels
Backlight	LED (Temperature compensated)
Brightness.....	Power Adapter: 200 cd/m ² Battery Power: 90 cd/ m ²
Display Auto-OFF time (battery saving)	30 seconds, 5 minutes or disabled

Power

FLUKE 190-xx4, -50x: Rechargeable Li-ion Battery (model BP291):	
Operating Time	up to 7 hours (Low Intensity)
Charging Time	5 hours
Capacity/Voltage.....	52 Wh / 10.8 V
FLUKE 190-062, -102, -202: Rechargeable Li-ion Battery (model BP290):	
Operating Time	up to 4 hours (Low Intensity)
Charging Time	2.5 hours
Capacity/Voltage.....	26 Wh / 10.8 V

Rechargeable Li-ion Battery (model BP 290 and BP291):	
Life Time (> 80 % capacity).....	300x charge/discharge
Allowable ambient temperature during charging:	0 to 40 °C (32 to 104 °F)
Auto power down time (battery saving):.....	5 min, 30 min or disabled

Power Adapter BC190:

- BC190/801 European line plug 230 V ±10 %
- BC190/813 North American line plug 120 V ±10 %
- BC190/804 United Kingdom line plug 230 V ±10 %
- BC190/806 Japanese line plug 100 V ±10 %
- BC190/807 Australian line plug 230 V ±10 %
- BC190/808 Universal switchable adapter 115 V ±10 % or 230 V ±10 %, with plug EN60320-2.2G
- BC190/820 Universal adapter 100...240 V ±10 %, with plug EN60320-2.2G

Line Frequency	50 and 60 Hz
----------------------	--------------

Probe Calibration

Manual pulse adjustment and automatic DC adjustment with probe check

Generator Output	1.225 Vpp / 500 Hz square wave
------------------------	-----------------------------------

Internal Memory

Number of Scope Memories	30
Each memory can contain 2/4 waveforms plus corresponding setups	
Number of Recorder Memories.....	10
Each memory can contain:	
• a 2/4 channel input TrendPlot	
• a 2/4 channel input Scope Record	
• 100 2/4 channel input Scope screens (Replay)	
Number of Screen Image memories	9
Each memory can contain one screen image	

External Memory

USB stick, 2GB max

Mechanical

Size.....	265 x 190 x 70 mm (10.5 x 7.5 x 2.8 in)
Weight	
FLUKE 190-xx4.....	2.2 kg (4.8 lbs) including battery
FLUKE 190-5xx.....	2.2 kg (4.8 lbs) including battery
FLUKE 190-xx2.....	2.1 kg (4.6 lbs) including battery

Interface Ports

Two USB ports provided. Ports are fully insulated from instrument's floating measurement circuitry.

- A USB-host port directly connects to external flash memory drive ('USB-stick', ≤ 2 GB) for storage of waveform data, measurement results, instrument settings and screen copies.
- A mini-USB-B is provided which allows for interconnection to PC for remote control and data transfer using SW90W (FlukeView® software for Windows®).
- One port can be active at the same time, therefore remote control and data transfer via mini-USB is not possible when saving or recalling data to or from the USB-stick.

Environmental

Environmental.....MIL-PRF-28800F, Class 2

Temperature

Operating:

battery installed..... 0 to 40 °C (32 to 104 °F)

no battery installed..... 0 to 50 °C (32 to 122 °F)

Storage-20 to +60 °C (-4 to +140 °F)

Humidity (Maximum Relative)

Operating:

0 to 10 °C (32 to 50 °F) noncondensing

10 to 30 °C (50 to 86 °F) 95 % (± 5 %)

30 to 40 °C (86 to 104 °F) 75 % (± 5 %)

40 to 50 °C (104 to 122 °F) 45 % (± 5 %)

Storage:

-20 to +60 °C (-4 to +140 °F)..... noncondensing

Altitude

Operating:

CATIII 600V, CATII 1000V 3 km (10 000 feet)

CATIV 600V, CATIII 1000V..... 2 km (6 600 feet)

Storage 12 km (40 000 feet)

Vibration (Sinusoidal)..... max. 3 g



Vibration (Random)..... 0.03 g²/Hz

Shock..... max. 30 g

Electromagnetic EnvironmentEN/IEC61326-1
(Portable Equipment)

Enclosure Protection IP51, ref: IEC60529

Standards

Conforms to   

Electromagnetic Compatibility.....Applies to use in Korea only,
Class A Equipment (Industrial
Broadcasting &
Communication Equipment) ^[1]

[1] This product meets requirements
for industrial (Class A)
electromagnetic wave equipment
and the seller or user should take
notice of it. This equipment is
intended for use in business
environments and is not to be used
in homes.

MAX. INPUT
VOLTAGE (Vrms)

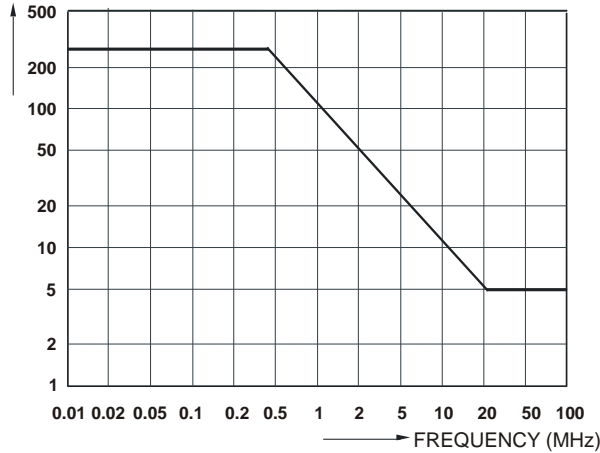

Figure 51. Max. Input Voltage vs. Frequency

VOLTAGE (Vrms)

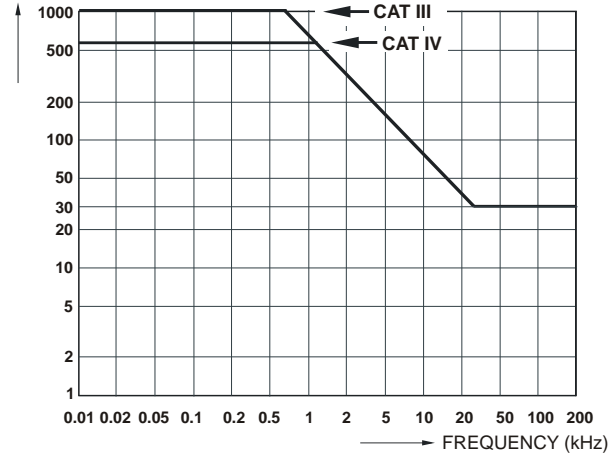

Figure 52. Safe Handling: Max. Voltage Between Scope References, and Between Scope References and earth ground.

10:1 Probe VPS410

Accuracy

Probe accuracy when adjusted on the test tool:

DC to 20 kHz..... ± 1 %

20 kHz to 1 MHz..... ± 2 %

1 MHz to 25 MHz ± 3 %

For higher frequencies the probe's roll off starts affecting the accuracy.

For further probe specifications see the instruction sheet supplied with the VPS410 probe set.

Electromagnetic Immunity

The Fluke 190 Series II test tools, including standard accessories are compliant to EN61326-1, with the addition of the following table

Scope Mode (10 ms/div: Waveform disturbance with VPS410 voltage probe shorted. (Table 3)

Table 3. (E = 3V/m)

Frequency	No Disturbance	Disturbance < 10% of full scale	Disturbance > 10% of full scale
80 MHz – 450 MHz	≥ 500 mV/d	100, 200 mV/div	2, 5, 10, 20, 50 mV/div
450 MHz – 1 GHz	All ranges		
1.4 GHz – 2 GHz	All ranges		
2 GHz – 2.7 GHz (1 V/m)	All Ranges		

Appendices

Appendix	Title	Page
A	Installing USB Drivers.....	A-1
B	Battery Pack MSDS	B-1
C	Instrument Security Procedures	C-1

ScopeMeter® Test Tool 190 Series II

Users Manual

Appendix A

Installing USB Drivers

Introduction

The Fluke 190 Series II ScopeMeter® comes with a USB interface (connector: USB type “B mini”) for communication with a computer. To be able to communicate with the instrument, drivers need to be loaded onto the computer. This document describes how to install the drivers on a Windows XP computer. Installing on other Windows versions will be similar.

Drivers for Windows XP, Vista and Win 7 are available from the Windows Driver Distribution Center, and can be downloaded automatically if your computer is connected to the internet.

The drivers have passed Windows Logo Verification and are signed by Microsoft Windows Hardware Compatibility Publisher. This is required for installation on Win 7.

Note

The Fluke 190 Series II instrument requires two drivers to be loaded in sequence.

- *1st it requires installation of the Fluke 190 ScopeMeter® USB driver*
- *2nd it requires installation of the Fluke USB Serial port*

Both of these drivers need to be installed to be able to communicate with the ScopeMeter®!

Installing the USB Drivers

To install the USB drivers, do the following:

- 1 Connect the Fluke 190 Series II instrument to the PC. The USB cable can be plugged in and out (hot-swap) when both the computer and the instrument are on. It is not required to power off.

When there is no driver loaded for the Fluke 190 Series II instrument, Windows will show that there is New Hardware detected, and the Wizard for installing new hardware will open.

Depending on your PC settings, Windows may ask for permission to search the Windows Update Web site on the internet for the latest revision. When you have an internet connection it is advised to select “Yes” and click Next. To install drivers from the CD-ROM or from a location on the hard drive select “No, not this time”.



- 2 In the following window click 'Next' to install the software automatically.

Windows will download the drivers automatically from the Windows Driver Distribution Center on the internet. If there is no connection to the internet, you need to load the CD-ROM, supplied with the ScopeMeter[®], which contains the drivers.

- 3 Follow the instructions on screen.

When the driver has finished installation click 'Finish' to complete the first step of the driver installation.



- 4 After completing the first step the New Hardware Wizard will start again to install the USB Serial Port Driver.

Click 'Next' to install the software automatically.

Windows will download the drivers automatically from the Windows Driver Distribution Center on the internet. If there is no connection to the internet, you need to load the CD-ROM, supplied with the ScopeMeter®, which contains the drivers.

- 5 Follow the instructions on screen.

When the driver finished installation click 'Finish' to complete the final step of the driver installation.

You are now ready to use the ScopeMeter® with FlukeView® Software SW90W from version V5.1 onwards.



6 To check if the drivers are loaded properly, connect the ScopeMeter® 190 Series II to your computer and open the Device Manager. (See the Help file of your computer how to open the device manager for your Windows version)

From the device manager click on the + sign to Expand the 'Universal Serial Bus controllers'. The 'Fluke 190 ScopeMeter®' should be listed here.

From the device manager click on the + sign to Expand the 'Ports (COM & LPT)' Universal Serial Bus controllers. The 'Fluke USB Serial Port COM(5)' should be listed here.

Note that the COM port number may differ and is automatically assigned by Windows.

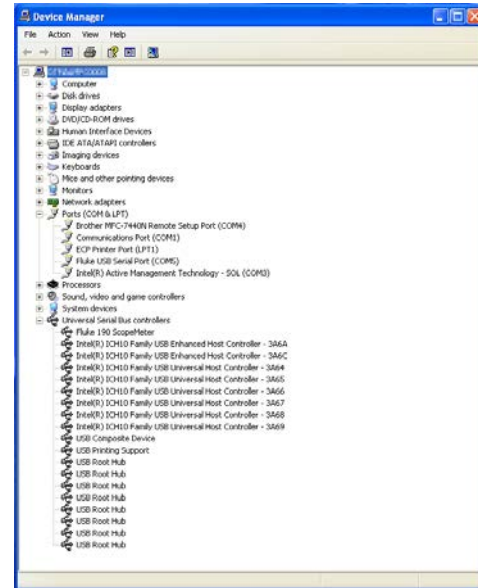

Notes

- 1) *Sometimes application software may require a different port number. (for example in the range Com 1..4). In this situation the COM port number can be changed manually.
To manually assign a different COM port number right click on 'Fluke USB Serial Port COM(5)' and select properties. From the Properties menu, select the Port Settings tab, and click 'Advanced...' to change the port number.*
- 2) *Sometimes other applications installed on the PC automatically occupy the newly created port. On most situations it is sufficient to unplug the Fluke 190 Series II ScopeMeter® USB cable shortly and then re-connect the cable.*

Appendix B **Battery Pack MSDS**

Li-ion Battery Pack

Contact Fluke for a Battery Material Safety Data Sheet (MSDS) or Compliance Information.

Appendix C

Instrument Security Procedures

Memory

The 190 Series II ScopeMeter® test tool has the following memory devices:

1. D4000 Controller “Spider”. Contains a mask ROM 4kx32 with a initial program with the operating code for the product and a RAM 1kx32 to temporarily store stack values for computing actions.
2. D4001: 1 x 4 Mb SRAM memory used to store:
 - the actual screen and instrument setup.
 - saved screens and instrument setups.
3. D5000, D5002:
2 x 64 Mb Flash EEPROM.
Non-volatile memory used to store operating code (instrument firmware) for the product, and to store calibration constants.
4. D5001, D5003: 2 x 8 Mb SRAM memory used to store:
 - the actual screen and instrument setup
 - saved screens and instrument setups

Security Summary

The operating code (instrument firmware) stored in D5000, D5002 can be read using dedicated remote interface commands (only available for use by Product Development).

The instrument firmware can be loaded using a dedicated Fluke software program (only available for Fluke (authorized) workshops).

Calibration constants stored in D5000, D5002 can be read using special remote interface commands (only available for use by Product Development). The calibration constants are generated when the meter is sent through its calibration process and are fundamental to the test tool operation.

To clear the saved screens and instrument setups:

- 1  Push the SAVE button.

- 2  Press F4 – FILE OPTIONS...

If you see a screen like figure C-1, no screens and instrument setups are stored. Press the F4 key (CLOSE) to exit.

If you see a screen like figure C-2, continue at step 3 below.

C-2

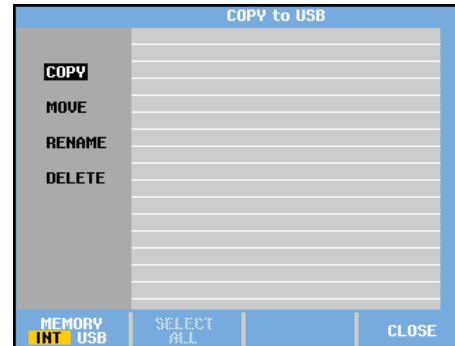

Figure C-1. Screen if memory is empty

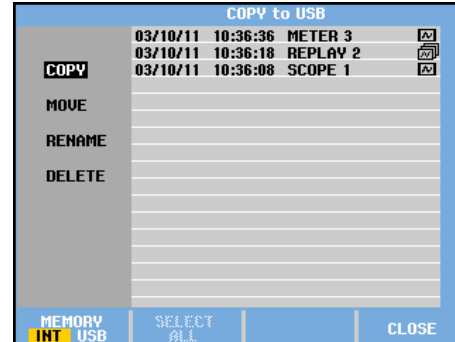







Figure C-2. Screen if memory is not empty

- 3  Select DELETE with the up/down arrow keys.
- 4  Press ENTER.
- 5  Press F2 – SELECT ALL.
- 6  Press ENTER.
- 7  Press F4 – YES to confirm the Clear action.

If the test tool is not powered through its Power Adapter removing the battery for 10 minutes will clear all data stored in SRAM. For this proceed as follows: disconnect the Test Tool from all voltage sources, open the battery door present at the rear panel and lift the battery out of the instrument.

Компания «Life Electronics» занимается поставками электронных компонентов импортного и отечественного производства от производителей и со складов крупных дистрибьюторов Европы, Америки и Азии.

С конца 2013 года компания активно расширяет линейку поставок компонентов по направлению коаксиальный кабель, кварцевые генераторы и конденсаторы (керамические, пленочные, электролитические), за счёт заключения дистрибьюторских договоров

Мы предлагаем:

- Конкурентоспособные цены и скидки постоянным клиентам.
- Специальные условия для постоянных клиентов.
- Подбор аналогов.
- Поставку компонентов в любых объемах, удовлетворяющих вашим потребностям.
- Приемлемые сроки поставки, возможна ускоренная поставка.
- Доставку товара в любую точку России и стран СНГ.
- Комплексную поставку.
- Работу по проектам и поставку образцов.
- Формирование склада под заказчика.
- Сертификаты соответствия на поставляемую продукцию (по желанию клиента).
- Тестирование поставляемой продукции.
- Поставку компонентов, требующих военную и космическую приемку.
- Входной контроль качества.
- Наличие сертификата ISO.

В составе нашей компании организован Конструкторский отдел, призванный помогать разработчикам, и инженерам.

Конструкторский отдел помогает осуществить:

- Регистрацию проекта у производителя компонентов.
- Техническую поддержку проекта.
- Защиту от снятия компонента с производства.
- Оценку стоимости проекта по компонентам.
- Изготовление тестовой платы монтаж и пусконаладочные работы.



Тел: +7 (812) 336 43 04 (многоканальный)
Email: org@lifeelectronics.ru