



1N4154

High Conductance Fast Diode

Features

- 500 milliwatt Power Dissipation package.
- Fast Switching Speed.
- Typical capacitance less than 1.0 picofarad.

General Description

The high breakdown voltage, fast switching speed and high forward conductance of this diode packaged in a DO-35 miniature Glass Axial leaded package makes it desirable also as a general purpose diode.



DO-35
Color Band Denotes Cathode

Absolute Maximum Ratings * $T_A = 25^\circ\text{C}$ unless otherwise noted

Symbol	Parameter	Value	Unit
W_{IV}	Working Inverse Voltage	35	V
I_O	Average Rectified Current	100	mA
I_F	DC Forward Current (I_F)	300	mA
i_f	Recurrent Peak Forward Current (I_F)	400	mA
$i_{F(\text{surge})}$	Peak Forward Surge Current (I_{FSM}) Pulse Width = 1.0 second Pulse Width = 1.0 microsecond	1.0	A
		4.0	A
T_{STG}	Storage Temperature Range	-65 to +200	$^\circ\text{C}$
T_J	Operating Junction Temperature	175	$^\circ\text{C}$

* These ratings are limiting values above which the serviceability of any semiconductor device may be impaired.

Thermal Characteristics

Symbol	Parameter	Value	Unit
P_D	Total Power Dissipation at $T_A = 25^\circ\text{C}$	500	mW
	Linear Derating Factor from $T_A = 25^\circ\text{C}$	3.33	mW/ $^\circ\text{C}$
$R_{\theta JA}$	Thermal Resistance, Junction to Ambient	300	$^\circ\text{C}/\text{W}$

Electrical Characteristics $T_A = 25^\circ\text{C}$ unless otherwise noted

Symbol	Parameter	Conditions	Min.	Max	Units
B_V	Breakdown Voltage	$I_R = 5.0\mu\text{A}$	35		V
I_R	Reverse Leakage	$V_R = 25\text{V}$ $V_R = 25\text{V}, T_A = 150^\circ\text{C}$		100 100	nA μA
V_F	Forward Voltage	$I_F = 30\text{mA}$		1.0	V
C_T	Capacitance	$V_R = 0, f = 1.0\text{MHz}$		4.0	pF
T_{RR}	Reverse Recovery Time	$I_F = 10\text{mA}, V_R = 6.0\text{V}$ $I_{RR} = 1.0\text{mA}, R_L = 100\Omega$		4.0	ns

Physical Dimensions (DO-35)

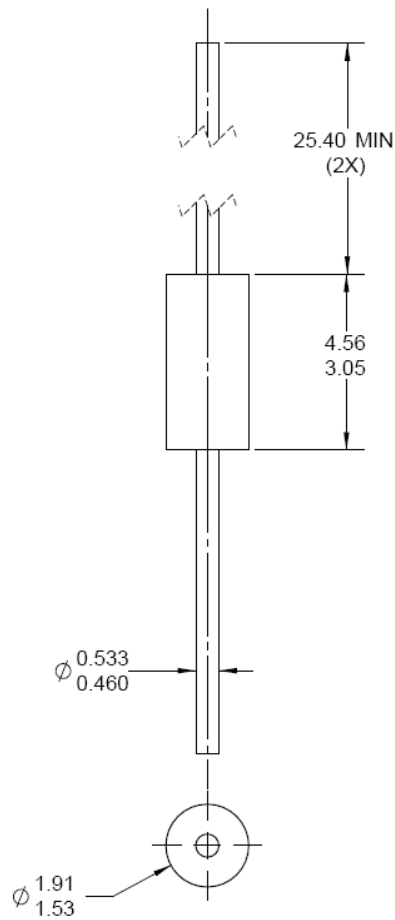







NOTES: UNLESS OTHERWISE SPECIFIED

- A) PACKAGE STANDARD REFERENCE: JEDEC DO-204, VARIATION AH.
- B) HERMETICALLY SEALED GLASS PACKAGE.
- C) PACKAGE WEIGHT IS 0.137 GRAM.
- D) ALL DIMENSIONS ARE IN MILLIMETERS.
- E) DRAWING FILE NAME: DO35AREV02



TRADEMARKS

The following includes registered and unregistered trademarks and service marks, owned by Fairchild Semiconductor and/or its global subsidiaries, and is not intended to be an exhaustive list of all such trademarks.

AccuPower™	FPS™	PowerTrench®	The Power Franchise®
Auto-SPM™	F-PFS™	PowerXS™	the power franchise™
Build it Now™	FRFET®	Programmable Active Droop™	TinyBoost™
CorePLUS™	Global Power Resource™	QFET®	TinyBuck™
CorePOWER™	Green FPS™	QS™	TinyCalc™
CROSSVOLT™	Green FPS™ e-Series™	Quiet Series™	TinyLogic®
CTL™	Gmax™	RapidConfigure™	TINYOPTO™
Current Transfer Logic™	GTO™	 ™	TinyPower™
EcoSPARK®	IntelliMAX™	Saving our world, 1mW/W/kW at a time™	TinyPWM™
EfficientMax™	ISOPLANAR™	SmartMax™	TinyWire™
EZSWITCH™*	MegaBuck™	SMART START™	TriFault Detect™
 ™*	MICROCOUPLER™	SPM®	TRUECURRENT™*
 ®	MicroFET™	STEALTH™	µSerDes™
Fairchild®	MicroPak™	SuperFET™	 ™
Fairchild Semiconductor®	MillerDrive™	SuperSOT™-3	UHC®
FACT Quiet Series™	MotionMax™	SuperSOT™-6	Ultra FRFET™
FACT®	Motion-SPM™	SuperSOT™-8	UniFET™
FAST®	OPTOLOGIC®	SupreMOS™	VCX™
FastvCore™	OPTOPLANAR®	SyncFET™	VisualMax™
FETBench™	 ™	Sync-Lock™	XS™
FlashWriter®*	PDP SPM™	 ™*	
	Power-SPM™		

* Trademarks of System General Corporation, used under license by Fairchild Semiconductor.

DISCLAIMER

FAIRCHILD SEMICONDUCTOR RESERVES THE RIGHT TO MAKE CHANGES WITHOUT FURTHER NOTICE TO ANY PRODUCTS HEREIN TO IMPROVE RELIABILITY, FUNCTION, OR DESIGN. FAIRCHILD DOES NOT ASSUME ANY LIABILITY ARISING OUT OF THE APPLICATION OR USE OF ANY PRODUCT OR CIRCUIT DESCRIBED HEREIN; NEITHER DOES IT CONVEY ANY LICENSE UNDER ITS PATENT RIGHTS, NOR THE RIGHTS OF OTHERS. THESE SPECIFICATIONS DO NOT EXPAND THE TERMS OF FAIRCHILD'S WORLDWIDE TERMS AND CONDITIONS, SPECIFICALLY THE WARRANTY THEREIN, WHICH COVERS THESE PRODUCTS.

LIFE SUPPORT POLICY

FAIRCHILD'S PRODUCTS ARE NOT AUTHORIZED FOR USE AS CRITICAL COMPONENTS IN LIFE SUPPORT DEVICES OR SYSTEMS WITHOUT THE EXPRESS WRITTEN APPROVAL OF FAIRCHILD SEMICONDUCTOR CORPORATION.

As used herein:

1. Life support devices or systems are devices or systems which, (a) are intended for surgical implant into the body or (b) support or sustain life, and (c) whose failure to perform when properly used in accordance with instructions for use provided in the labeling, can be reasonably expected to result in a significant injury of the user.
2. A critical component in any component of a life support, device, or system whose failure to perform can be reasonably expected to cause the failure of the life support device or system, or to affect its safety or effectiveness.

ANTI-COUNTERFEITING POLICY

Fairchild Semiconductor Corporation's Anti-Counterfeiting Policy. Fairchild's Anti-Counterfeiting Policy is also stated on our external website, www.fairchildsemi.com, under Sales Support.

Counterfeiting of semiconductor parts is a growing problem in the industry. All manufacturers of semiconductor products are experiencing counterfeiting of their parts. Customers who inadvertently purchase counterfeit parts experience many problems such as loss of brand reputation, substandard performance, failed applications, and increased cost of production and manufacturing delays. Fairchild is taking strong measures to protect ourselves and our customers from the proliferation of counterfeit parts. Fairchild strongly encourages customers to purchase Fairchild parts either directly from Fairchild or from Authorized Fairchild Distributors who are listed by country on our web page cited above. Products customers buy either from Fairchild directly or from Authorized Fairchild Distributors are genuine parts, have full traceability, meet Fairchild's quality standards for handling and storage and provide access to Fairchild's full range of up-to-date technical and product information. Fairchild and our Authorized Distributors will stand behind all warranties and will appropriately address any warranty issues that may arise. Fairchild will not provide any warranty coverage or other assistance for parts bought from Unauthorized Sources. Fairchild is committed to combat this global problem and encourage our customers to do their part in stopping this practice by buying direct or from authorized distributors.

PRODUCT STATUS DEFINITIONS

Definition of Terms

Datasheet Identification	Product Status	Definition
Advance Information	Formative / In Design	Datasheet contains the design specifications for product development. Specifications may change in any manner without notice.
Preliminary	First Production	Datasheet contains preliminary data; supplementary data will be published at a later date. Fairchild Semiconductor reserves the right to make changes at any time without notice to improve design.
No Identification Needed	Full Production	Datasheet contains final specifications. Fairchild Semiconductor reserves the right to make changes at any time without notice to improve the design.
Obsolete	Not In Production	Datasheet contains specifications on a product that is discontinued by Fairchild Semiconductor. The datasheet is for reference information only.

Компания «Life Electronics» занимается поставками электронных компонентов импортного и отечественного производства от производителей и со складов крупных дистрибьюторов Европы, Америки и Азии.

С конца 2013 года компания активно расширяет линейку поставок компонентов по направлению коаксиальный кабель, кварцевые генераторы и конденсаторы (керамические, пленочные, электролитические), за счёт заключения дистрибьюторских договоров

Мы предлагаем:

- Конкурентоспособные цены и скидки постоянным клиентам.
- Специальные условия для постоянных клиентов.
- Подбор аналогов.
- Поставку компонентов в любых объемах, удовлетворяющих вашим потребностям.
- Приемлемые сроки поставки, возможна ускоренная поставка.
- Доставку товара в любую точку России и стран СНГ.
- Комплексную поставку.
- Работу по проектам и поставку образцов.
- Формирование склада под заказчика.
- Сертификаты соответствия на поставляемую продукцию (по желанию клиента).
- Тестирование поставляемой продукции.
- Поставку компонентов, требующих военную и космическую приемку.
- Входной контроль качества.
- Наличие сертификата ISO.

В составе нашей компании организован Конструкторский отдел, призванный помогать разработчикам, и инженерам.

Конструкторский отдел помогает осуществить:

- Регистрацию проекта у производителя компонентов.
- Техническую поддержку проекта.
- Защиту от снятия компонента с производства.
- Оценку стоимости проекта по компонентам.
- Изготовление тестовой платы монтаж и пусконаладочные работы.



Тел: +7 (812) 336 43 04 (многоканальный)
Email: org@lifeelectronics.ru