

# LED Driver Demoboard

## Input 230VAC // Output 350mA, 40V (14W)

### General Description

The HV9931 LED driver is primarily targeted at low to medium power LED lighting applications where galvanic isolation of the LED string is not an essential requirement. The driver provides near unity power factor and constant current regulation using a two stage topology driven by a single MOSFET and control IC. Triac dimming of this design is possible with the addition of some components for preloading and inrush current shaping.

The DB1 and DB2 Demoboards were designed for a fixed string current of 350mA and a string voltage of 40V for a load power of about 14W. The boards will regulate current for an output voltage down to 0V.

Nominal input voltage for the DB1 is 120VAC, for the DB2 230VAC. Design for universal input (85 to 265VAC) is by all means possible but does increase cost and size while lowering efficiency.

The input EMI filter was designed to suppress the differential mode switching noise to meet CISPR15 requirements. No specific components were added to suppress currents of common mode nature. Common mode current can be controlled in many ways to satisfy CISPR 15 requirements.

The board is fitted with a number of optional circuits; a schematic of a simplified driver is given as well. The circuits

featured are output current soft start and protections from line overvoltage, load overvoltage and open circuit. The driver is inherently short circuit proof by virtue of the peak current regulation method.

Specifications	
Input voltage:	200V <sub>RMS</sub> to 265V <sub>RMS</sub> , 50Hz
Output voltage:	0 to 40V
Output current:	350mA +/-5%
Output power:	14W
Power factor	98%
Total harmonic distortion	EN61000-3-2 Class C
EMI limits	CISPR 15 (see text)
Efficiency	83%
Output current ripple	30% <sub>PP</sub>
Input overvoltage protection	265V <sub>RMS</sub> , Non-Latching
Output overvoltage protection	46V, Latching
Switching frequency	80kHz <sub>NOM</sub>
Dimensions:	3.5" x 3.0" x 1.25"

### Board Layout and Connections

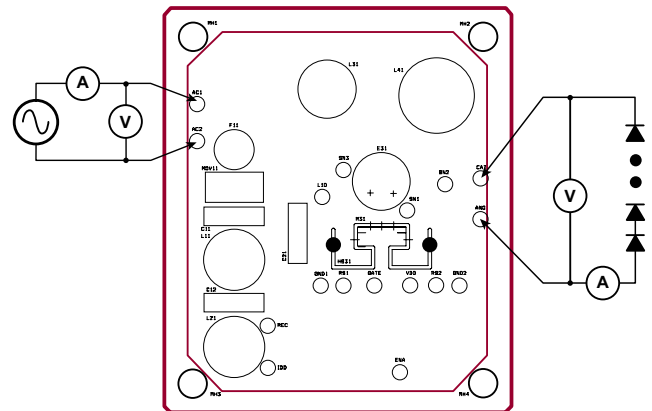

**Warning!**

*Working with this board can cause serious bodily harm or death. Connecting the board to a source of line voltage will result in the presence of hazardous voltage throughout the system including the LED load.*

*The board should only be handled by persons well aware of the dangers involved with working on live electrical equipment. Extreme care should be taken to protect against electric shock. Disconnect the board before attempting to make any changes to the system configuration. Always work with another person nearby who can offer assistance in case of an emergency. Wear safety glasses for eye protection.*

**Special Note:**

*The electrolytic capacitor carries a hazardous voltage for an extended time after the board is disconnected. The board includes a 1M $\Omega$  resistor placed across the electrolytic capacitor which will slowly discharge the capacitor after disconnection from line voltage. The voltage will fall more or less exponentially to zero with a time constant of about 100 seconds. Check the capacitor voltage before handling the board.*

**Connection Instructions****Step 1.**

Carefully inspect the board for shipping damage, loose components, etc, before making connections.

**Step 2.**

Attach the board to the line and load as shown in the diagram. Be sure to check for correct polarity when connecting the LED string to avoid damage to the string. The board is short circuit and open circuit proof. The LED string voltage can be anything between zero and 40V, though performance will suffer when the string voltage is substantially lower than the target of 40V. See the typical performance graphs.

**Step 3.**

Energize the mains supply. The board can be connected to mains directly. Alternatively voltage can be raised gradually from zero to full line voltage with the aid of an adjustable AC supply such as a Variac or a programmable AC source.

**Principles of Operation**

The HV9931 topology can be viewed as a series connection of two basic power supply topologies, (1) a buck-boost stage as first or input stage, for purpose of converting AC line power into a source of DC power, commonly known as the DC bus, having sufficient capacitive energy storage to maintain the bus voltage more or less constant throughout the AC line cycle, and (2) a buck stage as second or output stage for powering the LED string, stepping down the DC bus voltage to the LED string voltage in order to produce a steady LED string current.

The output or buck stage is designed for operation in continuous conduction mode (CCM), operating with about 20 to 30% inductor current ripple. This amount of ripple serves the needs of the HV9931 peak current controller which relies on a sloping inductor current for setting ON time, and is of an acceptable level to high brightness LEDs. Duty cycle is more or less constant throughout the line cycle as the DC bus

voltage and LED string voltage are more or less constant as well. Duty cycle and bus voltage do adjust in response to changes in line or load voltage but are otherwise constant over the course of a line cycle. With the HV9931, OFF time is fixed by design, being programmed by an external resistor, whereas ON time adjusts to a more or less constant value, being under control of the HV9931 peak current regulator.

The input or buck-boost stage is designed for operation in discontinuous conduction mode (DCM) throughout the range of line and load voltage anticipated. This can be accomplished by making the input inductor sufficiently small. A well known property of the DCM buck-boost stage, when operated with constant ON time and constant OFF time, is that input current is proportional to input voltage, whether in peak value or average value. This results in sinusoidal input current when the input voltage is sinusoidal, thereby giving unity power factor operation when operating from the rectified AC line voltage.

When operated in the anticipated range of line and load voltage, the MOSFET ON time will be under control of the output stage current controller, which turns the MOSFET off when sensing that the output inductor current has reached the desired peak current level as programmed by a resistive divider at the CS2 pin. Under certain abnormal circumstances such as initial run-up and line undervoltage, which both could lead to the draw of abnormally high line current, ON time is further curtailed by the action of the CS1 comparator, which monitors the input stage inductor current against a threshold. This threshold can be a simple DC level or be shaped in time as is performed on the Demoboard. In particular, when shaping the CS1 threshold with the shape of the rectified AC line input voltage waveform, the line current will be bounded by a more or less sinusoidal line current envelope which results in sinusoidal input current for low line and other abnormal conditions.

The design exercise of an HV9931 LED driver revolves around establishing component values for (1) the input and output stage inductors, (2) a value for the bus capacitor, and (3) a value for switching cycle OFF time, which together result in (1) acceptable current ripple at the output stage (say 30%), (2) an acceptable bus voltage ripple (say 5%), and (3) an input stage which maintains DCM operation over the desired line and load voltage range.

For a given HV9931 design, the bus voltage rises and falls with like changes in line and load voltage. This is unlike a two stage design having two transistors and control ICs, where the bus voltage can be set independent of line and load voltage variation. If the desired ranges of line and load voltage are particularly large then the latter topology may be preferable so as to avoid large variation in bus voltage.

The design of an HV9931 based LED driver is not further discussed here, except for noting that a semi-automatic design tool is available in Mathcad form, based on behavioral

simulation, which, allows components to be adjusted in an iterative manner, starting from an initial guess. The tool allows quick evaluation of nine standard test cases, exercising the design over line voltage variation and tolerance variation of three component parameters.

Mathcad design data can be found at the end of this document. The data tends to be in good agreement with the actual Demoboard despite the omission of switching losses in the model. For this design we can see that the calculated efficiency is off by say 5 percent likely due underestimation of switching losses and inductor core and winding losses.

## A Simplified Version of the Design

The Demoboard can be simplified significantly. Below is a schematic showing the essential elements of the driver.

Contact Supertex Applications Engineering for guidance in simplifying the design or for adding functions such as triac dimmability.

## Simplified Schematic Diagram

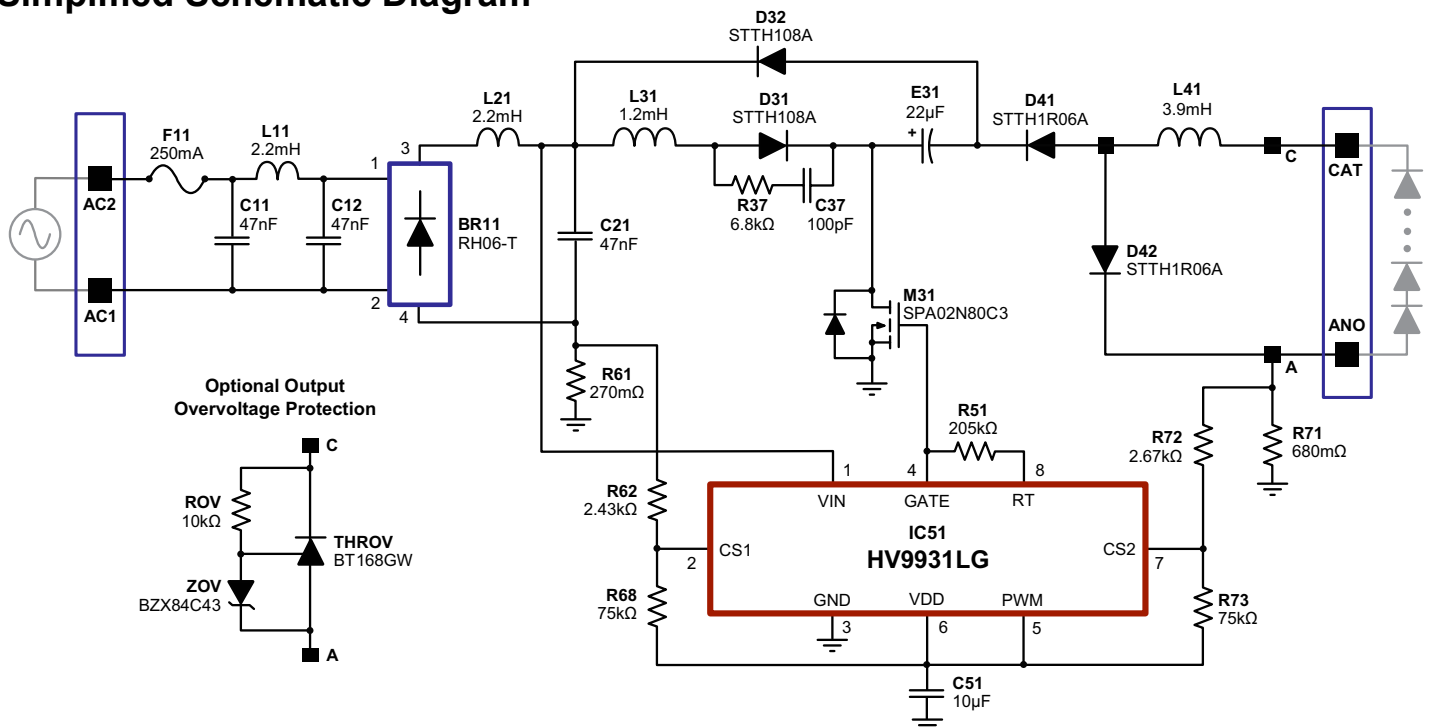

### Note on Inductors:

This board was fitted with standard (COTS) inductors. These are not necessarily an optimal choice but present an expedient way to go when evaluating a design. Custom engineered parts generally give better performance, particularly with respect to efficiency.

Drum core style inductors, whether in radial or axial leaded versions, are popular for their ready availability and low cost. Drum core styles have particularly simple construction and

can be wound for lowest cost without coil former (bobbin). They may serve well during the development stage, but may not be the best choice for final design. Keep these type of inductors away from any metallic surface such as heatsinks, PCB copper planes, metallic enclosures, and capacitors, as these unshielded parts can create high eddy current losses in these parts. For tightly packaged designs or where inductor losses are an issue, drum core style inductors are not recommended.

## Schematic Diagram

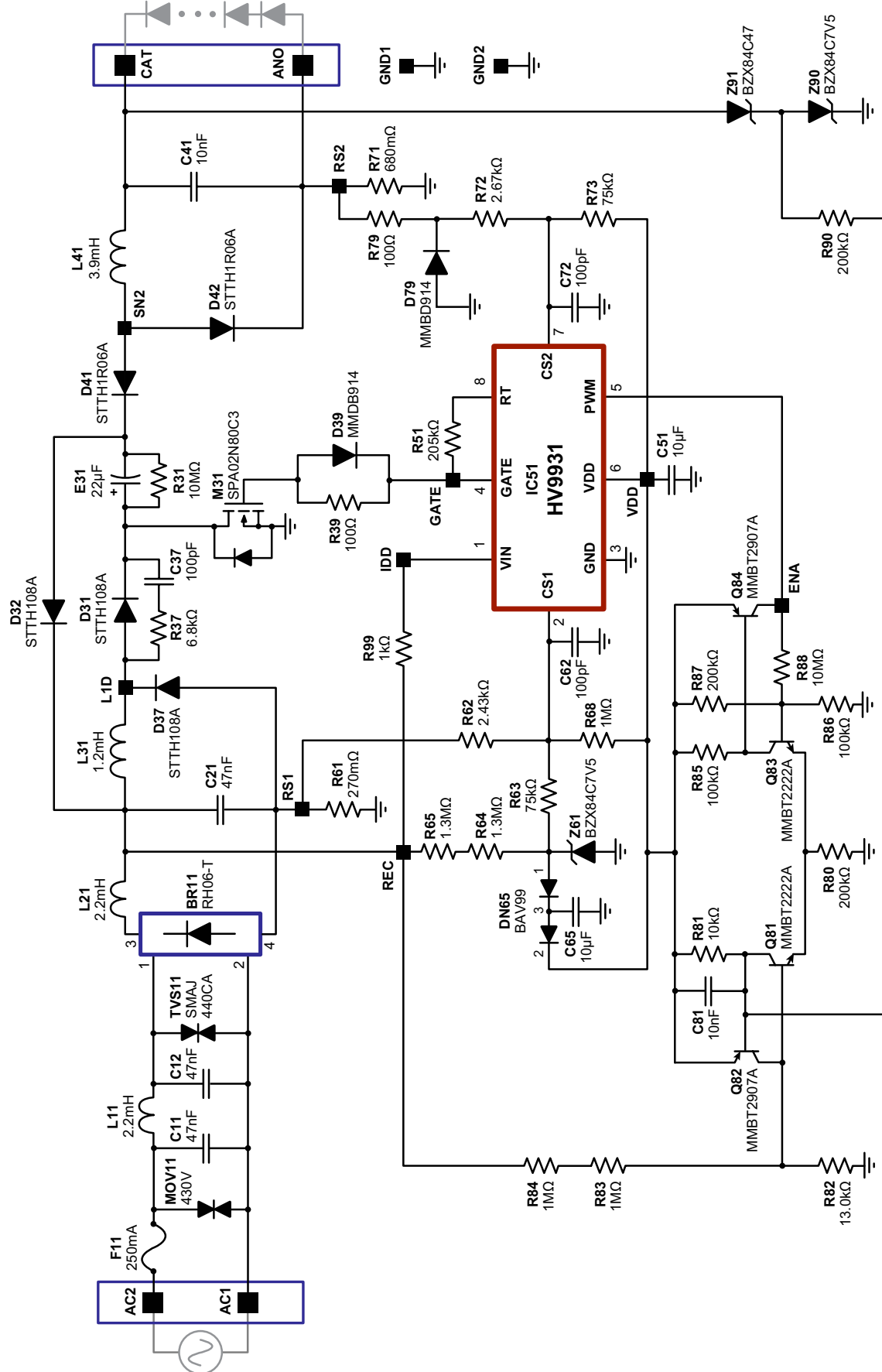

## Typical Characteristics

String Current [mA] vs. String Voltage [V]

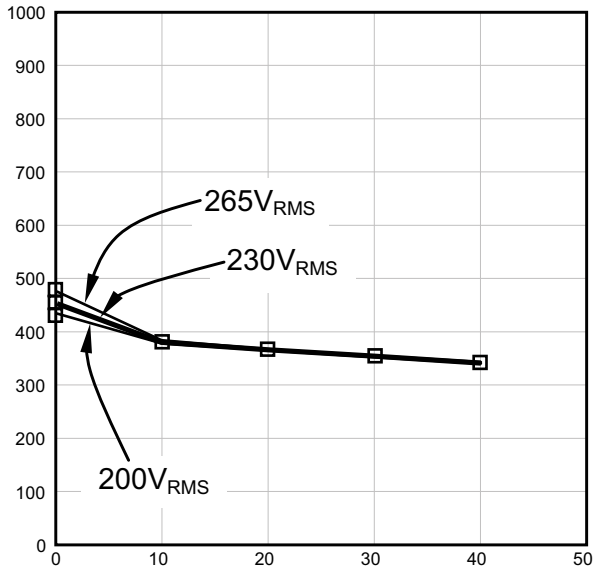

Efficiency [%] vs. String Voltage [V]

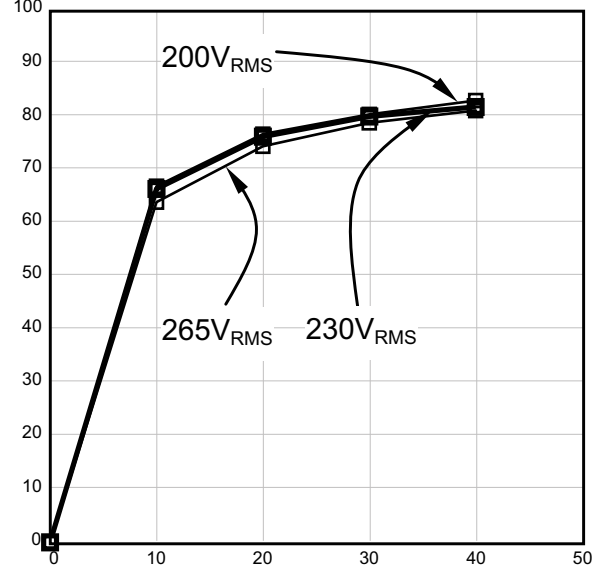

PF [%] vs. String Voltage [V]

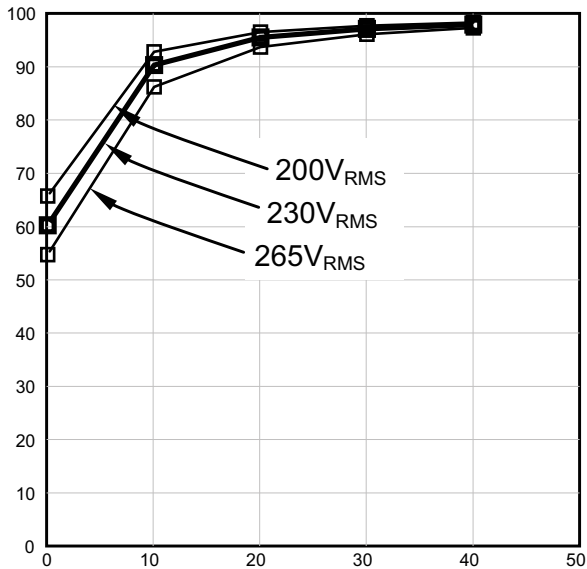

THD [%] vs. String Voltage [V]

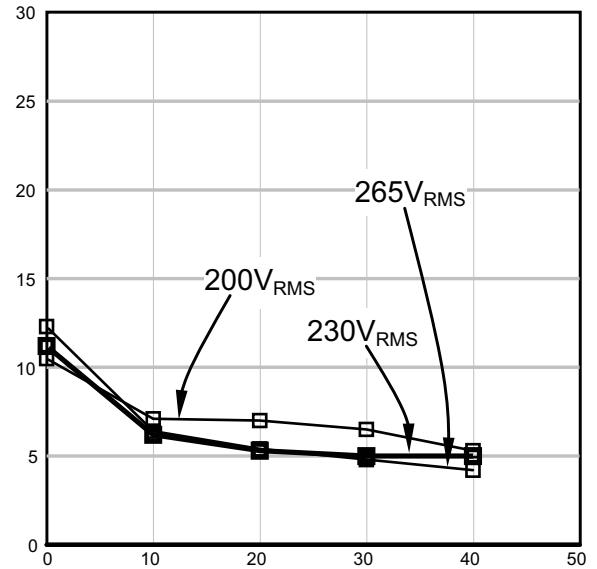

## Typical Waveforms (1)

Line Voltage and Current at nominal load (350mA, 40V)

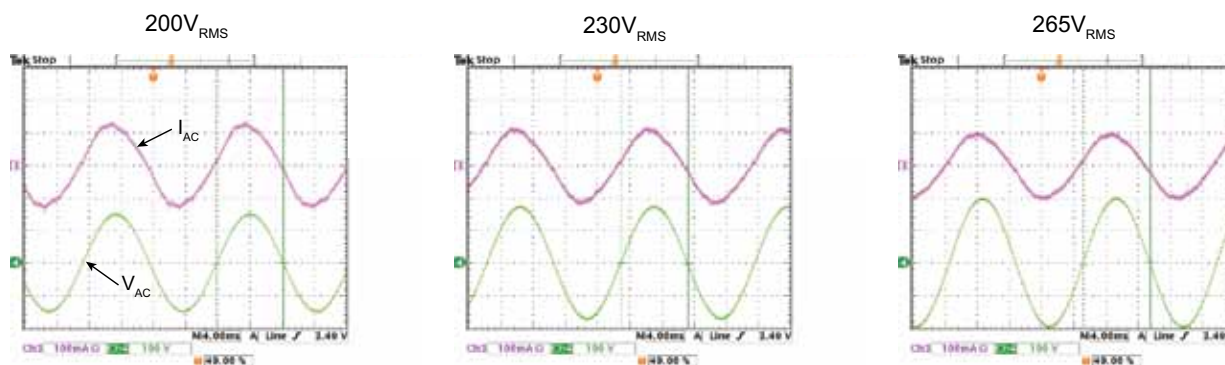

Line Voltage and Current at half load (350mA, 20V)

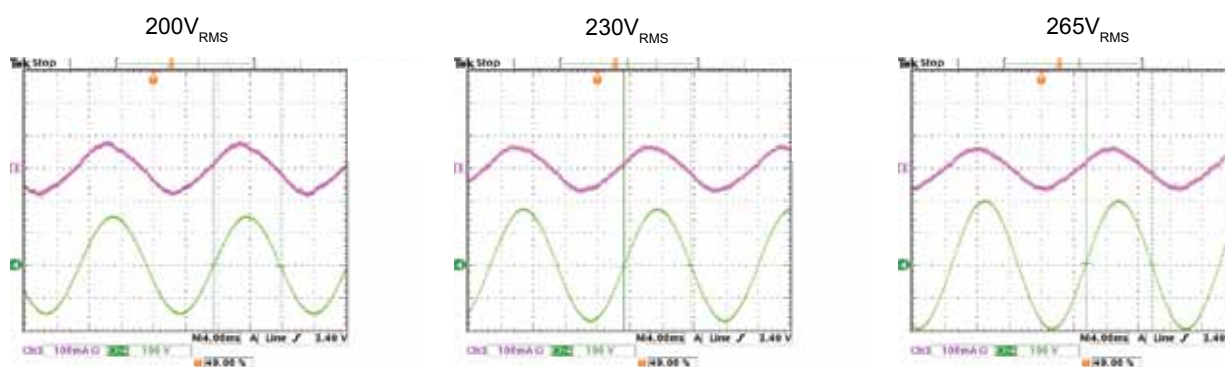

Output Current and Drain Voltage at nominal load (350mA, 40V)

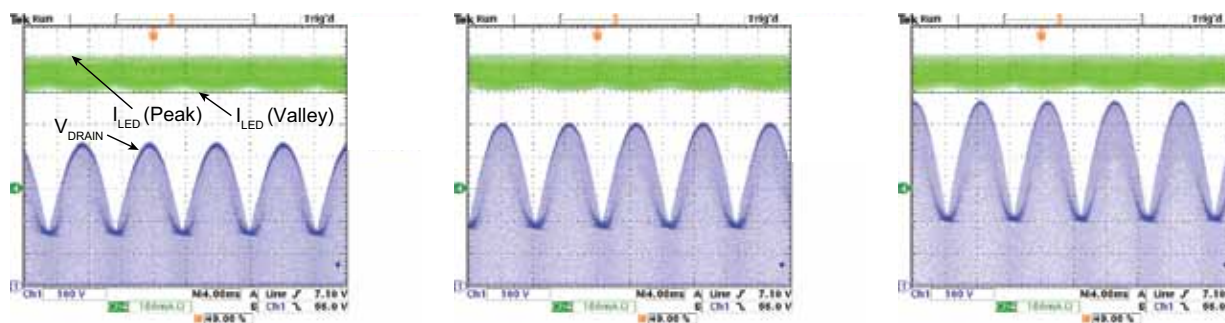

Output Current and Drain Voltage at half load (350mA, 20V)

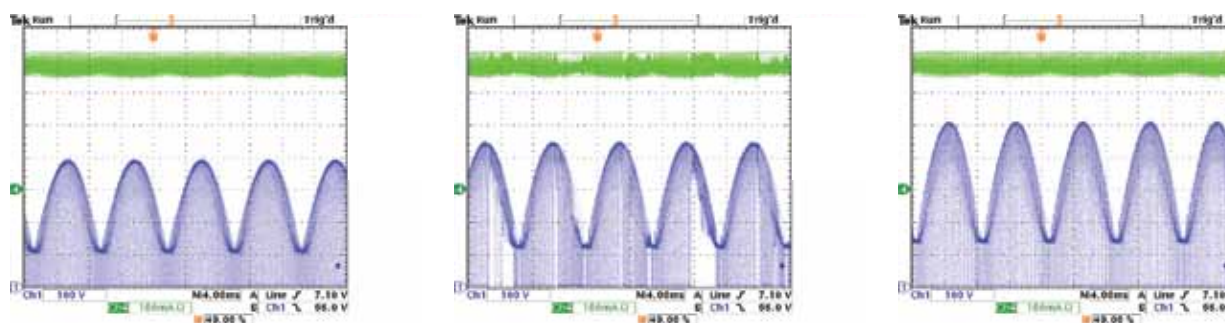

Typical Waveforms (2) (120V<sub>RMS</sub>, 40V, 350mA)

Drain Voltage and LED Current

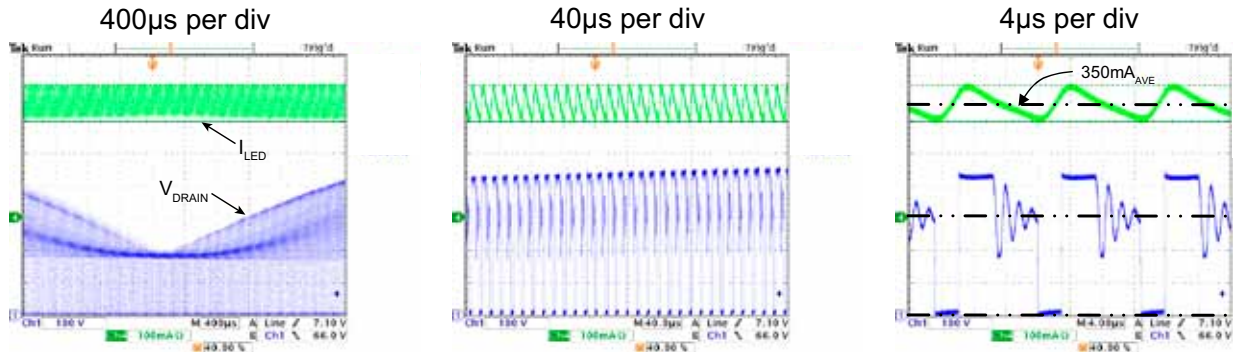

Drain Voltage and Gate Voltage

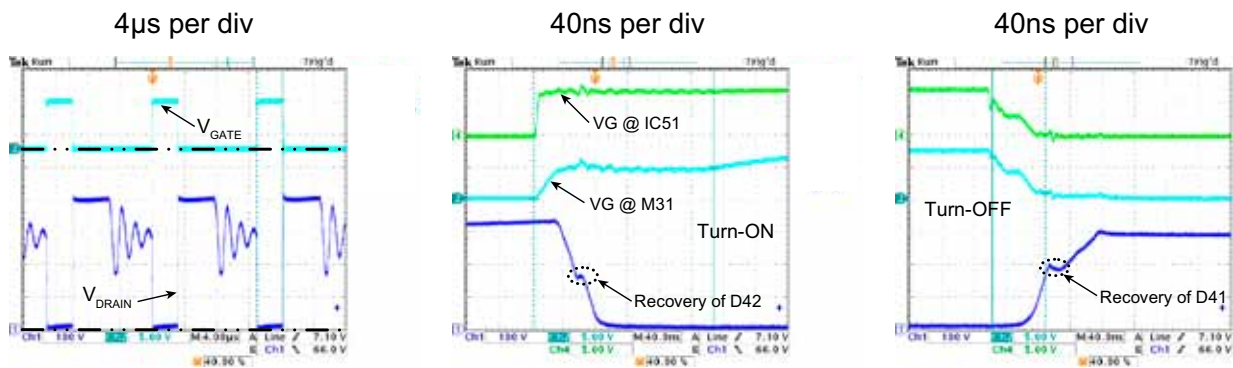

Drain Voltage and Current Sense Voltages of Stages 1 and 2

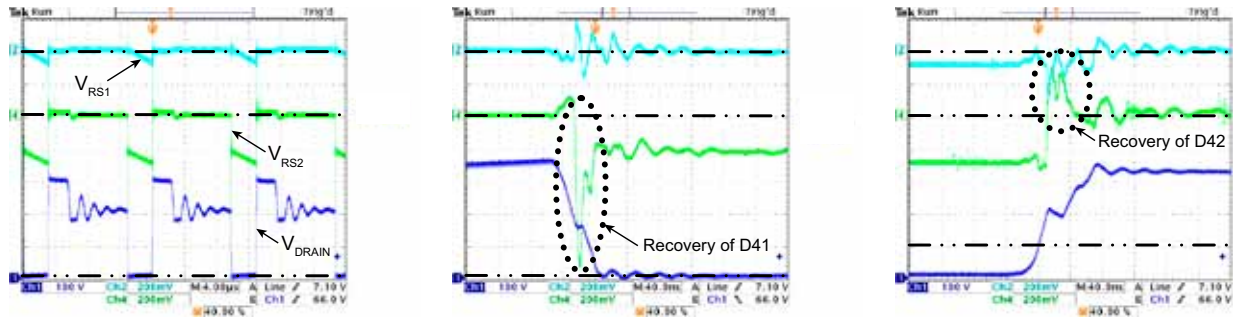

Drain Voltage and Voltages at Test Points REC, SN3, SN2

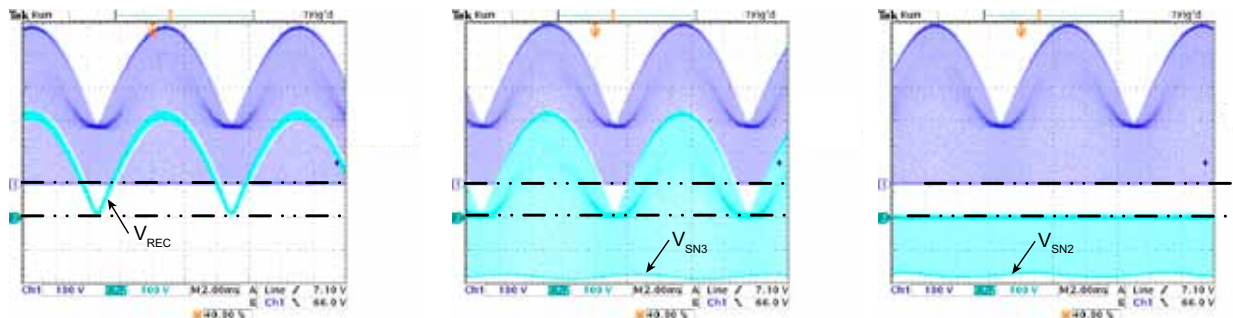

Typical Waveforms (3) ( $120V_{RMS}$ , 40V, 350mA)

Drain Voltage and Voltage at the Test Point L1D (3 points along the AC line cycle)

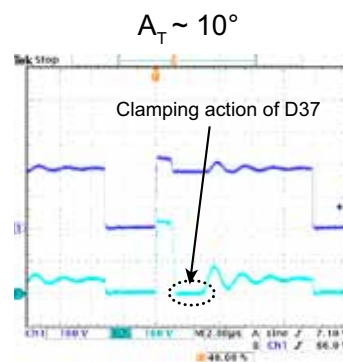
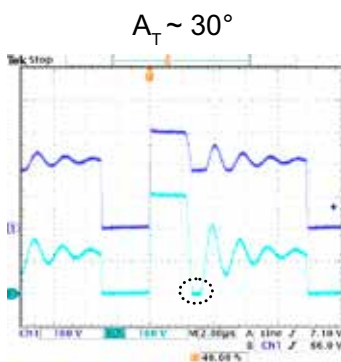
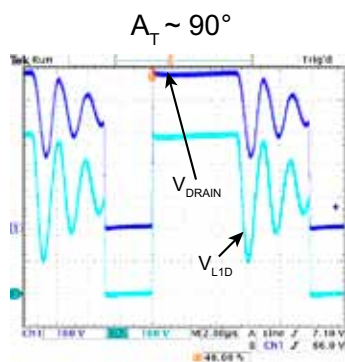



## EMI Signature

Board suspended about 3" above reference plane.

*Limit Line:* CISPR 15 Quasi Peak (9kHz to 30MHz)

*Detector:* Peak Hold

*IF Bandwidth:* 9kHz

*Shielding:* 2 copper shields, surrounding the power section on top and bottom of the board, terminated at the source of the MOSFET.

### Without shielding :

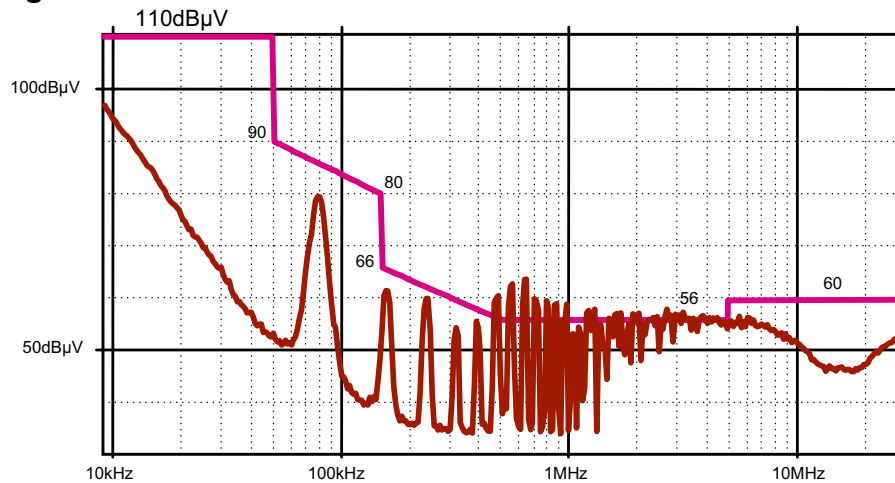

### With shielding :

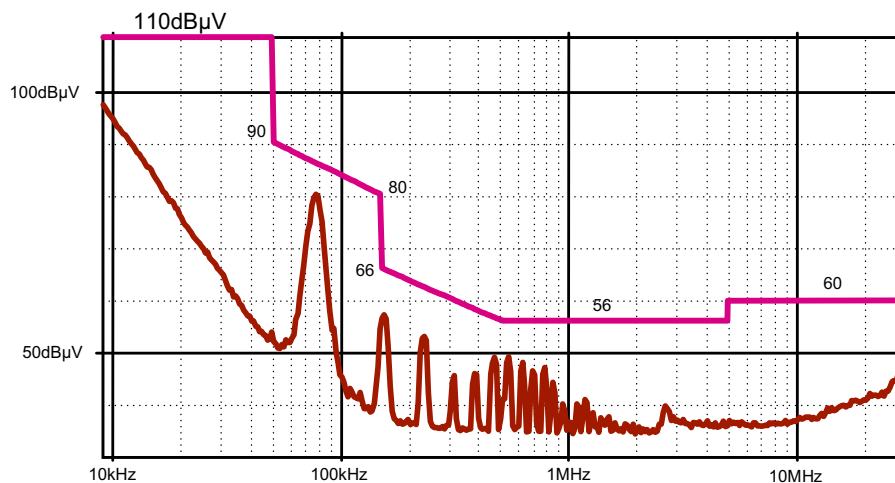

The performance graphs above were obtained from the board not having specific measures to suppress common mode emissions, such as inclusion of a common mode inductor in the AC line input circuitry. The above graphs show how shielding can significantly reduce emissions, particu-

larly in the upper frequency range. The shielding also was instrumental in reducing the lower frequency emissions by reducing magnetic field coupling from the main inductors to the EMI filter inductors (EMI filter section kept outside of shielded area).

## Mathcad Design Data

Corner	x	0	0	1	2	3	4	5	6	7	8	Corner	-	-	-	-
L1	uH	0	1320	1200	1080	1320	1200	1080	1320	1200	1080	L1	-	-	-	-
RL1	mR	0	4400	4400	4400	4400	4400	4400	4400	4400	4400	RL1	-	-	-	-
L2	mH	0	3900	3900	3900	3900	3900	3900	3900	3900	3900	L2	-	-	-	-
RL2	mR	0	3000	3000	3000	3000	3000	3000	3000	3000	3000	RL2	-	-	-	-
ILRF2	%	0	28	28	28	28	28	28	28	28	28	ILRF2	-	-	-	-
C2	uF	0.0	17.6	22.0	26.4	17.6	22.0	26.4	17.6	22.0	26.4	C2	-	-	-	-
NF	x	0	2	2	2	2	2	2	2	2	2	NF	-	-	-	-
LF	uH	0	2200	2200	2200	2200	2200	2200	2200	2200	2200	LF	-	-	-	-
RLF	mR	0	2300	2300	2300	2300	2300	2300	2300	2300	2300	RLF	-	-	-	-
CF	nF	0	47	47	47	47	47	47	47	47	47	CF	-	-	-	-
C1	nF	0	47	47	47	47	47	47	47	47	47	C1	-	C2V	135	-
RS	mR	0	1000	1000	1000	1000	1000	1000	1000	1000	1000	RS	-	C2I	1345	-
VD	mV	0	1500	1500	1500	1500	1500	1500	1500	1500	1500	VD	-	-	-	-
TF	us	0.0	9.1	9.1	9.1	9.1	9.1	9.1	9.1	9.1	9.1	TF	-	-	-	-
RT	kR	0	205	205	205	205	205	205	205	205	205	RT	-	-	-	-
FM	Hz	0	50	50	50	50	50	50	50	50	50	FM	-	-	-	-
VMRMS	V	0	200	200	200	230	230	230	265	265	265	VMRMS	-	-	-	-
IMRMS	mA	0	84	81	78	73	70	68	63	61	59	IMRMS	68	73	59	84
IMMAX	mA	0	125	117	112	107	101	98	92	88	84	IMMAX	98	107	84	125
V3AVG	V	0	40	40	40	40	40	40	40	40	40	V3AVG	40	40	40	40
I3AVG	mA	0	360	350	340	360	350	340	360	350	340	I3AVG	340	360	340	360
PM	W	0.0	16.4	16.0	15.4	16.3	15.8	15.4	16.2	15.7	15.2	PM	15.4	16.3	15.2	16.4
P3	W	0.0	14.4	14.0	13.6	14.4	14.0	13.6	14.4	14.0	13.6	P3	13.6	14.4	13.6	14.4
EFF	%	0.0	87.8	87.8	88.3	88.5	88.7	88.3	88.8	89.4	89.4	EFF	88.3	88.7	87.8	89.4
PF	%	0.0	97.6	98.6	99.0	97.6	98.3	98.6	97.1	97.6	97.7	PF	97.6	98.6	97.1	99.0
THD	%	0.0	9.9	5.7	3.6	7.6	4.5	2.9	5.9	3.6	2.5	THD	2.9	7.6	2.5	9.9
H3	%	0.0	9.7	5.6	3.5	7.5	4.3	2.7	5.8	3.4	2.2	H3	2.7	7.5	2.2	9.7
H5	%	0.0	1.8	0.9	0.6	1.2	0.7	0.5	0.9	0.5	0.5	H5	0.5	1.2	0.5	1.8
TAMIN	us	0.0	3.1	3.3	3.4	2.7	2.8	2.9	2.3	2.4	2.5	TAMIN	2.7	2.9	2.3	3.4
TAMAX	us	0.0	4.0	3.8	3.7	3.2	3.1	3.1	2.6	2.6	2.6	TAMAX	3.1	3.2	2.6	4.0
TFMIN	us	0.0	7.3	9.1	10.9	7.3	9.1	10.9	7.3	9.1	10.9	TFMIN	7.3	10.9	7.3	10.9
TFMAX	us	0.0	7.3	9.1	10.9	7.3	9.1	10.9	7.3	9.1	10.9	TFMAX	7.3	10.9	7.3	10.9
DAMIN	%	0.0	30.0	26.8	23.7	27.0	23.8	21.1	24.2	21.1	18.6	DAMIN	21.1	27.0	18.6	30.0
DAMAX	%	0.0	35.3	29.5	25.2	30.7	25.7	22.1	26.7	22.4	19.2	DAMAX	22.1	30.7	19.2	35.3

## Mathcad Design Data (cont.)

Corner	x	0	0	1	2	3	4	5	6	7	8	Corner	-	-	-	-
DC1MAX	%	0.0	99.0	77.6	62.0	88.9	69.3	55.5	79.7	61.6	49.0	DC1MAX	55.5	88.9	49.0	99.0
FSMIN	kHz	0.0	89.0	77.7	68.7	95.4	81.9	71.5	100.9	85.5	74.1	FSMIN	71.5	95.4	68.7	100.9
FSMAX	kHz	0.0	96.3	80.7	70.0	100.5	83.9	72.4	104.4	86.9	74.7	FSMAX	72.4	100.5	70.0	104.4
IL1RMS	mA	0	275	275	273	254	253	254	235	234	234	IL1RMS	253	254	234	275
IL1MAX	mA	0	723	810	897	702	789	883	686	772	864	IL1MAX	702	883	686	897
IL2RMS	mA	0	361	351	342	361	351	342	361	351	342	IL2RMS	342	361	342	361
IL2MAX	mA	0	400	400	400	400	400	400	400	400	400	IL2MAX	400	400	400	400
I2RMS	mA	0	300	282	266	280	263	249	262	245	231	I2RMS	249	280	231	300
V2MIN	V	0	121	145	170	139	166	193	160	191	222	V2MIN	139	193	121	222
V2MAX	V	0	142	160	180	158	179	202	177	202	230	V2MAX	158	202	142	230
V2RELPPR	%	0.0	16.0	9.5	5.8	12.6	7.3	4.6	10.0	5.7	3.5	V2RELPPR	5	13	4	16
ISRMS	mA	0	354	343	333	329	318	310	306	295	287	ISRMS	310	329	287	354
ISMAX	mA	0	1122	1209	1296	1101	1189	1282	1085	1172	1263	ISMAX	1101	1282	1085	1296
VSMAX	V	0	415	433	455	473	496	520	542	568	597	VSMAX	473	520	415	597
IDL1AVG	mA	0	191	170	152	167	148	134	147	129	116	IDL1AVG	134	167	116	191
IDF1AVG	mA	0	117	98	83	103	87	74	92	76	65	IDF1AVG	74	103	65	117
IDR2AVG	mA	0	117	98	83	103	86	73	91	76	64	IDR2AVG	73	103	64	117
IDF2AVG	mA	0	243	252	257	257	264	267	269	274	276	IDF2AVG	257	267	243	276
IRS1RMS	mA	0	167	174	180	153	160	167	141	146	153	IRS1RMS	153	167	141	180
IRS2RMS	mA	0	205	186	169	193	175	159	182	164	149	IRS2RMS	159	193	149	205

## Simulated Waveforms (Mathcad)

Corner 0 (100V<sub>AC</sub>) (High Duty)

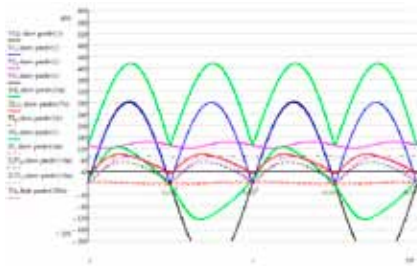

Corner 1 (100V<sub>AC</sub>) (Nom Duty)

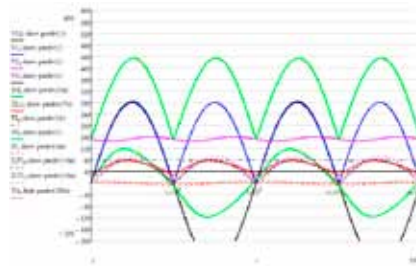

Corner 2 (100V<sub>AC</sub>) (Low Duty)

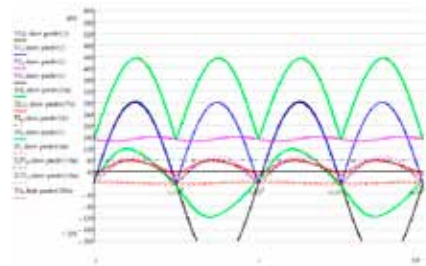

Corner 3 (120V<sub>AC</sub>) (High Duty)

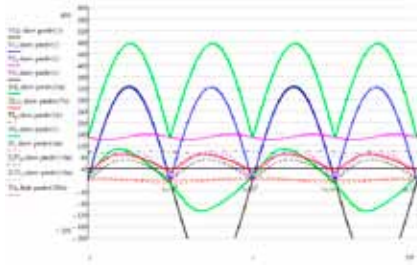

Corner 4 (120V<sub>AC</sub>) (Nom Duty)

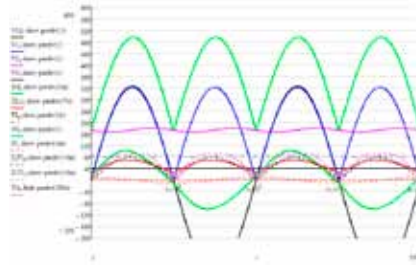

Corner 5 (120V<sub>AC</sub>) (Low Duty)

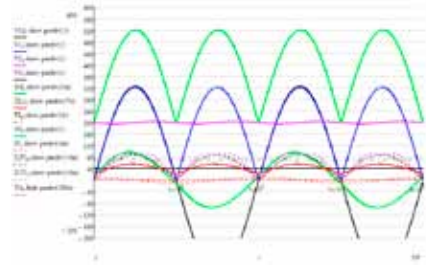

Corner 6 (135V<sub>AC</sub>) (High Duty)

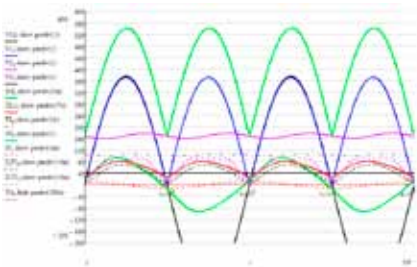

Corner 7 (135V<sub>AC</sub>) (Nom Duty)

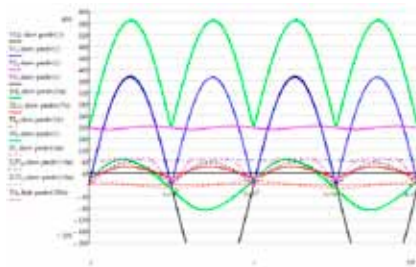

Corner 8 (135V<sub>AC</sub>) (Low Duty)

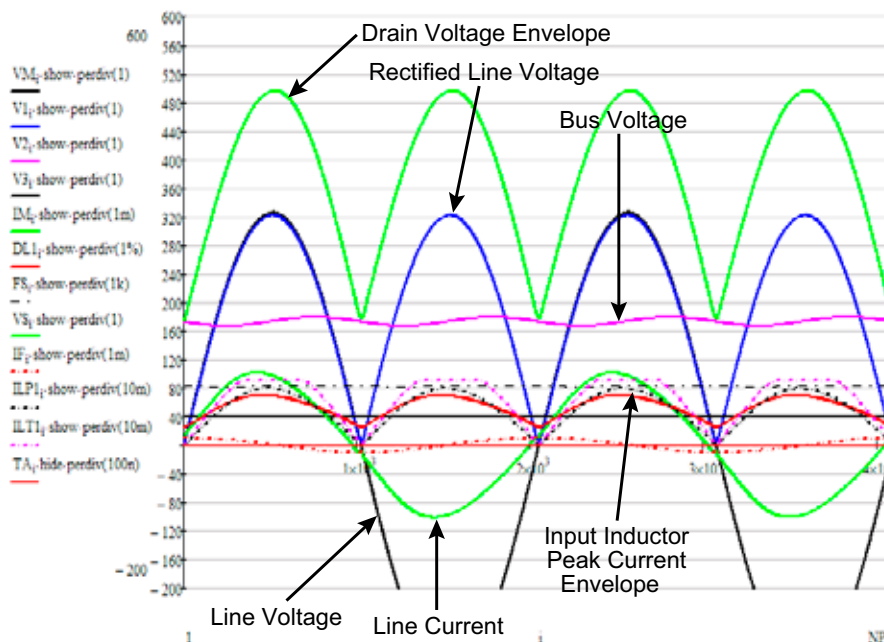
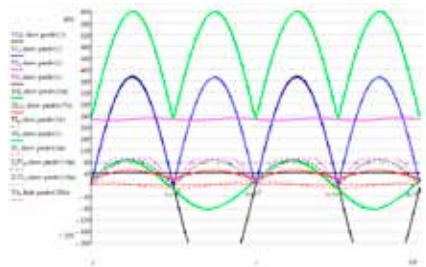

## Bill of Materials

Qty	REF	Description	Manufacturer	Product Number
1	BR11	RECT BRIDGE GP MINIDIP 600V 0.5A	Diodes Inc	RH06-T
2	C62, C72	CAP CER NP0 50V 10% 0805 100PF	Kemet	C0805C101K5GACTU
2	C41, C81	CAP CER X7R 100V 10% 0805 10NF	Kemet	C0805C103K1RACTU
1	C37	CAP CER NP0 1000V 5% 0805 100PF	Vishay/Vitramon	VJ0805A101JXGAT5Z
2	C51, C65	CAP CER X7R 16V 10% 1206 10µF	Murata	GRM31CR71C106KAC7L
3	C11, C12, C21	CAP MKP 305VAC X2 125C 20% 47NF	EPCOS Inc	B32921A2473M
3	D31, D32, D37	DIODE ULTRAFAST 800V 1A SMA	STMicroelectronics	STTH108A
2	D41, D42	DIODE ULTRAFAST 600V 1A SMA	STMicroelectronics	STTH1R06A
2	D39, D79	DIODE ULTRAFAST HI COND SOT-23	Fairchild Semiconductor	MMBD914
1	DN65	DIODE SW DUAL 75V 350MW SOT23	Diodes Inc	BAV99-7-F
1	E31	CAP ALEL ED RAD10X20 250V 20% 22µF	Panasonic ECG	EEU-ED2E220
1	F11	FUSE SLOW IEC TR5 250MA	Littelfuse Wickmann	37202500411
1	HS	HEATSINK TO220 W/TAB W86 D40 H75 21K	Aavid Thermalloy	574502B03700G
1	IC51	IC LED DRIVER 8L SOIC	Supertex	HV9931LG-G
2	L11, L21	CHOKE SH RAD13MM 15% 2.2MH 520MA	Sumida	RCP1317NP-222L
1	L31	CHOKE RAD 450D 710L 10% 1200µH	Renco	RL-5480-4-1200
1	L41	CHOKE RAD 625D 700L 10% 3.9MH	Renco	RL-5480-5-3900
1	M31	MOSFET N-CH 800V 2A 2.7R TO-220FP	Infineon Technologies	SPA02N80C3
1	MOV11	SUR ABSORBER 10MM 430VDC 2500A ZNR	Panasonic ECG	ERZ-V10D431
2	Q81, Q83	TRANSISTOR GP NPN AMP SOT-23	Fairchild Semiconductor	MMBT2222A
2	Q82, Q84	TRANSISTOR GP PNP AMP SOT-23	Fairchild Semiconductor	MMBT2907A
1	R99	RES 1/8W 0805 1% 1.00KΩ	Panasonic ECG	ERJ-6ENF1001V
2	R39, R79	RES 1/8W 0805 1% 100Ω	Panasonic ECG	ERJ-6ENF1000V
1	R62	RES 1/8W 0805 1% 2.43KΩ	Panasonic ECG	ERJ-6ENF2431V
1	R72	RES 1/8W 0805 1% 2.67KΩ	Panasonic ECG	ERJ-6ENF2671V
1	R81	RES 1/8W 0805 1% 10.0KΩ	Panasonic ECG	ERJ-6ENF1002V
1	R82	RES 1/8W 0805 1% 13.0KΩ	Panasonic ECG	ERJ-6ENF1302V
1	R63, R73	RES 1/8W 0805 1% 75.0KΩ	Panasonic ECG	ERJ-6ENF7502V
2	R85, R86	RES 1/8W 0805 1% 100KΩ	Panasonic ECG	ERJ-6ENF1003V
1	R51	RES 1/8W 0805 1% 205KΩ	Panasonic ECG	ERJ-6ENF2053V
3	R80, R87, R90	RES 1/8W 0805 1% 200KΩ	Panasonic ECG	ERJ-6ENF2003V
2	R64, R65	RES 1/8W 0805 1% 1.30MΩ	Panasonic ECG	ERJ-6ENF1304V
3	R68, R83, R84	RES 1/8W 0805 1% 1.00MΩ	Panasonic ECG	ERJ-6ENF1004V
1	R88	RES 1/8W 0805 1% 10.0MΩ	Vishay/Dale	CRCW080510M0FKEA

## Bill of Materials (cont.)

Qty	REF	Description	Manufacturer	Product Number
1	R37	RES 1/4W 1206 5% 6.8K $\Omega$	Panasonic ECG	ERJ-8GEYJ682V
1	R31	RES 1/4W 1206 1% 10.0M $\Omega$	Vishay/Dale	CRCW120610M0FKEA
1	R61	RES 1/4W 0805 1% .27 $\Omega$	Susumu Co Ltd	RL1220S-R27-F
1	R71	RES 1/4W 0805 1% .68 $\Omega$	Susumu Co Ltd	RL1220S-R68-F
1	TVS11	DIODE TVS BIDIR SMA 400W 5% 440V	Littelfuse Inc	SMAJ440CA
2	Z61, Z90	DIODE ZENER 350MW SOT-23 7.5V	Diodes Inc	BZX84C7V5-7-F
1	Z91	DIODE ZENER 350MW SOT-23 47V	Diodes Inc	BZX84C47-7-F

**Supertex inc.** does not recommend the use of its products in life support applications, and will not knowingly sell them for use in such applications unless it receives an adequate "product liability indemnification insurance agreement." **Supertex inc.** does not assume responsibility for use of devices described, and limits its liability to the replacement of the devices determined defective due to workmanship. No responsibility is assumed for possible omissions and inaccuracies. Circuitry and specifications are subject to change without notice. For the latest product specifications refer to the **Supertex inc.** (website: <http://www.supertex.com>)

Компания «Life Electronics» занимается поставками электронных компонентов импортного и отечественного производства от производителей и со складов крупных дистрибьюторов Европы, Америки и Азии.

С конца 2013 года компания активно расширяет линейку поставок компонентов по направлению коаксиальный кабель, кварцевые генераторы и конденсаторы (керамические, пленочные, электролитические), за счёт заключения дистрибьюторских договоров

Мы предлагаем:

- Конкурентоспособные цены и скидки постоянным клиентам.
- Специальные условия для постоянных клиентов.
- Подбор аналогов.
- Поставку компонентов в любых объемах, удовлетворяющих вашим потребностям.
- Приемлемые сроки поставки, возможна ускоренная поставка.
- Доставку товара в любую точку России и стран СНГ.
- Комплексную поставку.
- Работу по проектам и поставку образцов.
- Формирование склада под заказчика.
- Сертификаты соответствия на поставляемую продукцию (по желанию клиента).
- Тестирование поставляемой продукции.
- Поставку компонентов, требующих военную и космическую приемку.
- Входной контроль качества.
- Наличие сертификата ISO.

В составе нашей компании организован Конструкторский отдел, призванный помогать разработчикам, и инженерам.

Конструкторский отдел помогает осуществить:

- Регистрацию проекта у производителя компонентов.
- Техническую поддержку проекта.
- Защиту от снятия компонента с производства.
- Оценку стоимости проекта по компонентам.
- Изготовление тестовой платы монтаж и пусконаладочные работы.



Тел: +7 (812) 336 43 04 (многоканальный)  
Email: [org@lifeelectronics.ru](mailto:org@lifeelectronics.ru)