



Intel® Xeon® Processor E5-1600/ E5-2600/E5-4600 Product Families

Datasheet - Volume One

May 2012



INFORMATION IN THIS DOCUMENT IS PROVIDED IN CONNECTION WITH INTEL PRODUCTS. NO LICENSE, EXPRESS OR IMPLIED, BY ESTOPPEL OR OTHERWISE, TO ANY INTELLECTUAL PROPERTY RIGHTS IS GRANTED BY THIS DOCUMENT. EXCEPT AS PROVIDED IN INTEL'S TERMS AND CONDITIONS OF SALE FOR SUCH PRODUCTS, INTEL ASSUMES NO LIABILITY WHATSOEVER AND INTEL DISCLAIMS ANY EXPRESS OR IMPLIED WARRANTY, RELATING TO SALE AND/OR USE OF INTEL PRODUCTS INCLUDING LIABILITY OR WARRANTIES RELATING TO FITNESS FOR A PARTICULAR PURPOSE, MERCHANTABILITY, OR INFRINGEMENT OF ANY PATENT, COPYRIGHT OR OTHER INTELLECTUAL PROPERTY RIGHT.

UNLESS OTHERWISE AGREED IN WRITING BY INTEL, THE INTEL PRODUCTS ARE NOT DESIGNED NOR INTENDED FOR ANY APPLICATION IN WHICH THE FAILURE OF THE INTEL PRODUCT COULD CREATE A SITUATION WHERE PERSONAL INJURY OR DEATH MAY OCCUR.

Intel may make changes to specifications and product descriptions at any time, without notice. Designers must not rely on the absence or characteristics of any features or instructions marked "reserved" or "undefined." Intel reserves these for future definition and shall have no responsibility whatsoever for conflicts or incompatibilities arising from future changes to them. The information here is subject to change without notice. Do not finalize a design with this information.

The Intel® Xeon® Processor E5-1600/ E5-2600/E5-4600 Product Families, Intel® C600 series chipset, and the Intel® Xeon® Processor E5-1600/ E5-2600/E5-4600 Product Families-based Platform described in this document may contain design defects or errors known as errata which may cause the product to deviate from published specifications. Current characterized errata are available on request.

Contact your local Intel sales office or your distributor to obtain the latest specifications and before placing your product order.

Copies of documents which have an order number and are referenced in this document, or other Intel literature, may be obtained by calling 1-800-548-4725, or go to: http://www.intel.com/#/en_US_01

Hyper-Threading Technology requires a computer system with a processor supporting HT Technology and an HT Technology enabled chipset, BIOS and operating system. Performance will vary depending on the specific hardware and software you use. For more information including details on which processors support HT Technology, see http://www.intel.com/products/ht/hyperthreading_more.htm.

Enabling Execute Disable Bit functionality requires a PC with a processor with Execute Disable Bit capability and a supporting operating system. Check with your PC manufacturer on whether your system delivers Execute Disable Bit functionality.

Intel® Virtualization Technology requires a computer system with an enabled Intel® processor, BIOS, virtual machine monitor (VMM) and, for some uses, certain computer system software enabled for it. Functionality, performance or other benefits will vary depending on hardware and software configurations and may require a BIOS update. Software applications may not be compatible with all operating systems. Please check with your application vendor.

Intel® Turbo Boost Technology requires a PC with a processor with Intel Turbo Boost Technology capability. Intel Turbo Boost Technology performance varies depending on hardware, software and overall system configuration. Check with your PC manufacturer on whether your system delivers Intel Turbo Boost Technology. For more information, see <http://www.intel.com/technology/turboboost/>.

64-bit computing on Intel architecture requires a computer system with a processor, chipset, BIOS, operating system, device drivers and applications enabled for Intel® 64 architecture. Performance will vary depending on your hardware and software configurations. Consult with your system vendor for more information.

Δ Intel processor numbers are not a measure of performance. Processor numbers differentiate features within each processor family, not across different processor families. See <http://www.intel.com/products/processor%5Fnumber/> for details.

I²C is a two-wire communications bus/protocol developed by Philips. SMBus is a subset of the I²C bus/protocol and was developed by Intel. Implementations of the I²C bus/protocol may require licenses from various entities, including Philips Electronics N.V. and North American Philips Corporation.

Intel, Xeon, Intel SpeedStep, Intel Core, and the Intel logo are trademarks of Intel Corporation in the U. S. and other countries.

*Other names and brands may be claimed as the property of others.

Copyright © 2009-2012, Intel Corporation. All rights reserved.



Contents

1	Overview	13
1.1	Introduction	13
1.1.1	Processor Feature Details	14
1.1.2	Supported Technologies	14
1.2	Interfaces	15
1.2.1	System Memory Support	15
1.2.2	PCI Express*	16
1.2.3	Direct Media Interface Gen 2 (DMI2)	17
1.2.4	Intel® QuickPath Interconnect (Intel® QPI)	18
1.2.5	Platform Environment Control Interface (PECI)	18
1.3	Power Management Support	19
1.3.1	Processor Package and Core States	19
1.3.2	System States Support	19
1.3.3	Memory Controller	19
1.3.4	PCI Express	19
1.3.5	Intel QPI	19
1.4	Thermal Management Support	19
1.5	Package Summary	20
1.6	Terminology	20
1.7	Related Documents	22
1.8	State of Data	23
2	Interfaces	25
2.1	System Memory Interface	25
2.1.1	System Memory Technology Support	25
2.1.2	System Memory Timing Support	25
2.2	PCI Express* Interface	26
2.2.1	PCI Express* Architecture	26
2.2.2	PCI Express* Configuration Mechanism	27
2.3	DMI2/PCI Express* Interface	28
2.3.1	DMI2 Error Flow	28
2.3.2	Processor/PCH Compatibility Assumptions	28
2.3.3	DMI2 Link Down	28
2.4	Intel QuickPath Interconnect	28
2.5	Platform Environment Control Interface (PECI)	30
2.5.1	PECI Client Capabilities	30
2.5.2	Client Command Suite	31
2.5.3	Client Management	69
2.5.4	Multi-Domain Commands	74
2.5.5	Client Responses	75
2.5.6	Originator Responses	76
2.5.7	DTS Temperature Data	76
3	Technologies	79
3.1	Intel® Virtualization Technology (Intel® VT)	79
3.1.1	Intel VT-x Objectives	79
3.1.2	Intel VT-x Features	80
3.1.3	Intel VT-d Objectives	80
3.1.4	Intel Virtualization Technology Processor Extensions	81
3.2	Security Technologies	81
3.2.1	Intel® Trusted Execution Technology	81
3.2.2	Intel Trusted Execution Technology – Server Extensions	82
3.2.3	Intel® Advanced Encryption Standard Instructions (Intel® AES-NI)	82



3.2.4	Execute Disable Bit	83
3.3	Intel® Hyper-Threading Technology	83
3.4	Intel® Turbo Boost Technology	83
3.4.1	Intel® Turbo Boost Operating Frequency	83
3.5	Enhanced Intel SpeedStep® Technology	84
3.6	Intel® Intelligent Power Technology	84
3.7	Intel® Advanced Vector Extensions (Intel® AVX)	84
3.8	Intel Dynamic Power Technology	85
4	Power Management	87
4.1	ACPI States Supported	87
4.1.1	System States	87
4.1.2	Processor Package and Core States	87
4.1.3	Integrated Memory Controller States	88
4.1.4	DMI2/PCI Express* Link States	89
4.1.5	Intel QuickPath Interconnect States	89
4.1.6	G, S, and C State Combinations	90
4.2	Processor Core/Package Power Management	90
4.2.1	Enhanced Intel SpeedStep Technology	90
4.2.2	Low-Power Idle States	91
4.2.3	Requesting Low-Power Idle States	92
4.2.4	Core C-states	92
4.2.5	Package C-States	94
4.2.6	Package C-State Power Specifications	97
4.3	System Memory Power Management	98
4.3.1	CKE Power-Down	98
4.3.2	Self Refresh	98
4.3.3	DRAM I/O Power Management	99
4.4	DMI2/PCI Express* Power Management	99
5	Thermal Management Specifications	101
5.1	Package Thermal Specifications	101
5.1.1	Thermal Specifications	101
5.1.2	TCASE and DTS Based Thermal Specifications	103
5.1.3	Processor Thermal Profiles	104
5.1.4	Embedded Server Processor Thermal Profiles	130
5.1.5	Thermal Metrology	133
5.2	Processor Core Thermal Features	135
5.2.1	Processor Temperature	135
5.2.2	Adaptive Thermal Monitor	135
5.2.3	On-Demand Mode	137
5.2.4	PROCHOT_N Signal	137
5.2.5	THERMTRIP_N Signal	138
5.2.6	Integrated Memory Controller (IMC) Thermal Features	138
6	Signal Descriptions	141
6.1	System Memory Interface Signals	141
6.2	PCI Express* Based Interface Signals	142
6.3	DMI2/PCI Express* Port 0 Signals	144
6.4	Intel QuickPath Interconnect Signals	144
6.5	PECI Signal	145
6.6	System Reference Clock Signals	145
6.7	JTAG and TAP Signals	145
6.8	Serial VID Interface (SVID) Signals	146
6.9	Processor Asynchronous Sideband and Miscellaneous Signals	146
6.10	Processor Power and Ground Supplies	149



7	Electrical Specifications	151
7.1	Processor Signaling	151
7.1.1	System Memory Interface Signal Groups	151
7.1.2	PCI Express* Signals	151
7.1.3	DMI2/PCI Express* Signals	151
7.1.4	Intel QuickPath Interconnect (Intel QPI)	151
7.1.5	Platform Environmental Control Interface (PECI)	152
7.1.6	System Reference Clocks (BCLK{0/1}_DP, BCLK{0/1}_DN)	152
7.1.7	JTAG and Test Access Port (TAP) Signals	153
7.1.8	Processor Sideband Signals	153
7.1.9	Power, Ground and Sense Signals	153
7.1.10	Reserved or Unused Signals	158
7.2	Signal Group Summary	158
7.3	Power-On Configuration (POC) Options	162
7.4	Fault Resilient Booting (FRB)	163
7.5	Mixing Processors	163
7.6	Flexible Motherboard Guidelines (FMB)	164
7.7	Absolute Maximum and Minimum Ratings	164
7.7.1	Storage Conditions Specifications	165
7.8	DC Specifications	166
7.8.1	Voltage and Current Specifications	167
7.8.2	Die Voltage Validation	173
7.8.3	Signal DC Specifications	174
7.9	Waveforms	180
7.10	Signal Quality	181
7.10.1	DDR3 Signal Quality Specifications	182
7.10.2	I/O Signal Quality Specifications	182
7.10.3	Intel QuickPath Interconnect Signal Quality Specifications	182
7.10.4	Input Reference Clock Signal Quality Specifications	182
7.10.5	Overshoot/Undershoot Tolerance	182
8	Processor Land Listing	187
8.1	Listing by Land Name	187
8.2	Listing by Land Number	212
9	Package Mechanical Specifications	237
9.1	Package Mechanical Drawing	237
9.2	Processor Component Keep-Out Zones	241
9.3	Package Loading Specifications	241
9.4	Package Handling Guidelines	241
9.5	Package Insertion Specifications	241
9.6	Processor Mass Specification	242
9.7	Processor Materials	242
9.8	Processor Markings	242
10	Boxed Processor Specifications	243
10.1	Introduction	243
10.1.1	Available Boxed Thermal Solution Configurations	243
10.1.2	Intel Thermal Solution STS200C (Passive/Active Combination Heat Sink Solution)	243
10.1.3	Intel Thermal Solution STS200P and STS200PNRW (Boxed 25.5 mm Tall Passive Heat Sink Solutions)	244
10.2	Mechanical Specifications	245
10.2.1	Boxed Processor Heat Sink Dimensions and Baseboard Keepout Zones	245
10.2.2	Boxed Processor Retention Mechanism and Heat Sink Support (ILM-RS)	254
10.3	Fan Power Supply [STS200C]	254
10.3.1	Boxed Processor Cooling Requirements	255
10.4	Boxed Processor Contents	257



Figures

1-1	Intel® Xeon® Processor E5-2600 Product Family on the 2 Socket Platform	14
1-2	PCI Express* Lane Partitioning and Direct Media Interface Gen 2 (DMI2)	17
2-1	PCI Express* Layering Diagram	26
2-2	Packet Flow through the Layers	27
2-3	Ping()	32
2-4	Ping() Example	32
2-5	GetDIB()	32
2-6	Device Info Field Definition	33
2-7	Revision Number Definition	33
2-8	GetTemp()	34
2-9	GetTemp() Example	35
2-10	RdPkgConfig()	36
2-11	WrPkgConfig()	37
2-12	DRAM Thermal Estimation Configuration Data	40
2-13	DRAM Rank Temperature Write Data	41
2-14	The Processor DIMM Temperature Read / Write	42
2-15	Ambient Temperature Reference Data	42
2-16	Processor DRAM Channel Temperature	43
2-17	Accumulated DRAM Energy Data	43
2-18	DRAM Power Info Read Data	44
2-19	DRAM Power Limit Data	45
2-20	DRAM Power Limit Performance Data	45
2-21	CPUID Data	49
2-22	Platform ID Data	49
2-23	PCU Device ID	49
2-24	Maximum Thread ID	50
2-25	Processor Microcode Revision	50
2-26	Machine Check Status	50
2-27	Package Power SKU Unit Data	50
2-28	Package Power SKU Data	52
2-29	Package Temperature Read Data	52
2-30	Temperature Target Read	53
2-31	Thermal Status Word	54
2-32	Thermal Averaging Constant Write / Read	54
2-33	Current Config Limit Read Data	55
2-34	Accumulated Energy Read Data	55
2-35	Power Limit Data for VCC Power Plane	56
2-36	Package Turbo Power Limit Data	57
2-37	Package Power Limit Performance Data	57
2-38	Efficient Performance Indicator Read	58
2-39	ACPI P-T Notify Data	58
2-40	Caching Agent TOR Read Data	59
2-41	DTS Thermal Margin Read	59
2-42	Processor ID Construction Example	61
2-43	RdIAMS()	61
2-44	PCI Configuration Address	64
2-45	RdPCIC()	64
2-46	PCI Configuration Address for local accesses	66



2-47	RdPCIconfigLocal()	66
2-48	WrPCIconfigLocal()	68
2-49	The Processor PECl Power-up Timeline()	70
2-50	Temperature Sensor Data Format	76
4-1	Idle Power Management Breakdown of the Processor Cores	91
4-2	Thread and Core C-State Entry and Exit	91
4-3	Package C-State Entry and Exit	95
5-1	Tcase: 8-Core 150W Thermal Profile, Workstation Platform SKU Only	105
5-2	DTS: 8-Core 150W Thermal Profile, Workstation Platform SKU Only	105
5-3	Tcase: 8-Core 135W Thermal Profile 2U	107
5-4	DTS: 8-Core 135W Thermal Profile 2U	108
5-5	Tcase: 8/6-Core 130W Thermal Profile 1U	110
5-6	DTS: 8-Core 130W Thermal Profile 1U	110
5-7	DTS: 6-Core 130W Thermal Profile 1U	111
5-8	Tcase: 6-Core 130W 1S WS Thermal Profile	112
5-9	DTS: 6-Core 130W 1S WS Thermal Profile	113
5-10	Tcase: 8-Core 115W Thermal Profile 1U	115
5-11	DTS: 8-Core 115W Thermal Profile 1U	115
5-12	Tcase: 8/6-Core 95W Thermal Profile 1U	117
5-13	DTS: 8-Core 95W Thermal Profile 1U	117
5-14	DTS: 6-Core 95W Thermal Profile 1U	118
5-15	Tcase: 8-Core 70W Thermal Profile 1U	119
5-16	DTS: 8-Core 70W Thermal Profile 1U	120
5-17	Tcase: 6-Core 60W Thermal Profile 1U	121
5-18	DTS: 6-Core 60W Thermal Profile 1U	122
5-19	Tcase: 4-Core 130W Thermal Profile 2U	123
5-20	DTS: 4-Core 130W Thermal Profile 2U	124
5-21	Tcase: 4-Core 130W 1S WS Thermal Profile	126
5-22	DTS: 4-Core 130W 1S WS Thermal Profile	126
5-23	Tcase: 4/2-Core 80W Thermal Profile 1U	128
5-24	DTS: 4-Core 80W Thermal Profile 1U	128
5-25	DTS: 2-Core 80W Thermal Profile 1U	129
5-26	Tcase: 8-Core LV95W Thermal Profile, Embedded Server SKU	131
5-27	Tcase: 8-Core LV70W Thermal Profile, Embedded Server SKU	132
5-28	Case Temperature (TCASE) Measurement Location	134
5-29	Frequency and Voltage Ordering	136
7-1	Input Device Hysteresis	152
7-2	VR Power-State Transitions	156
7-3	8/6-Core: VCC Static and Transient Tolerance Loadlines	170
7-4	4/2-Core: Processor VCC Static and Transient Tolerance Loadlines	172
7-5	Load Current Versus Time	173
7-6	VCC Overshoot Example Waveform	174
7-7	BCLK{0/1} Differential Clock Crosspoint Specification	180
7-8	BCLK{0/1} Differential Clock Measurement Point for Ringback	180
7-9	BCLK{0/1} Single Ended Clock Measurement Points for Absolute Cross Point and Swing	181
7-10	BCLK{0/1} Single Ended Clock Measurement Points for Delta Cross Point	181
7-11	Maximum Acceptable Overshoot/Undershoot Waveform	185
9-1	Processor Package Assembly Sketch	237
9-2	Processor Package Drawing Sheet 1 of 2	239
9-3	Processor Package Drawing Sheet 2 of 2	240
9-4	Processor Top-Side Markings	242



10-1	STS200C Passive/Active Combination Heat Sink (with Removable Fan)	244
10-2	STS200C Passive/Active Combination Heat Sink (with Fan Removed)	244
10-3	STS200P and STS200PNRW 25.5 mm Tall Passive Heat Sinks	245
10-4	Boxed Processor Motherboard Keepout Zones (1 of 4)	246
10-5	Boxed Processor Motherboard Keepout Zones (2 of 4)	247
10-6	Boxed Processor Motherboard Keepout Zones (3 of 4)	248
10-7	Boxed Processor Motherboard Keepout Zones (4 of 4)	249
10-8	Boxed Processor Heat Sink Volumetric (1 of 2)	250
10-9	Boxed Processor Heat Sink Volumetric (2 of 2)	251
10-10	4-Pin Fan Cable Connector (For Active Heat Sink)	252
10-11	4-Pin Base Baseboard Fan Header (For Active Heat Sink)	253
10-12	Fan Cable Connector Pin Out For 4-Pin Active Thermal Solution	255

Tables

1-1	Referenced Documents	22
2-1	Summary of Processor-specific PECI Commands	30
2-2	Minor Revision Number Meaning	33
2-3	GetTemp() Response Definition	35
2-4	RdPkgConfig() Response Definition	36
2-5	WrPkgConfig() Response Definition	37
2-6	RdPkgConfig() & WrPkgConfig() DRAM Thermal and Power Optimization Services Summary	39
2-7	Channel & DIMM Index Decoding	41
2-8	RdPkgConfig() & WrPkgConfig() CPU Thermal and Power Optimization Services Summary	46
2-9	Power Control Register Unit Calculations	51
2-10	RdIAMS() Response Definition	62
2-11	RdIAMS() Services Summary	62
2-12	RdPCICfg() Response Definition	65
2-13	RdPCICfgLocal() Response Definition	67
2-14	WrPCICfgLocal() Response Definition	68
2-15	WrPCICfgLocal() Memory Controller and IIO Device/Function Support	69
2-16	PECI Client Response During Power-Up	69
2-17	SOCKET ID Strapping	71
2-18	Power Impact of PECI Commands vs. C-states	71
2-19	Domain ID Definition	74
2-20	Multi-Domain Command Code Reference	74
2-21	Completion Code Pass/Fail Mask	75
2-22	Device Specific Completion Code (CC) Definition	75
2-23	Originator Response Guidelines	76
2-24	Error Codes and Descriptions	77
4-1	System States	87
4-2	Package C-State Support	87
4-3	Core C-State Support	88
4-4	System Memory Power States	88
4-5	DMI2/PCI Express* Link States	89
4-6	Intel QPI States	89
4-7	G, S and C State Combinations	90
4-8	P_LVLx to MWAIT Conversion	92
4-9	Coordination of Core Power States at the Package Level	95



4-10	Package C-State Power Specifications	97
5-1	Processor SKU Summary Table	104
5-2	Tcase: 8-Core 150W Thermal Specifications, Workstation Platform SKU Only	104
5-3	8-Core 150W Thermal Profile, Workstation Platform SKU Only	106
5-4	Tcase: 8-Core 135W Thermal Specifications 2U	107
5-5	8-Core 135W Thermal Profile Table 2U	108
5-6	Tcase: 8/6-Core 130W Thermal Specifications, Workstation/Server Platform	109
5-7	8/6-Core 130W Thermal Profile Table 1U	111
5-8	Tcase: 6-Core 130W 1S WS Thermal Specifications	112
5-9	6-Core 130W 1S WS Thermal Profile Table	113
5-10	Tcase: 8-Core 115W Thermal Specifications 1U	114
5-11	8-Core 115W Thermal Profile Table 1U	116
5-12	Tcase: 8/6-Core 95W Thermal Specifications, Workstation/Server Platform	116
5-13	8/6-Core 95W Thermal Profile Table 1U	118
5-14	Tcase: 8-Core 70W Thermal Specifications 1U	119
5-15	8-Core 70W Thermal Profile Table 1U	120
5-16	Tcase: 6-Core 60W Thermal Specifications 1U	121
5-17	6-Core 60W Thermal Profile Table 1U	122
5-18	Tcase: 4-Core 130W Thermal Specifications 2U	123
5-19	4-Core 130W Thermal Profile Table 2U	124
5-20	Tcase: 4-Core 130W 1S WS Thermal Specifications, Workstation/Server Platform	125
5-21	4-Core 130W 1S WS Thermal Profile Table	127
5-22	Tcase: 4/2-Core 80W Thermal Specifications 1U	127
5-23	4/2-Core 80W Thermal Profile Table 1U	129
5-24	Embedded Server Processor Elevated Tcase SKU Summary Table	130
5-25	Tcase: 8-Core LV95W Thermal Specifications, Embedded Server SKU	130
5-26	8-Core LV95W Thermal Profile Table, Embedded Server SKU	131
5-27	Tcase: 8-Core LV70W Thermal Specifications, Embedded Server SKU	132
5-28	8-Core LV70W Thermal Profile Table, Embedded Server SKU	133
6-1	Memory Channel DDR0, DDR1, DDR2, DDR3	141
6-2	Memory Channel Miscellaneous	142
6-3	PCI Express* Port 1 Signals	142
6-4	PCI Express* Port 2 Signals	142
6-5	PCI Express* Port 3 Signals	143
6-6	PCI Express* Miscellaneous Signals	143
6-7	DMI2 and PCI Express* Port 0 Signals	144
6-8	Intel QPI Port 0 and 1 Signals	144
6-9	Intel QPI Miscellaneous Signals	144
6-10	PECI Signals	145
6-11	System Reference Clock (BCLK{0/1}) Signals	145
6-12	JTAG and TAP Signals	145
6-13	SVID Signals	146
6-14	Processor Asynchronous Sideband Signals	146
6-15	Miscellaneous Signals	148
6-16	Power and Ground Signals	149
7-1	Power and Ground Lands	154
7-2	SVID Address Usage	157
7-3	VR12.0 Reference Code Voltage Identification (VID) Table	157
7-4	Signal Description Buffer Types	158
7-5	Signal Groups	159
7-6	Signals with On-Die Termination	162
7-7	Power-On Configuration Option Lands	162



7-8	Fault Resilient Booting (Output Tri-State) Signals	163
7-9	Processor Absolute Minimum and Maximum Ratings	164
7-10	Storage Condition Ratings	165
7-11	Voltage Specification	167
7-12	Processor Current Specifications	168
7-13	8/6 Core: Processor VCC Static and Transient Tolerance	169
7-14	4/2-Core: Processor VCC Static and Transient Tolerance	170
7-15	VCC Overshoot Specifications	173
7-16	DDR3 and DDR3L Signal DC Specifications	174
7-17	PECI DC Specifications	176
7-18	System Reference Clock (BCLK{0/1}) DC Specifications	176
7-19	SMBus DC Specifications	176
7-20	JTAG and TAP Signals DC Specifications	177
7-21	Serial VID Interface (SVID) DC Specifications	177
7-22	Processor Asynchronous Sideband DC Specifications	178
7-23	Miscellaneous Signals DC Specifications	179
7-24	Processor I/O Overshoot/Undershoot Specifications	182
7-25	Processor Sideband Signal Group Overshoot/Undershoot Tolerance	184
8-1	Land Name	187
8-2	Land Number	212
9-1	Processor Loading Specifications	241
9-2	Package Handling Guidelines	241
9-3	Processor Materials	242
10-1	PWM Fan Frequency Specifications For 4-Pin Active Thermal Solution	254
10-2	8 Core / 6 Core Server Thermal Solution Boundary Conditions	256
10-3	4 Core Server Thermal Solution Boundary Conditions	256



Revision History

Revision Number	Description	Revision Date
001	Initial Release	March 2012
002	Added Intel® Xeon® Processor E5-4600 Product Family	May 2012

§





1 Overview

1.1 Introduction

The Intel® Xeon® Processor E5-1600/E5-2600/E5-4600 Product Families Datasheet - Volume One provides DC specifications, signal integrity, differential signaling specifications, land and signal definitions, and an overview of additional processor feature interfaces.

The Intel® Xeon® processor E5-1600/E5-2600/E5-4600 product families are the next generation of 64-bit, multi-core enterprise processors built on 32-nanometer process technology. Throughout this document, the Intel® Xeon® processor E5-1600/E5-2600/E5-4600 product families may be referred to as simply the processor. Where information differs between the EP and EP 4S SKUs, this document uses specific Intel® Xeon® processor E5-1600 product family, Intel® Xeon® processor E5-2600 product family, and Intel® Xeon® processor E5-4600 product family notation. Based on the low-power/high performance 2nd Generation Intel® Core™ Processor Family microarchitecture, the processor is designed for a two chip platform consisting of a processor and a Platform Controller Hub (PCH) enabling higher performance, easier validation, and improved x-y footprint. The Intel® Xeon® processor E5-1600 product family and the Intel® Xeon® processor E5-2600 product family are designed for Efficient Performance server, workstation and HPC platforms. The Intel® Xeon® processor E5-4600 product family processor supports scalable server and HPC platforms of two or more processors, including “glueless” 4-way platforms. Note: some processor features are not available on all platforms.

These processors feature per socket, two Intel® QuickPath Interconnect point-to-point links capable of up to 8.0 GT/s, up to 40 lanes of PCI Express* 3.0 links capable of 8.0 GT/s, and 4 lanes of DMI2/PCI Express* 2.0 interface with a peak transfer rate of 5.0 GT/s. The processor supports up to 46 bits of physical address space and 48-bit of virtual address space.

Included in this family of processors is an integrated memory controller (IMC) and integrated I/O (IIO) (such as PCI Express* and DMI2) on a single silicon die. This single die solution is known as a monolithic processor.

Figure 1-1 and Figure 1-2, shows the processor 2-socket and 4-socket platform configuration. The “Legacy CPU” is the boot processor that is connected to the PCH component, this socket is set to NodeID[0]. In the 4-socket configuration, the “Remote CPU” is the processor which is not connected to the Legacy CPU.

Figure 1-1. Intel® Xeon® Processor E5-2600 Product Family on the 2 Socket Platform

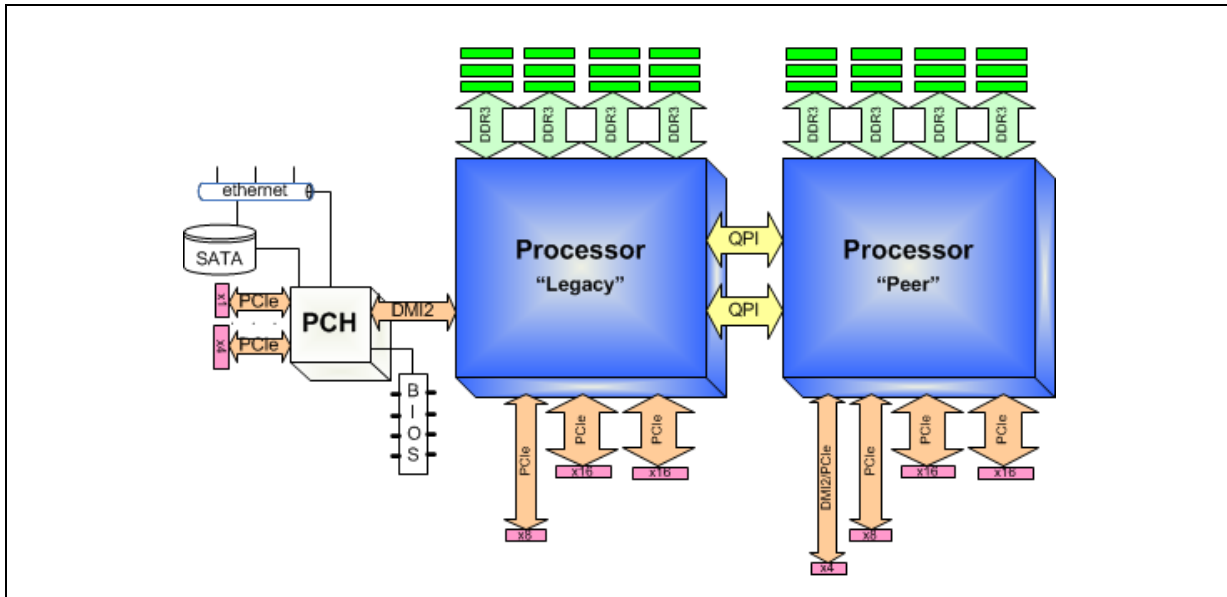
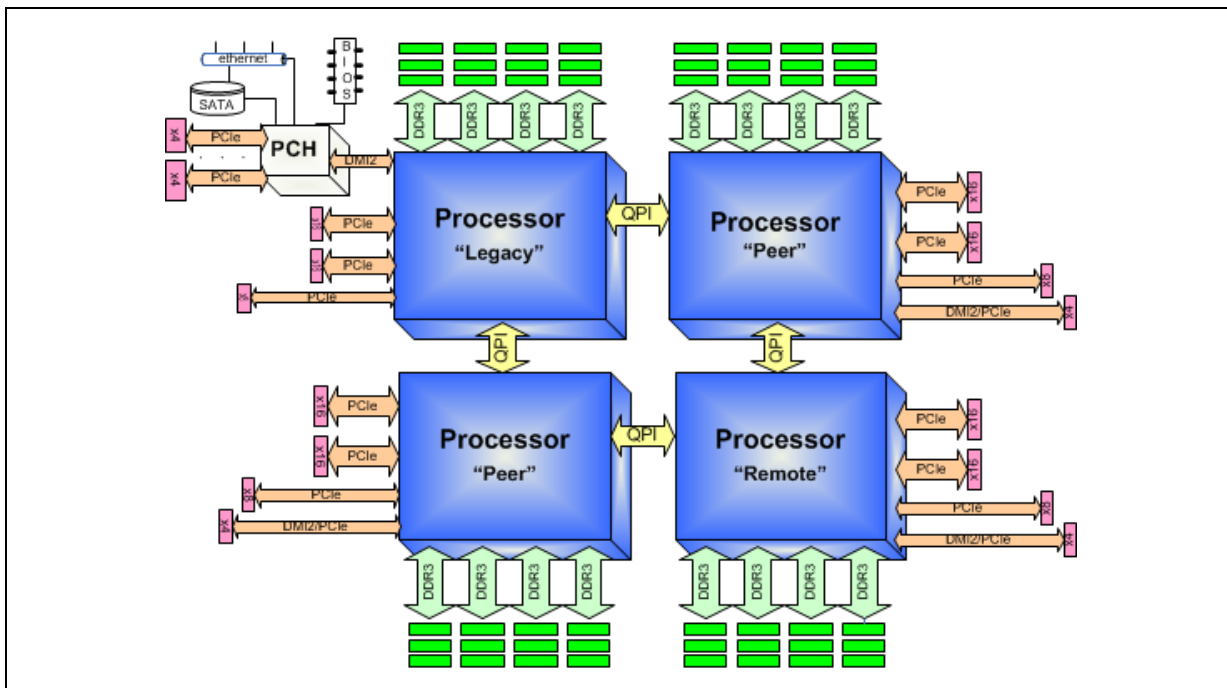


Figure 1-2. Intel® Xeon® Processor E5-4600 Product Family on the 4 Socket Platform



1.1.1 Processor Feature Details

- Up to 8 execution cores
- Each core supports two threads (Intel® Hyper-Threading Technology), up to 16 threads per socket



- 46-bit physical addressing and 48-bit virtual addressing
- 1 GB large page support for server applications
- A 32-KB instruction and 32-KB data first-level cache (L1) for each core
- A 256-KB shared instruction/data mid-level (L2) cache for each core
- Up to 20 MB last level cache (LLC): up to 2.5 MB per core instruction/data last level cache (LLC), shared among all cores
- The Intel® Xeon® processor E5-4600 product family supports Directory Mode, Route Through, and Node IDs to reduce unnecessary Intel QuickPath Interconnect traffic by tracking cache lines present in remote sockets.

1.1.2 Supported Technologies

- Intel® Virtualization Technology (Intel® VT)
- Intel® Virtualization Technology (Intel® VT) for Directed I/O (Intel® VT-d)
- Intel Virtualization Technology Processor Extensions
- Intel® Trusted Execution Technology (Intel® TXT)
- Intel® Advanced Encryption Standard Instructions (Intel® AES-NI)
- Intel 64 Architecture
- Intel® Streaming SIMD Extensions 4.1 (Intel SSE4.1)
- Intel Streaming SIMD Extensions 4.2 (Intel SSE4.2)
- Intel Advanced Vector Extensions (Intel AVX)
- Intel® Hyper-Threading Technology (Intel® HT Technology)
- Execute Disable Bit
- Intel® Turbo Boost Technology
- Intel® Intelligent Power Technology
- Enhanced Intel SpeedStep® Technology
- Intel® Dynamic Power Technology (Intel® DPT) (Memory Power Management)

1.2 Interfaces

1.2.1 System Memory Support

- Intel® Xeon® processor E5-1600/E5-2600/E5-4600 product families supports 4 DDR3 channels
- Unbuffered DDR3 and registered DDR3 DIMMs
- LR DIMM (Load Reduced DIMM) for buffered memory solutions demanding higher capacity memory subsystems
- Independent channel mode or lockstep mode
- Data burst length of eight cycles for all memory organization modes
- Memory DDR3 data transfer rates of 800, 1066, 1333, and 1600 MT/s
- 64-bit wide channels plus 8-bits of ECC support for each channel
- DDR3 standard I/O Voltage of 1.5 V and DDR3 Low Voltage of 1.35 V
- 1-Gb, 2-Gb and 4-Gb DDR3 DRAM technologies supported for these devices:



- UDIMMs x8, x16
- RDIMMs x4, x8
- LRDIMM x4, x8 (2-Gb and 4-Gb only)
- Up to 8 ranks supported per memory channel, 1, 2 or 4 ranks per DIMM
- Open with adaptive idle page close timer or closed page policy
- Per channel memory test and initialization engine can initialize DRAM to all logical zeros with valid ECC (with or without data scrambler) or a predefined test pattern
- Isochronous access support for Quality of Service (QoS), native 1 and 2 socket platforms - Intel® Xeon® processor E5-1600 and E5-2600 product families only
- Minimum memory configuration: independent channel support with 1 DIMM populated
- Integrated dual SMBus master controllers
- Command launch modes of 1n/2n
- RAS Support (including and not limited to):
 - Rank Level Sparing and Device Tagging
 - Demand and Patrol Scrubbing
 - DRAM Single Device Data Correction (SDDC) for any single x4 or x8 DRAM device failure. Independent channel mode supports x4 SDDC. x8 SDDC requires lockstep mode
 - Lockstep mode where channels 0 & 1 and channels 2 & 3 are operated in lockstep mode
 - The combination of memory channel pair lockstep and memory mirroring is not supported
 - Data scrambling with address to ease detection of write errors to an incorrect address.
 - Error reporting via Machine Check Architecture
 - Read Retry during CRC error handling checks by iMC
 - Channel mirroring within a socket Channel Mirroring mode is supported on memory channels 0 & 1 and channels 2 & 3
 - Corrupt Data Containment
 - MCA Recovery
- Improved Thermal Throttling with dynamic Closed Loop Thermal Throttling (CLTT)
- Memory thermal monitoring support for DIMM temperature via two memory signals, MEM_HOT_C{01/23}_N

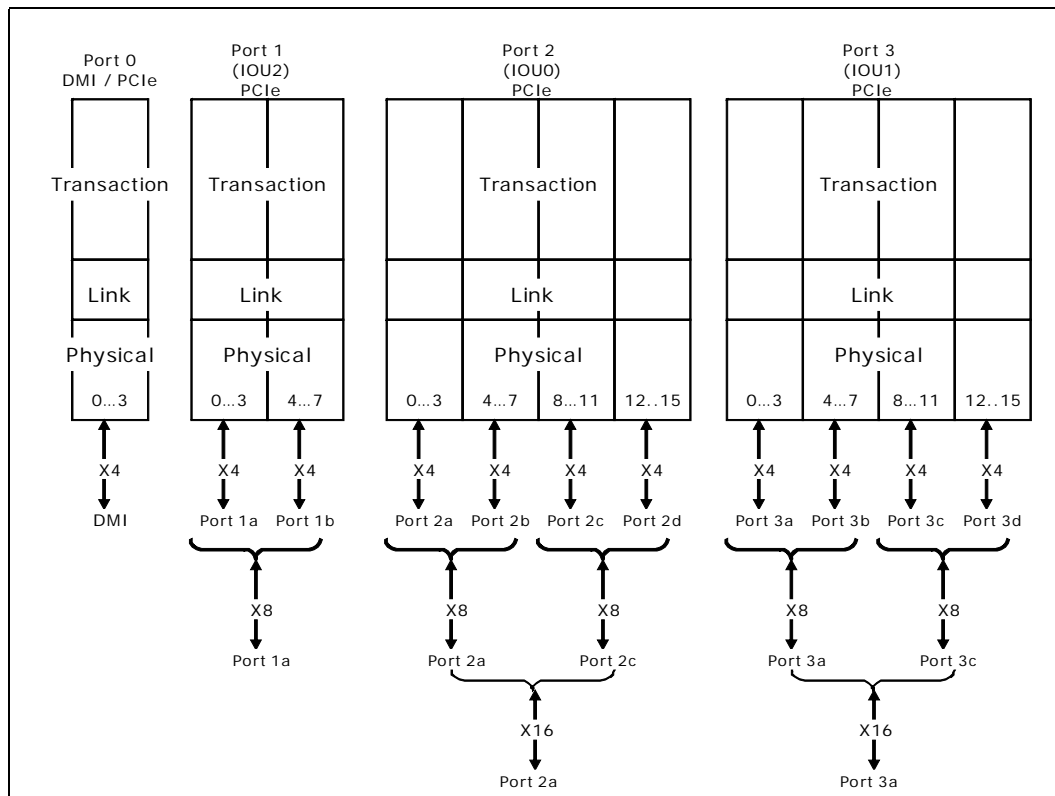
1.2.2 PCI Express*

- The PCI Express* port(s) are fully-compliant to the *PCI Express* Base Specification, Revision 3.0 (PCIe* 3.0)*
- Support for PCI Express* 3.0 (8.0 GT/s), 2.0 (5.0 GT/s), and 1.0 (2.5 GT/s)
- Up to 40 lanes of PCI Express* interconnect for general purpose PCI Express* devices at PCIe* 3.0 speeds that are configurable for up to 10 independent ports
- 4 lanes of PCI Express* at PCIe* 2.0 speeds when not using DMI2 port (Port 0), also can be downgraded to x2 or x1
- Negotiating down to narrower widths is supported, see [Figure 1-3](#):



- x16 port (Port 2 & Port 3) may negotiate down to x8, x4, x2, or x1.
- x8 port (Port 1) may negotiate down to x4, x2, or x1.
- x4 port (Port 0) may negotiate down to x2, or x1.
- When negotiating down to narrower widths, there are caveats as to how lane reversal is supported.
- Non-Transparent Bridge (NTB) is supported by PCIe* Port3a/IOU1. For more details on NTB mode operation refer to *PCI Express Base Specification - Revision 3.0*.
 - x4 or x8 widths and at PCIe* 1.0, 2.0, 3.0 speeds
 - Two usage models; NTB attached to a Root Port or NTB attached to another NTB
 - Supports three 64-bit BARs
 - Supports posted writes and non-posted memory read transactions across the NTB
 - Supports INTx, MSI and MSI-X mechanisms for interrupts on both side of NTB in upstream direction only
- Address Translation Services (ATS) 1.0 support
- Hierarchical PCI-compliant configuration mechanism for downstream devices.
- Traditional PCI style traffic (asynchronous snooped, PCI ordering).
- PCI Express* extended configuration space. The first 256 bytes of configuration space aliases directly to the PCI compatibility configuration space. The remaining portion of the fixed 4-KB block of memory-mapped space above that (starting at 100h) is known as extended configuration space.
- PCI Express* Enhanced Access Mechanism. Accessing the device configuration space in a flat memory mapped fashion.
- Automatic discovery, negotiation, and training of link out of reset.
- Supports receiving and decoding 64 bits of address from PCI Express*.
 - Memory transactions received from PCI Express* that go above the top of physical address space (when Intel VT-d is enabled, the check would be against the translated HPA (Host Physical Address) address) are reported as errors by the processor.
 - Outbound access to PCI Express* will always have address bits 63 to 46 cleared.
- Re-issues Configuration cycles that have been previously completed with the Configuration Retry status.
- Power Management Event (PME) functions.
- Message Signaled Interrupt (MSI and MSI-X) messages
- Degraded Mode support and Lane Reversal support
- Static lane numbering reversal and polarity inversion support

Figure 1-3. PCI Express* Lane Partitioning and Direct Media Interface Gen 2 (DMI2)



1.2.3 Direct Media Interface Gen 2 (DMI 2)

- Serves as the chip-to-chip interface to the Intel® C600 Chipset
- The DMI2 port supports x4 link width and only operates in a x4 mode when in DMI2
- Operates at PCI Express* 1.0 or 2.0 speeds
- Transparent to software
- Processor and peer-to-peer writes and reads with 64-bit address support
- APIC and Message Signaled Interrupt (MSI) support. Will send Intel-defined "End of Interrupt" broadcast message when initiated by the processor.
- System Management Interrupt (SMI), SCI, and SERR error indication
- Static lane numbering reversal support
- Supports DMI2 virtual channels VC0, VC1, VCm, and VCp

1.2.4 Intel® QuickPath Interconnect (Intel® QPI)

- Compliant with Intel QuickPath Interconnect v1.1 standard packet formats
- Implements two full width Intel QPI ports
- Full width port includes 20 data lanes and 1 clock lane
- 64 byte cache-lines
- Isochronous access support for Quality of Service (QoS), native 1 and 2 socket platforms - Intel® Xeon® processor E5-1600 and E5-2600 product families only



- Home snoop based coherency
- 3-bit Node ID
- 46-bit physical addressing support
- No Intel QuickPath Interconnect bifurcation support
- Differential signaling
- Forwarded clocking
- Up to 8.0 GT/s data rate (up to 16 GB/s direction peak bandwidth per port)
 - All ports run at same operational frequency
 - Reference Clock is 100 MHz
 - Slow boot speed initialization at 50 MT/s
- Common reference clocking (same clock generator for both sender and receiver)
- Intel® Interconnect Built-In-Self-Test (Intel® IBIST) for high-speed testability
- Polarity and Lane reversal (Rx side only)

1.2.5 Platform Environment Control Interface (PECI)

The PEFI is a one-wire interface that provides a communication channel between a PEFI client (the processor) and a PEFI master (the PCH).

- Supports operation at up to 2 Mbps data transfers
- Link layer improvements to support additional services and higher efficiency over PEFI 2.0 generation
- Services include CPU thermal and estimated power information, control functions for power limiting, P-state and T-state control, and access for Machine Check Architecture registers and PCI configuration space (both within the processor package and downstream devices)
- PEFI address determined by SOCKET_ID configuration
- Single domain (Domain 0) is supported

1.3 Power Management Support

1.3.1 Processor Package and Core States

- ACPI C-states as implemented by the following processor C-states:
 - Package: PC0, PC1/PC1E, PC2, PC3, PC6 (Package C7 is not supported)
 - Core: CC0, CC1, CC1E, CC3, CC6, CC7
- Enhanced Intel SpeedStep® Technology

1.3.2 System States Support

- S0, S1, S3, S4, S5

1.3.3 Memory Controller

- Multiple CKE power down modes
- Multiple self-refresh modes



- Memory thermal monitoring via MEM_HOT_C01_N and MEM_HOT_C23_N Signals

1.3.4 PCI Express

- L0s is not supported
- L1 ASPM power management capability

1.3.5 Intel QuickPath Interconnect

- L0s is not supported
- L0p and L1 power management capabilities

1.4 Thermal Management Support

- Digital Thermal Sensor with multiple on-die temperature zones
- Adaptive Thermal Monitor
- THERMTRIP_N and PROCHOT_N signal support
- On-Demand mode clock modulation
- Open and Closed Loop Thermal Throttling (OLTT/CLTT) support for system memory in addition to Hybrid OLTT/CLTT mode
- Fan speed control with DTS
- Two integrated SMBus masters for accessing thermal data from DIMMs
- New Memory Thermal Throttling features via MEM_HOT_C{01/23}_N signals
- Running Average Power Limit (RAPL), Processor and DRAM Thermal and Power Optimization Capabilities

1.5 Package Summary

The processor socket is a 52.5 x 45 mm FCLGA package (LGA2011-0 land FCLGA10).

1.6 Terminology

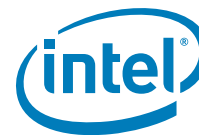
Term	Description
ASPM	Active State Power Management
BMC	Baseboard Management Controllers
Cbo	Cache and Core Box. It is a term used for internal logic providing ring interface to LLC and Core.
DDR3	Third generation Double Data Rate SDRAM memory technology that is the successor to DDR2 SDRAM
DMA	Direct Memory Access
DMI	Direct Media Interface
DMI2	Direct Media Interface Gen 2
DTS	Digital Thermal Sensor
ECC	Error Correction Code



Term	Description
Enhanced Intel SpeedStep® Technology	Allows the operating system to reduce power consumption when performance is not needed.
Execute Disable Bit	The Execute Disable bit allows memory to be marked as executable or non-executable, when combined with a supporting operating system. If code attempts to run in non-executable memory the processor raises an error to the operating system. This feature can prevent some classes of viruses or worms that exploit buffer overrun vulnerabilities and can thus help improve the overall security of the system. See the <i>Intel® 64 and IA-32 Architectures Software Developer's Manuals</i> for more detailed information.
Flit	Flow Control Unit. The Intel QPI Link layer's unit of transfer; 1 Flit = 80-bits.
Functional Operation	Refers to the normal operating conditions in which all processor specifications, including DC, AC, system bus, signal quality, mechanical, and thermal, are satisfied.
IMC	The Integrated Memory Controller. A Memory Controller that is integrated in the processor die.
IIO	The Integrated I/O Controller. An I/O controller that is integrated in the processor die.
Intel® ME	Intel® Management Engine (Intel® ME)
Intel® QuickData Technology	Intel QuickData Technology is a platform solution designed to maximize the throughput of server data traffic across a broader range of configurations and server environments to achieve faster, scalable, and more reliable I/O.
Intel® QuickPath Interconnect (Intel® QPI)	A cache-coherent, link-based Interconnect specification for Intel processors, chipsets, and I/O bridge components.
Intel® 64 Technology	64-bit memory extensions to the IA-32 architecture. Further details on Intel 64 architecture and programming model can be found at http://developer.intel.com/technology/intel64/ .
Intel® Turbo Boost Technology	Intel® Turbo Boost Technology is a way to automatically run the processor core faster than the marked frequency if the part is operating under power, temperature, and current specifications limits of the Thermal Design Power (TDP). This results in increased performance of both single and multi-threaded applications.
Intel® TXT	Intel® Trusted Execution Technology
Intel® Virtualization Technology (Intel® VT)	Processor virtualization which when used in conjunction with Virtual Machine Monitor software enables multiple, robust independent software environments inside a single platform.
Intel® VT-d	Intel® Virtualization Technology (Intel® VT) for Directed I/O. Intel VT-d is a hardware assist, under system software (Virtual Machine Manager or OS) control, for enabling I/O device virtualization. Intel VT-d also brings robust security by providing protection from errant DMAs by using DMA remapping, a key feature of Intel VT-d.
Intel® Xeon® processor E5-1600 product family and Intel® Xeon® processor E5-2600 product family	Intel's 32-nm processor design, follow-on to the 32-nm 2nd Generation Intel® Core™ Processor Family design. It is the first processor for use in Intel® Xeon® processor E5-1600 and E5-2600 product families-based platforms. Intel® Xeon® processor E5-1600 product family and Intel® Xeon® processor E5-2600 product family supports Efficient Performance server, workstation and HPC platforms
Intel® Xeon® processor E5-4600 product family	Intel's 32-nm processor design, follow-on to the 32-nm processor design. It is the first processor for use in Intel® Xeon® processor E5-4600 product family-based platforms. Intel® Xeon® processor E5-4600 product family supports scalable server and HPC platforms for two or more processors, including glueless four-way platforms.
Integrated Heat Spreader (IHS)	A component of the processor package used to enhance the thermal performance of the package. Component thermal solutions interface with the processor at the IHS surface.
Jitter	Any timing variation of a transition edge or edges from the defined Unit Interval (UI).
IOV	I/O Virtualization
LGA2011-0 land FCLGA10 Socket	The processor mates with the system board through this surface mount, LGA2011-0 land FCLGA10 contact socket, for the Intel® Xeon® processor E5 product family-based platform.



Term	Description
LLC	Last Level Cache
LRDIMM	Load Reduced Dual In-line Memory Module
NCTF	Non-Critical to Function: NCTF locations are typically redundant ground or non-critical reserved, so the loss of the solder joint continuity at end of life conditions will not affect the overall product functionality.
NEBS	Network Equipment Building System. NEBS is the most common set of environmental design guidelines applied to telecommunications equipment in the United States.
PCH	Platform Controller Hub (Intel® C600 Chipset). The next generation chipset with centralized platform capabilities including the main I/O interfaces along with display connectivity, audio features, power management, manageability, security and storage features.
PCU	Power Control Unit
PCI Express* 3.0	The third generation PCI Express* specification that operates at twice the speed of PCI Express* 2.0 (8 Gb/s); however, PCI Express* 3.0 is completely backward compatible with PCI Express* 1.0 and 2.0.
PCI Express* 3	PCI Express* Generation 3.0
PCI Express* 2	PCI Express* Generation 2.0
PCI Express*	PCI Express* Generation 2.0/3.0
PECI	Platform Environment Control Interface
Phit	Physical Unit. An Intel® QPI terminology defining units of transfer at the physical layer. 1 Phit is equal to 20 bits in 'full width mode' and 10 bits in 'half width mode'
Processor	The 64-bit, single-core or multi-core component (package)
Processor Core	The term "processor core" refers to silicon die itself which can contain multiple execution cores. Each execution core has an instruction cache, data cache, and 256-KB L2 cache. All execution cores share the L3 cache. All DC and signal integrity specifications are measured at the processor die (pads), unless otherwise noted.
RDIMM	Registered Dual In-line Memory Module
Rank	A unit of DRAM corresponding four to eight devices in parallel, ignoring ECC. These devices are usually, but not always, mounted on a single side of a DDR3 DIMM.
Scalable-2S	Intel® Xeon® processor E5 product family-based platform targeted for scalable designs using third party Node Controller chip. In these designs, Node Controller is used to scale the design beyond one/two/four sockets.
SCI	System Control Interrupt. Used in ACPI protocol.
SSE	Intel® Streaming SIMD Extensions (Intel® SSE)
SKU	A processor Stock Keeping Unit (SKU) to be installed in either server or workstation platforms. Electrical, power and thermal specifications for these SKU's are based on specific use condition assumptions. Server processors may be further categorized as Efficient Performance server, workstation and HPC SKUs. For further details on use condition assumptions, please refer to the latest Product Release Qualification (PRQ) Report available via your Customer Quality Engineer (CQE) contact.
SMBus	System Management Bus. A two-wire interface through which simple system and power management related devices can communicate with the rest of the system. It is based on the principals of the operation of the I2C* two-wire serial bus from Philips Semiconductor.
Storage Conditions	A non-operational state. The processor may be installed in a platform, in a tray, or loose. Processors may be sealed in packaging or exposed to free air. Under these conditions, processor landings should not be connected to any supply voltages, have any I/Os biased or receive any clocks. Upon exposure to "free air" (i.e., unsealed packaging or a device removed from packaging material) the processor must be handled in accordance with moisture sensitivity labeling (MSL) as indicated on the packaging material.
TAC	Thermal Averaging Constant



Term	Description
TDP	Thermal Design Power
TSOD	Thermal Sensor on DIMM
UDIMM	Unbuffered Dual In-line Module
Uncore	The portion of the processor comprising the shared cache, IMC, HA, PCU, UBox, and Intel QPI link interface.
Unit Interval	Signaling convention that is binary and unidirectional. In this binary signaling, one bit is sent for every edge of the forwarded clock, whether it be a rising edge or a falling edge. If a number of edges are collected at instances $t_1, t_2, t_n, \dots, t_k$ then the UI at instance "n" is defined as: $UI_n = t_n - t_{n-1}$
V_{CC}	Processor core power supply
V_{SS}	Processor ground
V_{CCD_01}, V_{CCD_23}	Variable power supply for the processor system memory interface. VCCD is the generic term for V_{CCD_01}, V_{CCD_23} .
x1	Refers to a Link or Port with one Physical Lane
x4	Refers to a Link or Port with four Physical Lanes
x8	Refers to a Link or Port with eight Physical Lanes
x16	Refers to a Link or Port with sixteen Physical Lanes

1.7 Related Documents

Refer to the following documents for additional information.

Table 1-1. Referenced Documents (Sheet 1 of 2)

Document	Location
<i>Intel® Xeon® Processor E5 Product Family Datasheet Volume Two</i>	http://www.intel.com
<i>Intel® Xeon® Processor E5-1600/E5-2600/E5-4600 Product Families Thermal/Mechanical Design Guide</i>	http://www.intel.com
<i>Intel® Xeon® Processor E5-1600/E5-2600/E5-4600 Product Families – BSDL (Boundary Scan Description Language)</i>	http://www.intel.com
<i>Intel® C600 Series Chipset Data Sheet</i>	http://www.intel.com
<i>Intel® 64 and IA-32 Architectures Software Developer's Manual (SDM) Volumes 1, 2, and 3</i>	http://www.intel.com
<i>Advanced Configuration and Power Interface Specification 3.0</i>	http://www.acpi.info
<i>PCI Local Bus Specification 3.0</i>	http://www.pcisig.com/specifications
<i>PCI Express Base Specification - Revision 2.1 and 1.1</i> <i>PCI Express Base Specification - Revision 3.0</i>	http://www.pcisig.com
<i>System Management Bus (SMBus) Specification</i>	http://smbus.org/
<i>DDR3 SDRAM Specification</i>	http://www.jedec.org
<i>Low (JESD22-A119) and High (JESD-A103) Temperature Storage Life Specifications</i>	http://www.jedec.org
<i>Intel 64 and IA-32 Architectures Software Developer's Manuals</i> <ul style="list-style-type: none"> • Volume 1: Basic Architecture • Volume 2A: Instruction Set Reference, A-M • Volume 2B: Instruction Set Reference, N-Z • Volume 3A: System Programming Guide • Volume 3B: System Programming Guide <i>Intel® 64 and IA-32 Architectures Optimization Reference Manual</i>	http://www.intel.com/products/processor/manuals/index.htm



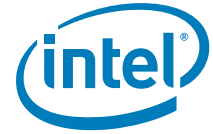
Table 1-1. Referenced Documents (Sheet 2 of 2)

Document	Location
<i>Intel® Virtualization Technology Specification for Directed I/O Architecture Specification</i>	http://download.intel.com/technology/computing/vptech/Intel(r)_VT_for_Direct_IO.pdf
<i>Intel® Trusted Execution Technology Software Development Guide</i>	http://www.intel.com/technology/security/

1.8 State of Data

The data contained within this document is the most accurate information available by the publication date of this document.

§



2 Interfaces

This chapter describes the interfaces supported by the processor.

2.1 System Memory Interface

2.1.1 System Memory Technology Support

The Integrated Memory Controller (IMC) supports DDR3 protocols with four independent 64-bit memory channels with 8 bits of ECC for each channel (total of 72-bits) and supports 1 to 3 DIMMs per channel depending on the type of memory installed. The type of memory supported by the processor is dependent on the target platform:

- Intel® Xeon® processor E5 product family-based platforms support:
 - ECC registered DIMMs: with a maximum of three DIMMs per channel allowing up to eight device ranks per channel.
 - ECC and non-ECC unbuffered DIMMs: with a maximum of two DIMMs per channel thus allowing up to four device ranks per channel. Support for mixed non-ECC with ECC un-buffered DIMM configurations.

2.1.2 System Memory Timing Support

The IMC supports the following DDR3 Speed Bin, CAS Write Latency (CWL), and command signal mode timings on the main memory interface:

- tCL = CAS Latency
- tRCD = Activate Command to READ or WRITE Command delay
- tRP = PRECHARGE Command Period
- CWL = CAS Write Latency
- Command Signal modes = 1n indicates a new command may be issued every clock and 2n indicates a new command may be issued every 2 clocks. Command launch mode programming depends on the transfer rate and memory configuration.

2.2 PCI Express* Interface

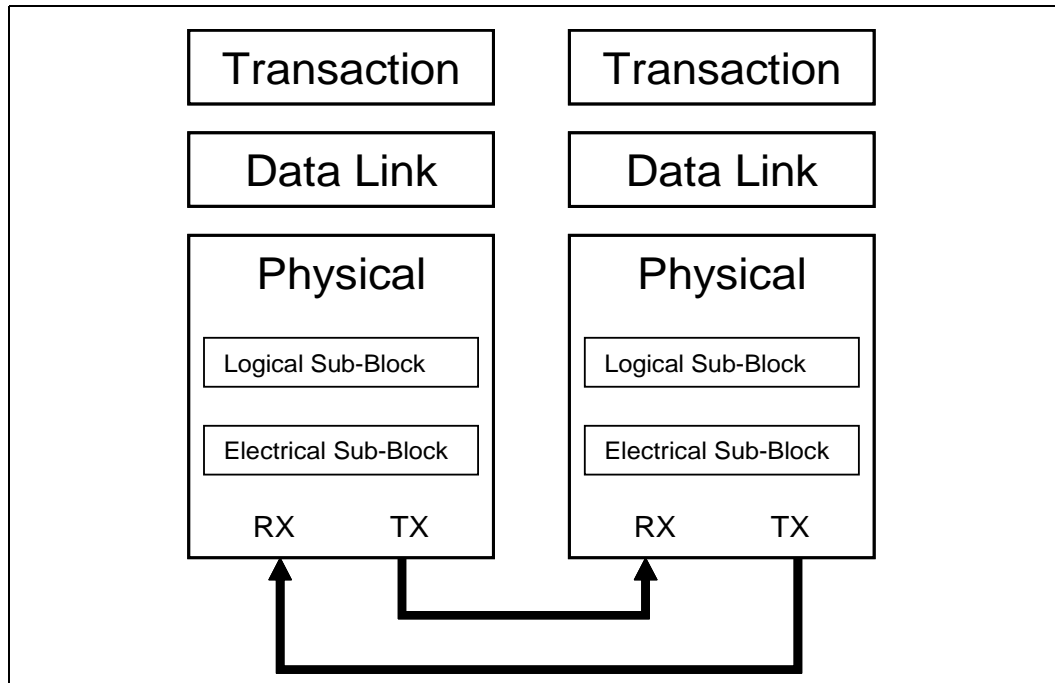
This section describes the PCI Express* 3.0 interface capabilities of the processor. See the *PCI Express* Base Specification* for details of PCI Express* 3.0.

2.2.1 PCI Express* Architecture

Compatibility with the PCI addressing model is maintained to ensure that all existing applications and drivers operate unchanged. The PCI Express* configuration uses standard mechanisms as defined in the PCI Plug-and-Play specification.

The PCI Express* architecture is specified in three layers: Transaction Layer, Data Link Layer, and Physical Layer. The partitioning in the component is not necessarily along these same boundaries. Refer to [Figure 2-1](#) for the PCI Express* Layering Diagram.

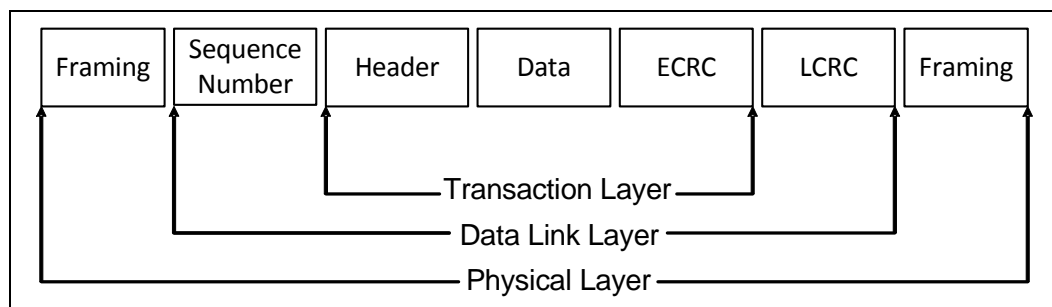
Figure 2-1. PCI Express* Layering Diagram



PCI Express* uses packets to communicate information between components. Packets are formed in the Transaction and Data Link Layers to carry the information from the transmitting component to the receiving component. As the transmitted packets flow through the other layers, they are extended with additional information necessary to handle packets at those layers. At the receiving side, the reverse process occurs and packets get transformed from their Physical Layer representation to the Data Link Layer representation and finally (for Transaction Layer Packets) to the form that can be processed by the Transaction Layer of the receiving device.



Figure 2-2. Packet Flow through the Layers



2.2.1.1 Transaction Layer

The upper layer of the PCI Express* architecture is the Transaction Layer. The Transaction Layer's primary responsibility is the assembly and disassembly of Transaction Layer Packets (TLPs). TLPs are used to communicate transactions, such as read and write, as well as certain types of events. The Transaction Layer also manages flow control of TLPs.

2.2.1.2 Data Link Layer

The middle layer in the PCI Express* stack, the Data Link Layer, serves as an intermediate stage between the Transaction Layer and the Physical Layer. Responsibilities of Data Link Layer include link management, error detection, and error correction.

The transmission side of the Data Link Layer accepts TLPs assembled by the Transaction Layer, calculates and applies data protection code and TLP sequence number, and submits them to Physical Layer for transmission across the Link. The receiving Data Link Layer is responsible for checking the integrity of received TLPs and for submitting them to the Transaction Layer for further processing. On detection of TLP error(s), this layer is responsible for requesting retransmission of TLPs until information is correctly received, or the Link is determined to have failed. The Data Link Layer also generates and consumes packets which are used for Link management functions.

2.2.1.3 Physical Layer

The Physical Layer includes all circuitry for interface operation, including driver and input buffers, parallel-to-serial and serial-to-parallel conversion, PLL(s), and impedance matching circuitry. It also includes logical functions related to interface initialization and maintenance. The Physical Layer exchanges data with the Data Link Layer in an implementation-specific format, and is responsible for converting this to an appropriate serialized format and transmitting it across the PCI Express* Link at a frequency and width compatible with the remote device.

2.2.2 PCI Express* Configuration Mechanism

The PCI Express* link is mapped through a PCI-to-PCI bridge structure.

PCI Express* extends the configuration space to 4096 bytes per-device/function, as compared to 256 bytes allowed by the *Conventional PCI Specification*. PCI Express* configuration space is divided into a PCI-compatible region (which consists of the first



256 bytes of a logical device's configuration space) and an extended PCI Express* region (which consists of the remaining configuration space). The PCI-compatible region can be accessed using either the mechanisms defined in the PCI specification or using the enhanced PCI Express* configuration access mechanism described in the PCI Express* Enhanced Configuration Mechanism section.

The PCI Express* Host Bridge is required to translate the memory-mapped PCI Express* configuration space accesses from the host processor to PCI Express* configuration cycles. To maintain compatibility with PCI configuration addressing mechanisms, it is recommended that system software access the enhanced configuration space using 32-bit operations (32-bit aligned) only.

See the *PCI Express* Base Specification* for details of both the PCI-compatible and PCI Express* Enhanced configuration mechanisms and transaction rules.

2.3 DMI 2/PCI Express* Interface

Direct Media Interface 2 (DMI2) connects the processor to the Platform Controller Hub (PCH). DMI2 is similar to a four-lane PCI Express* supporting a speed of 5 GT/s per lane. This interface can be configured at power-on to serve as a x4 PCI Express* link based on the setting of the SOCKET_ID[1:0] and FRMAGENT signal for processors not connected to a PCH.

Note: Only DMI2 x4 configuration is supported.

2.3.1 DMI 2 Error Flow

DMI2 can only generate SERR in response to errors, never SCI, SMI, MSI, PCI INT, or GPE. Any DMI2 related SERR activity is associated with Device 0.

2.3.2 Processor/PCH Compatibility Assumptions

The processor is compatible with the PCH and is not compatible with any previous MCH or ICH products.

2.3.3 DMI 2 Link Down

The DMI2 link going down is a fatal, unrecoverable error. If the DMI2 data link goes to data link down, after the link was up, then the DMI2 link hangs the system by not allowing the link to retrain to prevent data corruption. This is controlled by the PCH.

Downstream transactions that had been successfully transmitted across the link prior to the link going down may be processed as normal. No completions from downstream, non-posted transactions are returned upstream over the DMI2 link after a link down event.

2.4 Intel QuickPath Interconnect

The Intel QuickPath Interconnect is a high speed, packetized, point-to-point interconnect used in the 2nd Generation Intel(r) Core(TM) Processor Family. The narrow high-speed links stitch together processors in distributed shared memory and integrated I/O platform architecture. It offers much higher bandwidth with low latency. The Intel QuickPath Interconnect has an efficient architecture allowing more interconnect performance to be achieved in real systems. It has a snoop protocol



optimized for low latency and high scalability, as well as packet and lane structures enabling quick completions of transactions. Reliability, availability, and serviceability features (RAS) are built into the architecture.

The physical connectivity of each interconnect link is made up of twenty differential signal pairs plus a differential forwarded clock. Each port supports a link pair consisting of two uni-directional links to complete the connection between two components. This supports traffic in both directions simultaneously. To facilitate flexibility and longevity, the interconnect is defined as having five layers: Physical, Link, Routing, Transport, and Protocol.

- **The Physical layer** consists of the actual wires carrying the signals, as well as circuitry and logic to support ancillary features required in the transmission and receipt of the 1s and 0s. The unit of transfer at the Physical layer is 20-bits, which is called a Phit (for Physical unit).
- **The Link layer** is responsible for reliable transmission and flow control. The Link layer's unit of transfer is 80-bits, which is called a Flit (for Flow control unit).
- **The Routing layer** provides the framework for directing packets through the fabric.
- **The Transport layer** is an architecturally defined layer (not implemented in the initial products) providing advanced routing capability for reliable end-to-end transmission.
- **The Protocol layer** is the high-level set of rules for exchanging packets of data between devices. A packet is comprised of an integral number of Flits.

The Intel QuickPath Interconnect includes a cache coherency protocol to keep the distributed memory and caching structures coherent during system operation. It supports both low-latency source snooping and a scalable home snoop behavior. The coherency protocol provides for direct cache-to-cache transfers for optimal latency.



2.5 Platform Environment Control Interface (PECI)

The Platform Environment Control Interface (PECI) uses a single wire for self-clocking and data transfer. The bus requires no additional control lines. The physical layer is a self-clocked one-wire bus that begins each bit with a driven, rising edge from an idle level near zero volts. The duration of the signal driven high depends on whether the bit value is a logic '0' or logic '1'. PECI also includes variable data transfer rate established with every message. In this way, it is highly flexible even though underlying logic is simple.

The interface design was optimized for interfacing to Intel processor and chipset components in both single processor and multiple processor environments. The single wire interface provides low board routing overhead for the multiple load connections in the congested routing area near the processor and chipset components. Bus speed, error checking, and low protocol overhead provides adequate link bandwidth and reliability to transfer critical device operating conditions and configuration information.

The PECI bus offers:

- A wide speed range from 2 Kbps to 2 Mbps
- CRC check byte used to efficiently and atomically confirm accurate data delivery
- Synchronization at the beginning of every message minimizes device timing accuracy requirements

Note: The PECI commands described in this document apply primarily to the Intel® Xeon® processor E5-1600/E5-2600/E5-4600 product families. The processors utilizes the capabilities described in this document to indicate support for four memory channels. Refer to [Table 2-1](#) for the list of PECI commands supported by the processors.

Table 2-1. Summary of Processor-specific PECI Commands

Command	Supported on the Processor
Ping()	Yes
GetDIB()	Yes
GetTemp()	Yes
RdPkgConfig()	Yes
WrPkgConfig()	Yes
RdIAMS()	Yes
WrIAMS()	No
RdPCIConfig()	Yes
WrPCIConfig()	No
RdPCIConfigLocal()	Yes
WrPCIConfigLocal()	Yes

2.5.1 PECI Client Capabilities

The processor PECI client is designed to support the following sideband functions:

- Processor and DRAM thermal management
- Platform manageability functions including thermal, power, and error monitoring
 - The platform 'power' management includes monitoring and control for both the processor and DRAM subsystem to assist with data center power limiting.
- Processor interface tuning and diagnostics capabilities (Intel® Interconnect BIST).



2.5.1.1 Thermal Management

Processor fan speed control is managed by comparing Digital Thermal Sensor (DTS) thermal readings acquired via PECCI against the processor-specific fan speed control reference point, or T_{CONTROL} . Both T_{CONTROL} and DTS thermal readings are accessible via the processor PECCI client. These variables are referenced to a common temperature, the TCC activation point, and are both defined as negative offsets from that reference.

PECCI-based access to the processor package configuration space provides a means for Baseboard Management Controllers (BMCs) or other platform management devices to actively manage the processor and memory power and thermal features. Details on the list of available power and thermal optimization services can be found in [Section 2.5.2.6](#).

2.5.1.2 Platform Manageability

PECCI allows read access to certain error registers in the processor MSR space and status monitoring registers in the PCI configuration space within the processor and downstream devices. Details are covered in subsequent sections.

PECCI permits writes to certain Memory Controller RAS-related registers in the processor PCI configuration space. Details are covered in [Section 2.5.2.10](#).

2.5.1.3 Processor Interface Tuning and Diagnostics

The processor Intel® Interconnect Built In Self Test (Intel® IBIST) allows for in-field diagnostic capabilities in the Intel® QPI and memory controller interfaces. PECCI provides a port to execute these diagnostics via its PCI Configuration read and write capabilities in the BMC INIT mode. Refer to [Section 2.5.3.7](#) for more details.

2.5.2 Client Command Suite

PECCI command requires at least one frame check sequence (FCS) byte to ensure reliable data exchange between originator and client. The PECCI message protocol defines two FCS bytes that are returned by the client to the message originator. The first FCS byte covers the client address byte, the Read and Write Length bytes, and all bytes in the write data block. The second FCS byte covers the read response data returned by the PECCI client. The FCS byte is the result of a cyclic redundancy check (CRC) of each data block.

2.5.2.1 Ping()

Ping() is a required message for all PECCI devices. This message is used to enumerate devices or determine if a device has been removed, been powered-off, etc. A Ping() sent to a device address always returns a non-zero Write FCS if the device at the targeted address is able to respond.

2.5.2.1.1 Command Format

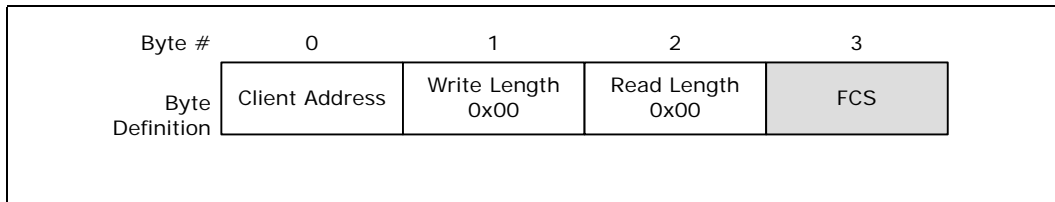
The Ping() format is as follows:

Write Length: 0x00

Read Length: 0x00

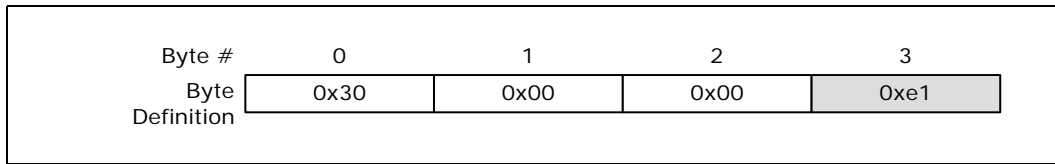


Figure 2-3. Ping()



An example Ping() command to PECI device address 0x30 is shown below.

Figure 2-4. Ping() Example



2.5.2.2 GetDIB()

The processor PECI client implementation of GetDIB() includes an 8-byte response and provides information regarding client revision number and the number of supported domains. All processor PECI clients support the GetDIB() command.

2.5.2.2.1 Command Format

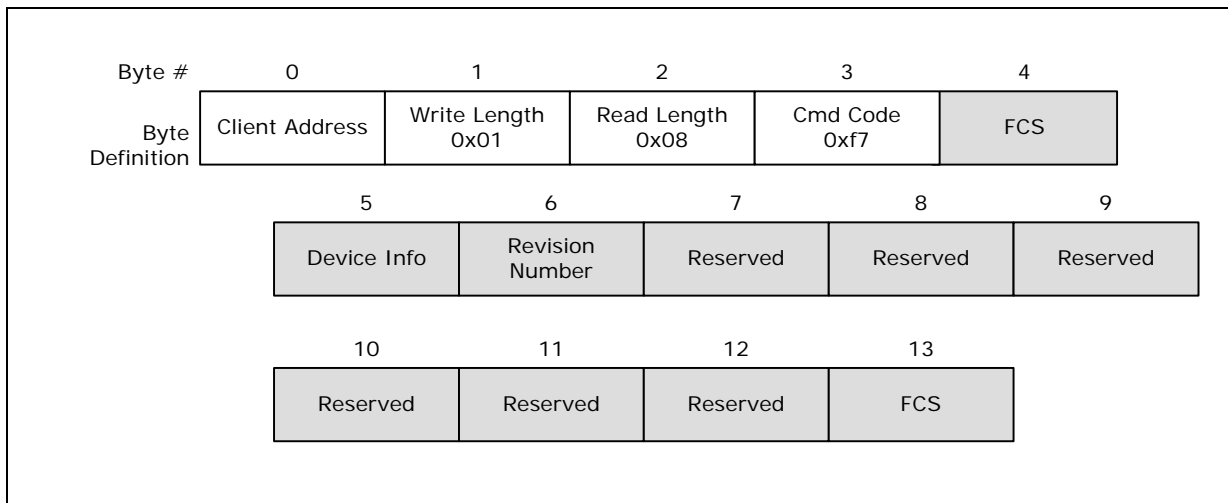
The GetDIB() format is as follows:

Write Length: 0x01

Read Length: 0x08

Command: 0xf7

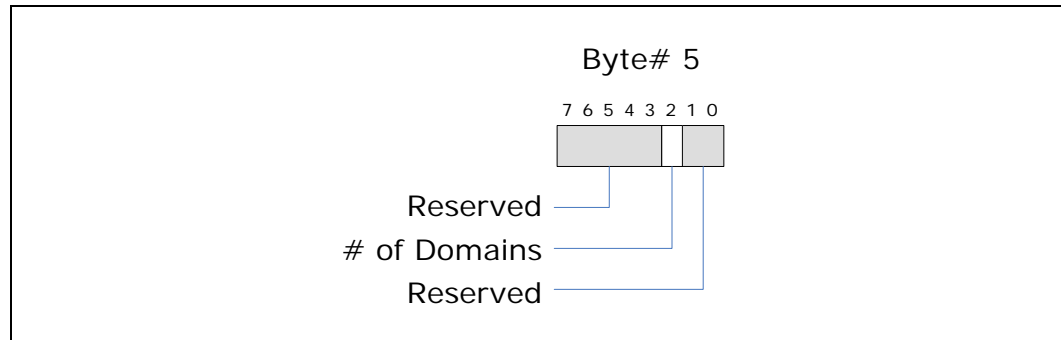
Figure 2-5. GetDIB()



2.5.2.2.2 Device Info

The Device Info byte gives details regarding the PECI client configuration. At a minimum, all clients supporting GetDIB will return the number of domains inside the package via this field. With any client, at least one domain (Domain 0) must exist. Therefore, the Number of Domains reported is defined as the number of domains in addition to Domain 0. For example, if bit 2 of the Device Info byte returns a '1', that would indicate that the PECI client supports two domains.

Figure 2-6. Device Info Field Definition



2.5.2.2.3 Revision Number

All clients that support the GetDIB command also support Revision Number reporting. The revision number may be used by a host or originator to manage different command suites or response codes from the client. Revision Number is always reported in the second byte of the GetDIB() response. The 'Major Revision' number in [Figure 2-7](#) always maps to the revision number of the PECI specification that the PECI client processor is designed to. The 'Minor Revision' number value depends on the exact command suite supported by the PECI client as defined in [Table 2-2](#).

Figure 2-7. Revision Number Definition

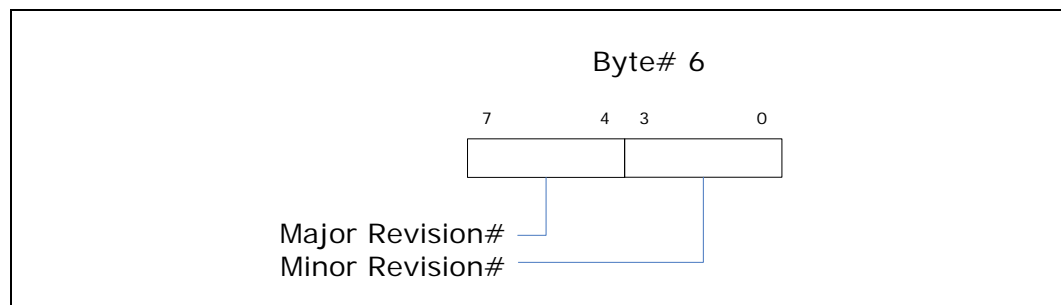


Table 2-2. Minor Revision Number Meaning

Minor Revision	Supported Command Suite
0	Ping(), GetDIB(), GetTemp()
1	Ping(), GetDIB(), GetTemp(), WrPkgConfig(), RdPkgConfig()
2	Ping(), GetDIB(), GetTemp(), WrPkgConfig(), RdPkgConfig(), RdIAMSRR()
3	Ping(), GetDIB(), GetTemp(), WrPkgConfig(), RdPkgConfig(), RdIAMSRR(), RdPCIConfigLocal(), WrPCIConfigLocal()
4	Ping(), GetDIB(), GetTemp(), WrPkgConfig(), RdPkgConfig(), RdIAMSRR(), RdPCIConfigLocal(), WrPCIConfigLocal(), RdPCIConfig()



Table 2-2. Minor Revision Number Meaning

Minor Revision	Supported Command Suite
5	Ping(), GetDIB(), GetTemp(), WrPkgConfig(), RdPkgConfig(), RdIAMSRO(), RdPCIconfigLocal(), WrPCIconfigLocal(), RdPCIconfig(), WrPCIconfig()
6	Ping(), GetDIB(), GetTemp(), WrPkgConfig(), RdPkgConfig(), RdIAMSRO(), RdPCIconfigLocal(), WrPCIconfigLocal(), RdPCIconfig(), WrPCIconfig(), WrIAMSRO()

For the processor PECE client the Revision Number will return '0011 0100b'.

2.5.2.3 GetTemp()

The GetTemp() command is used to retrieve the maximum die temperature from a target PECE address. The temperature is used by the external thermal management system to regulate the temperature on the die. The data is returned as a negative value representing the number of degrees centigrade below the maximum processor junction temperature (T_{jmax}). The maximum PECE temperature value of zero corresponds to the processor T_{jmax} . This also represents the default temperature at which the processor Thermal Control Circuit activates. The actual value that the thermal management system uses as a control set point ($T_{CONTROL}$) is also defined as a negative number below T_{jmax} . $T_{CONTROL}$ may be extracted from the processor by issuing a PECE RdPkgConfig() command as described in Section 2.5.2.4 or using a RDMSR instruction. $T_{CONTROL}$ application to fan speed control management is defined in the *Intel® Xeon® Processor E5-1600/E5-2600/E5-4600 Product Families Thermal/Mechanical Design Guide*.

Please refer to Section 2.5.7 for details regarding PECE temperature data formatting.

2.5.2.3.1 Command Format

The GetTemp() format is as follows:

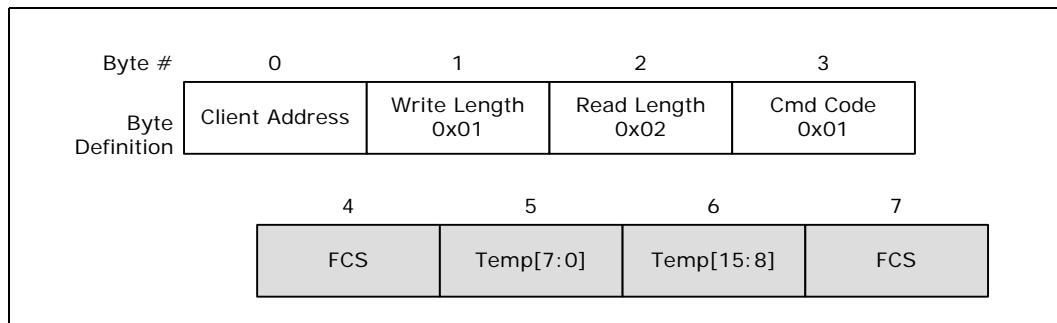
Write Length: 0x01

Read Length: 0x02

Command: 0x01

Description: Returns the highest die temperature for addressed processor PECE client.

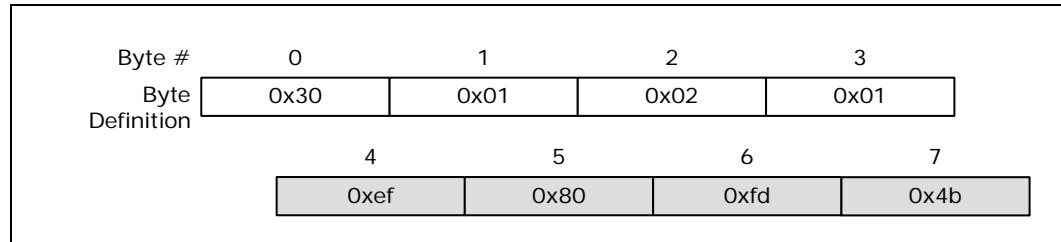
Figure 2-8. GetTemp()





Example bus transaction for a thermal sensor device located at address 0x30 returning a value of negative 10 counts is show in [Figure 2-9](#).

Figure 2-9. GetTemp() Example



2.5.2.3.2 Supported Responses

The typical client response is a passing FCS and valid thermal data. Under some conditions, the client's response will indicate a failure. GetTemp() response definitions are listed in [Table 2-3](#). Refer to [Section 2.5.7.4](#) for more details on sensor errors.

Table 2-3. GetTemp() Response Definition

Response	Meaning
General Sensor Error (GSE) ¹	Thermal scan did not complete in time. Retry is appropriate.
Bad Write FCS	Electrical error
Abort FCS	Illegal command formatting (mismatched RL/WL/Command Code)
0x0000 ¹	Processor is running at its maximum temperature or is currently being reset.
All other data	Valid temperature reading, reported as a negative offset from the processor T_{jmax} .

Notes:

1. This response will be reflected in Bytes 5 & 6 in [Figure 2-9](#).

2.5.2.4 RdPkgConfig()

The RdPkgConfig() command provides read access to the package configuration space (PCS) within the processor, including various power and thermal management functions. Typical PCS read services supported by the processor may include access to temperature data, energy status, run time information, DIMM temperatures and so on. Refer to [Section 2.5.2.6](#) for more details on processor-specific services supported through this command.

2.5.2.4.1 Command Format

The RdPkgConfig() format is as follows:

Write Length: 0x05

Read Length: 0x05 (dword)

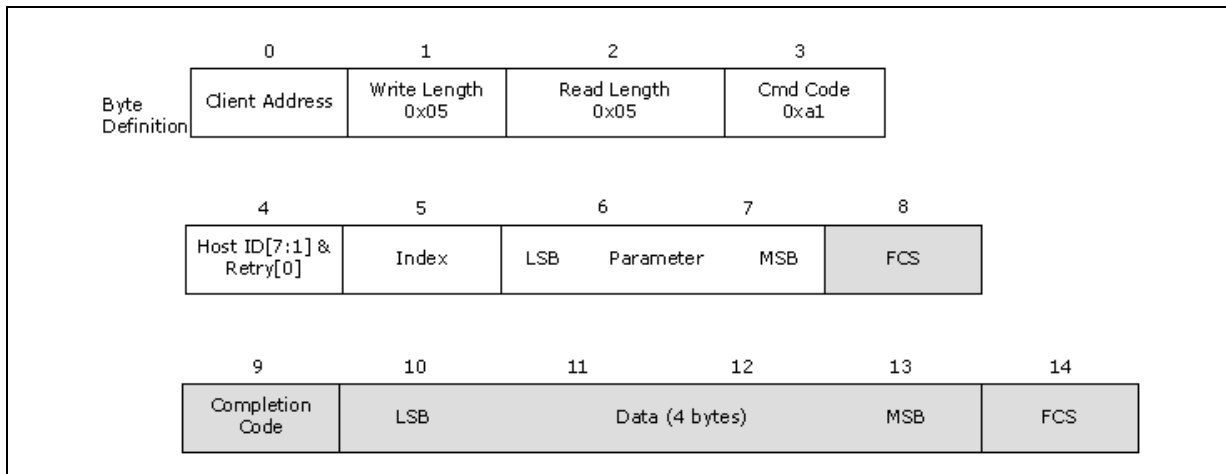
Command: 0xa1

Description: Returns the data maintained in the processor package configuration space for the PCS entry as specified by the 'index' and 'parameter' fields. The 'index' field contains the encoding for the requested service and is used in conjunction with the 'parameter' field to specify the exact data being requested. The Read Length dictates the desired data return size. This command supports only dword responses on the



processor PECL clients. All command responses are prepended with a completion code that contains additional pass/fail status information. Refer to [Section 2.5.5.2](#) for details regarding completion codes.

Figure 2-10. RdPkgConfig()



Note: The 2-byte parameter field and 4-byte read data field defined in [Figure 2-10](#) are sent in standard PECL ordering with LSB first and MSB last.

2.5.2.4.2 Supported Responses

The typical client response is a passing FCS, a passing Completion Code and valid data. Under some conditions, the client's response will indicate a failure.

Table 2-4. RdPkgConfig() Response Definition

Response	Meaning
Bad Write FCS	Electrical error
Abort FCS	Illegal command formatting (mismatched RL/WL/Command Code)
CC: 0x40	Command passed, data is valid.
CC: 0x80	Response timeout. The processor is not able to generate the required response in a timely fashion. Retry is appropriate.
CC: 0x81	Response timeout. The processor is not able to allocate resources for servicing this command at this time. Retry is appropriate.
CC: 0x90	Unknown/Invalid/Illegal Request
CC: 0x91	PECL control hardware, firmware or associated logic error. The processor is unable to process the request.

2.5.2.5 WrPkgConfig()

The WrPkgConfig() command provides write access to the package configuration space (PCS) within the processor, including various power and thermal management functions. Typical PCS write services supported by the processor may include power limiting, thermal averaging constant programming and so on. Refer to [Section 2.5.2.6](#) for more details on processor-specific services supported through this command.

2.5.2.5.1 Command Format

The WrPkgConfig() format is as follows:

Write Length: 0x0a(dword)



Read Length: 0x01

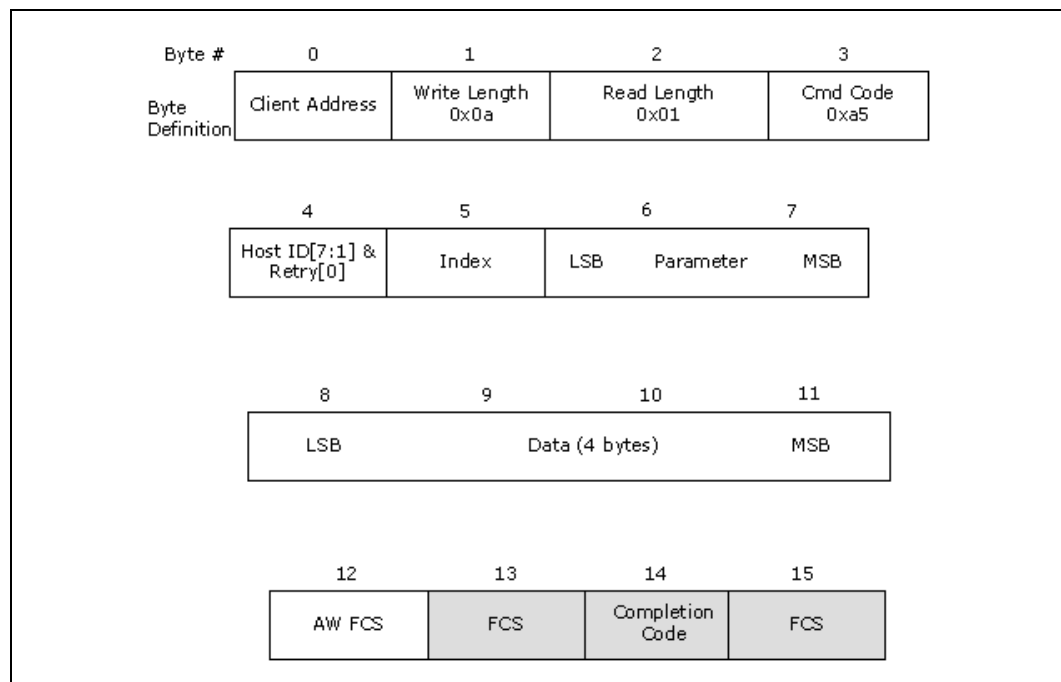
Command: 0xa5

AW FCS Support: Yes

Description: Writes data to the processor PCS entry as specified by the 'index' and 'parameter' fields. This command supports only dword data writes on the processor PECI clients. All command responses include a completion code that provides additional pass/fail status information. Refer to [Section 2.5.5.2](#) for details regarding completion codes.

The Assured Write FCS (AW FCS) support provides the processor client a high degree of confidence that the data it received from the host is correct. This is especially critical where the consumption of bad data might result in improper or non-recoverable operation.

Figure 2-11. WrPkgConfig()



Note: The 2-byte parameter field and 4-byte write data field defined in [Figure 2-11](#) are sent in standard PECI ordering with LSB first and MSB last.

2.5.2.5.2 Supported Responses

The typical client response is a passing FCS, a passing Completion Code and valid data. Under some conditions, the client's response will indicate a failure.

Table 2-5. WrPkgConfig() Response Definition (Sheet 1 of 2)

Response	Meaning
Bad Write FCS	Electrical error or AW FCS failure
Abort FCS	Illegal command formatting (mismatched RL/WL/Command Code)
CC: 0x40	Command passed, data is valid.



Table 2-5. WrPkgConfig() Response Definition (Sheet 2 of 2)

Response	Meaning
CC: 0x80	Response timeout. The processor was not able to generate the required response in a timely fashion. Retry is appropriate.
CC: 0x81	Response timeout. The processor is not able to allocate resources for servicing this command at this time. Retry is appropriate.
CC: 0x90	Unknown/Invalid/Illegal Request
CC: 0x91	PECI control hardware, firmware or associated logic error. The processor is unable to process the request.

2.5.2.6 Package Configuration Capabilities

Table 2-6 combines both read and write services. Any service listed as a “read” would use the RdPkgConfig() command and a service listed as a “write” would use the WrPkgConfig() command. PECI requests for memory temperature or other data generated outside the processor package do not trigger special polling cycles on the processor memory or SMBus interfaces to procure the required information.

2.5.2.6.1 DRAM Thermal and Power Optimization Capabilities

DRAM thermal and power optimization (also known as RAPL or “Running Average Power Limit”) services provide a way for platform thermal management solutions to program and access DRAM power, energy and temperature parameters. Memory temperature information is typically used to regulate fan speeds, tune refresh rates and throttle the memory subsystem as appropriate. Memory temperature data may be derived from a variety of sources including on-die or on-board DIMM sensors, DRAM activity information or a combination of the two. Though memory temperature data is a byte long, range of actual temperature values are determined by the DIMM specifications and operating range.

Note: DRAM related PECI services described in this section apply only to the memory connected to the specific processor PECI client in question and not the overall platform memory in general. For estimating DRAM thermal information in closed loop throttling mode, a dedicated SMBus is required between the CPU and the DIMMs. The processor PCU requires access to the VR12 voltage regulator for reading average output current information through the SVID bus for initial DRAM RAPL related power tuning.

Table 2-6 provides a summary of the DRAM power and thermal optimization capabilities that can be accessed over PECI on the processor. **The Index values referenced in Table 2-6 are in decimal format.**

Table 2-6 also provides information on alternate inband mechanisms to access similar or equivalent information through register reads and writes where applicable. The user should consult the *Intel® 64 and IA-32 Architectures Software Developer’s Manual (SDM) Volumes 1, 2, and 3* or *Intel® Xeon® Processor E5 Product Family Datasheet Volume Two* for details on MSR and CSR register contents.



Table 2-6. RdPkgConfig() & WrPkgConfig() DRAM Thermal and Power Optimization Services Summary (Sheet 1 of 2)

Service	Index Value (decimal)	Parameter Value (word)	RdPkgConfig() Data (dword)	WrPkgConfig() Data (dword)	Description	Alternate Inband MSR or CSR Access
DRAM Rank Temperature Write	18	Channel Index & DIMM Index	N/A	Absolute temperature in Degrees Celsius for ranks 0, 1, 2 & 3	Write temperature for each rank within a single DIMM.	N/A
DIMM Temperature Read	14	Channel Index	Absolute temperature in Degrees Celsius for DIMMs 0, 1, & 2	N/A	Read temperature of each DIMM within a channel.	CSR: DIMMTEMPSTAT_[0:2]
DIMM Ambient Temperature Write / Read	19	0x0000	N/A	Absolute temperature in Degrees C to be used as ambient temperature reference	Write ambient temperature reference for activity-based rank temperature estimation.	N/A
DIMM Ambient Temperature Write / Read	19	0x0000	Absolute temperature in Degrees C to be used as ambient temperature reference	N/A	Read ambient temperature reference for activity-based rank temperature estimation.	N/A
DRAM Channel Temperature Read	22	0x0000	Maximum of all rank temperatures for each channel in Degrees Celsius	N/A	Read the maximum DRAM channel temperature.	N/A
Accumulated DRAM Energy Read	04	Channel Index 0x00FF - All Channels	DRAM energy consumed by the DIMMs	N/A	Read the DRAM energy consumed by all the DIMMs in all the channels or all the DIMMs within a specified channel.	MSR 619h: DRAM_ENERGY_STATUS CSR: DRAM_ENERGY_STATUS CSR: DRAM_ENERGY_STATUS_C H[0:3] ¹
DRAM Power Info Read	35	0x0000	Typical and minimum DRAM power settings	N/A	Read DRAM power settings info to be used by power limiting entity.	MSR 61Ch: DRAM_POWER_INFO CSR: DRAM_POWER_INFO
DRAM Power Info Read	36	0x0000	Maximum DRAM power settings & maximum time window	N/A	Read DRAM power settings info to be used by power limiting entity	MSR 61Ch: DRAM_POWER_INFO CSR: DRAM_POWER_INFO



Table 2-6. RdPkgConfig() & WrPkgConfig() DRAM Thermal and Power Optimization Services Summary (Sheet 2 of 2)

Service	Index Value (decimal)	Parameter Value (word)	RdPkgConfig() Data (dword)	WrPkgConfig() Data (dword)	Description	Alternate Inband MSR or CSR Access
DRAM Power Limit Data Write / Read	34	0x0000	N/A	DRAM Plane Power Limit Data	Write DRAM Power Limit Data	MSR 618h: DRAM_POWER_LIMIT CSR: DRAM_PLANE_POWER_LIMIT
DRAM Power Limit Data Write / Read	34	0x0000	DRAM Plane Power Limit Data	N/A	Read DRAM Power Limit Data	MSR 618h: DRAM_POWER_LIMIT CSR: DRAM_PLANE_POWER_LIMIT
DRAM Power Limit Performance Status Read	38	0x0000	Accumulated DRAM throttle time	N/A	Read sum of all time durations for which each DIMM has been throttled	CSR: DRAM_RAPL_PERF_STATUS

Notes:

1. Time, energy and power units should be assumed, where applicable, to be based on values returned by a read of the PACKAGE_POWER_SKU_UNIT MSR or through the Package Power SKU Unit PCS read service.

2.5.2.6.2 DRAM Thermal Estimation Configuration Data Read/Write

This feature is relevant only when activity-based DRAM temperature estimation methods are being utilized and would apply to all the DIMMs on all the memory channels. The write allows the PECE host to configure the ‘β’ and ‘θ’ variables in [Figure 2-12](#) for DRAM channel temperature filtering as per the equation below:

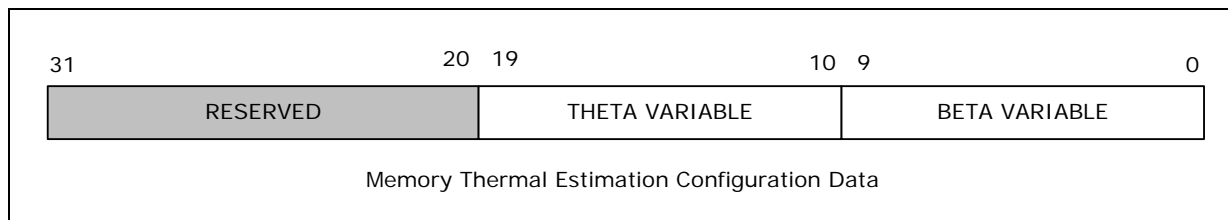
$$T_N = \beta * T_{N-1} + \theta * \Delta\text{Energy}$$

T_N and T_{N-1} are the current and previous DRAM temperature estimates respectively in degrees Celsius, ‘β’ is the DRAM temperature decay factor, ‘ΔEnergy’ is the energy difference between the current and previous memory transactions as determined by the processor power control unit and ‘θ’ is the DRAM energy-to-temperature translation coefficient. The default value of ‘β’ is 0x3FF. ‘θ’ is defined by the equation:

$$\theta = (1 - \beta) * (\text{Thermal Resistance}) * (\text{Scaling Factor})$$

The ‘Thermal Resistance’ serves as a multiplier for translation of DRAM energy changes to corresponding temperature changes and may be derived from actual platform characterization data. The ‘Scaling Factor’ is used to convert memory transaction information to energy units in Joules and can be derived from system/memory configuration information. Refer to the *Intel® 64 and IA-32 Architectures Software Developer’s Manual (SDM) Volumes 1, 2, and 3* for methods to program and access ‘Scaling Factor’ information.

Figure 2-12. DRAM Thermal Estimation Configuration Data





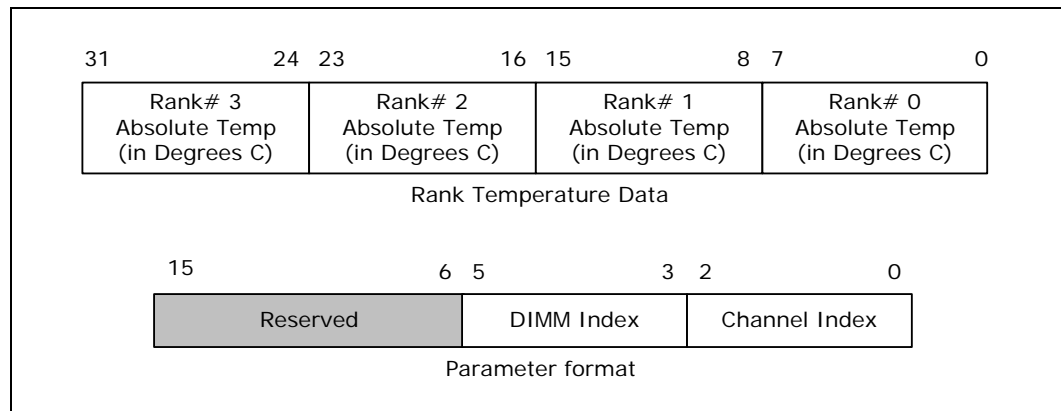
2.5.2.6.3 DRAM Rank Temperature Write

This feature allows the PECL host to program into the processor, the temperature for all the ranks within a DIMM up to a maximum of four ranks as shown in [Figure 2-13](#). The DIMM index and Channel index are specified through the parameter field as shown in [Table 2-7](#). This write is relevant in platforms that do not have on-die or on-board DIMM thermal sensors to provide memory temperature information or if the processor does not have direct access to the DIMM thermal sensors. This temperature information is used by the processor in conjunction with the activity-based DRAM temperature estimations.

Table 2-7. Channel & DIMM Index Decoding

Index Encoding	Physical Channel#	Physical DIMM#
000	0	0
001	1	1
010	2	2
011	3	Reserved

Figure 2-13. DRAM Rank Temperature Write Data

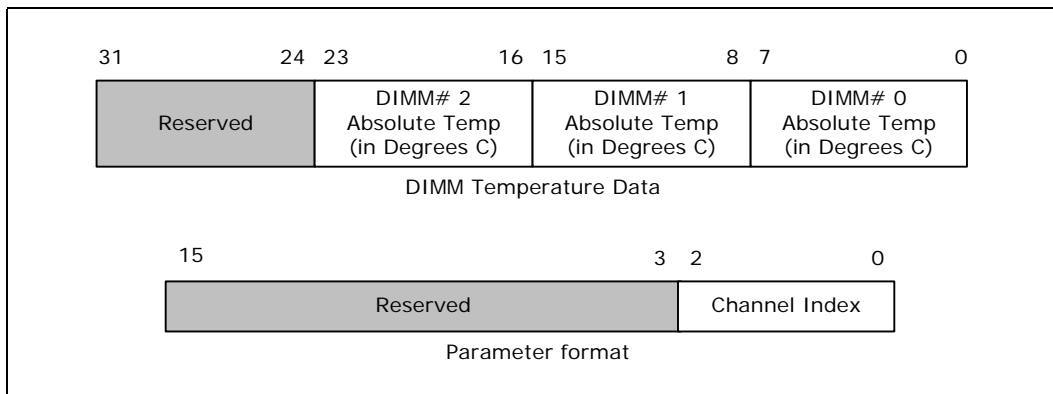


2.5.2.6.4 DIMM Temperature Read

This feature allows the PECL host to read the temperature of all the DIMMs within a channel up to a maximum of three DIMMs. This read is not limited to platforms using a particular memory temperature source or temperature estimation method. For platforms using DRAM thermal estimation, the PCU will provide the estimated temperatures. Otherwise, the data represents the latest DIMM temperature provided by the TSOD or on-board DIMM sensor and requires that CLTT (closed loop throttling mode) be enabled and OLTT (open loop throttling mode) be disabled. Refer to [Table 2-7](#) for channel index encodings.



Figure 2-14. The Processor DIMM Temperature Read / Write

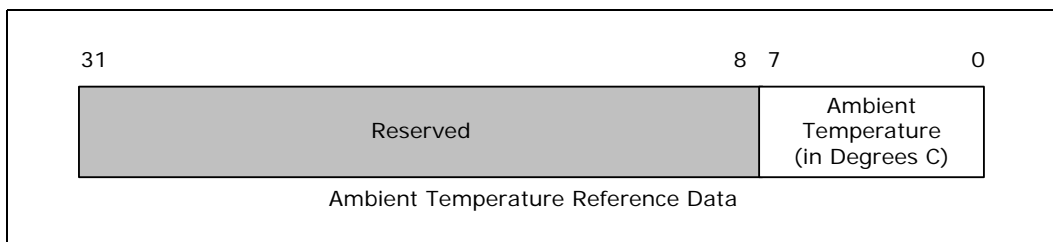


2.5.2.6.5 DIMM Ambient Temperature Write / Read

This feature allows the PECE host to provide an ambient temperature reference to be used by the processor for activity-based DRAM temperature estimation. This write is used only when no DIMM temperature information is available from on-board or on-die DIMM thermal sensors. It is also possible for the PECE host controller to read back the DIMM ambient reference temperature.

Since the ambient temperature may vary over time within a system, it is recommended that systems monitoring and updating the ambient temperature at a fast rate use the 'maximum' temperature value while those updating the ambient temperature at a slow rate use an 'average' value. The ambient temperature assumes a single value for all memory channel/DIMM locations and does not account for possible temperature variations based on DIMM location.

Figure 2-15. Ambient Temperature Reference Data

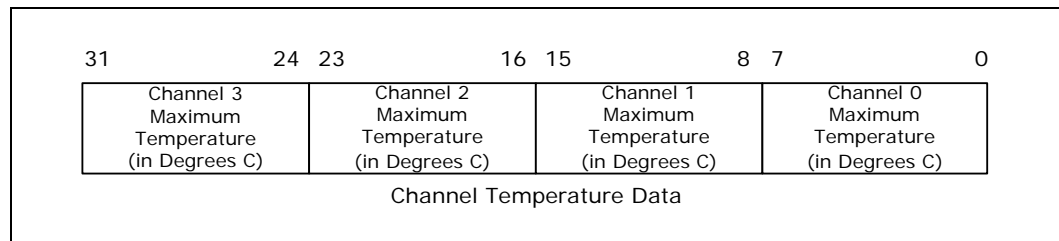


2.5.2.6.6 DRAM Channel Temperature Read

This feature enables a PECE host read of the maximum temperature of each channel. This would include all the DIMMs within the channel and all the ranks within each of the DIMMs. Channels that are not populated will return the 'ambient temperature' on systems using activity-based temperature estimations or alternatively return a 'zero' for systems using sensor-based temperatures.



Figure 2-16. Processor DRAM Channel Temperature

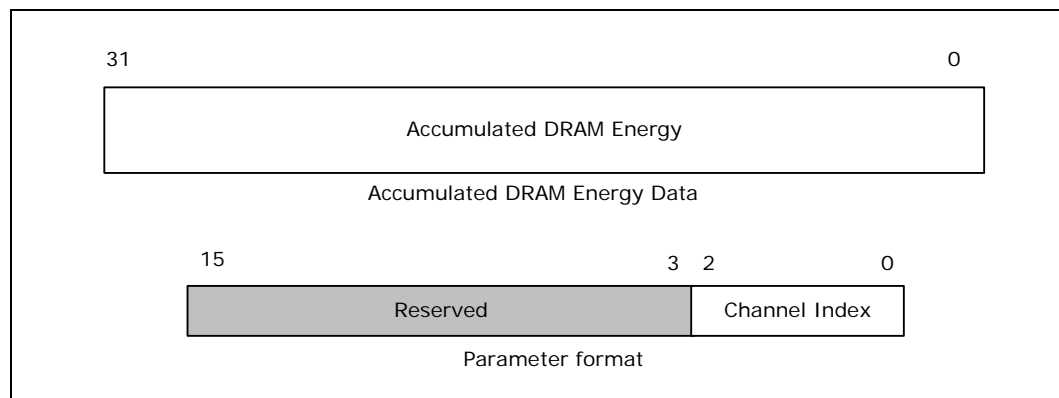


2.5.2.6.7 Accumulated DRAM Energy Read

This feature allows the PECC host to read the DRAM energy consumed by all the DIMMs within all the channels or all the DIMMs within just a specified channel. The parameter field is used to specify the channel index. Units used are defined as per the Package Power SKU Unit read described in [Section 2.5.2.6.11](#). This information is tracked by a 32-bit counter that wraps around. The channel index in [Figure 2-17](#) is specified as per the index encoding described in [Table 2-7](#). A channel index of 0x00FF is used to specify the “all channels” case. While Intel requires reading the accumulated energy data at least once every 16 seconds to ensure functional correctness, a more realistic polling rate recommendation is once every 100 mS for better accuracy. This feature assumes a 200W memory capacity. In general, as the power capability decreases, so will the minimum polling rate requirement.

When determining energy changes by subtracting energy values between successive reads, Intel advocates using the 2’s complement method to account for counter wrap-arounds. Alternatively, adding all ‘F’s (‘0xFFFFFFFF’) to a negative result from the subtraction will accomplish the same goal.

Figure 2-17. Accumulated DRAM Energy Data



2.5.2.6.8 DRAM Power Info Read

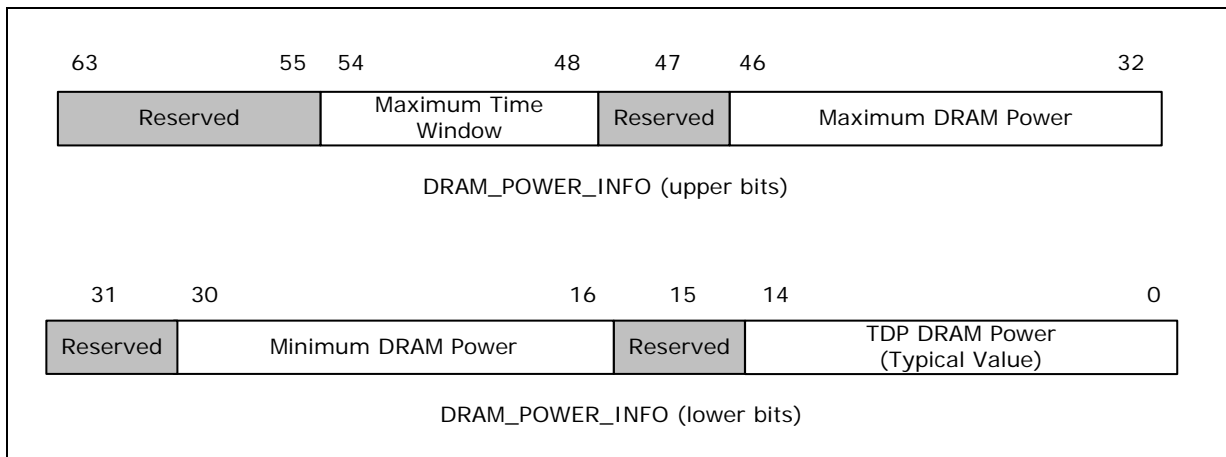
This read returns the minimum, typical and maximum DRAM power settings and the maximum time window over which the power can be sustained for the entire DRAM domain and is inclusive of all the DIMMs within all the memory channels. Any power values specified by the power limiting entity that is outside of the range specified through these settings cannot be guaranteed. Since this data is 64 bits wide, PECC facilitates access to this register by allowing two requests to read the lower 32 bits and upper 32 bits separately as shown in [Table 2-6](#). Power and time units for this read are defined as per the Package Power SKU Unit settings described in [Section 2.5.2.6.11](#).



The minimum DRAM power in [Figure 2-18](#) corresponds to a minimum bandwidth setting of the memory interface. It does 'not' correspond to a processor IDLE or memory self-refresh state. The 'time window' in [Figure 2-18](#) is representative of the rate at which the power control unit (PCU) samples the DRAM energy consumption information and reactively takes the necessary measures to meet the imposed power limits. Programming too small a time window may not give the PCU enough time to sample energy information and enforce the limit while too large a time window runs the risk of the PCU not being able to monitor and take timely action on energy excursions. While the DRAM power setting in [Figure 2-18](#) provides a maximum value for the 'time window' (typically a few seconds), the minimum value may be assumed to be ~100 mS.

The PCU programs the DRAM power settings described in [Figure 2-18](#) when DRAM characterization has been completed by the memory reference code (MRC) during boot as indicated by the setting of the RST_CPL bit of the BIOS_RESET_CPL register. The DRAM power settings will be programmed during boot independent of the 'DRAM Power Limit Enable' bit setting. Please refer to the *Intel® Xeon® Processor E5 Product Family Datasheet Volume Two* for information on memory energy estimation methods and energy tuning options used by BIOS and other utilities for determining the range specified in the DRAM power settings. In general, any tuning of the power settings is done by polling the voltage regulators supplying the DIMMs.

Figure 2-18. DRAM Power Info Read Data



2.5.2.6.9 DRAM Power Limit Data Write / Read

This feature allows the PECL host to program the power limit over a specified time or control window for the entire DRAM domain covering all the DIMMs within all the memory channels. Actual values are chosen based on DRAM power consumption characteristics. The units for the DRAM Power Limit and Control Time Window are determined as per the Package Power SKU Unit settings described in [Section 2.5.2.6.11](#). The DRAM Power Limit Enable bit in [Figure 2-19](#) should be set to activate this feature. Exact DRAM power limit values are largely determined by platform memory configuration. As such, this feature is disabled by default and there are no defaults associated with the DRAM power limit values. The PECL host may be used to enable and initialize the power limit fields for the purposes of DRAM power budgeting. Alternatively, this can also be accomplished through inband writes to the appropriate registers. Both power limit enabling and initialization of power limit values can be done in the same command cycle. All RAPL parameter values including the power limit value, control time window, and enable bit will have to be specified correctly even if the intent is to change just one parameter value when programming over PECL.



The following conversion formula should be used for encoding or programming the 'Control Time Window' in bits [23:17].

$$\text{Control Time Window (in seconds)} = ([1 + 0.25 * 'x'] * 2^y) * 'z'$$
 where

'x' = integer value of bits[23:22]

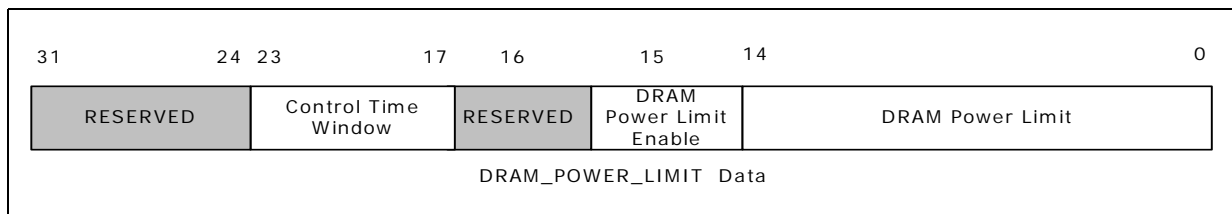
'y' = integer value of bits[21:17]

'z' = Package Power SKU Time Unit[19:16] (see [Section 2.5.2.6.13](#) for details on Package Power SKU Unit)

For example, using this formula, a control time value of 0x0A will correspond to a '1-second' time window. A valid range for the value of the 'Control Time Window' in [Figure 2-19](#) that can be programmed into bits [23:17] is 250 mS - 40 seconds.

From a DRAM power management standpoint, all post-boot DRAM power management activities (also referred to as 'DRAM RAPL' or 'DRAM Running Average Power Limit') should be managed exclusively through a single interface like PECCI or alternatively an inband mechanism. If PECCI is being used to manage DRAM power budgeting activities, BIOS should lock out all subsequent inband DRAM power limiting accesses by setting bit 31 of the DRAM_POWER_LIMIT MSR or DRAM_PLANE_POWER_LIMIT CSR to '1'.

Figure 2-19. DRAM Power Limit Data

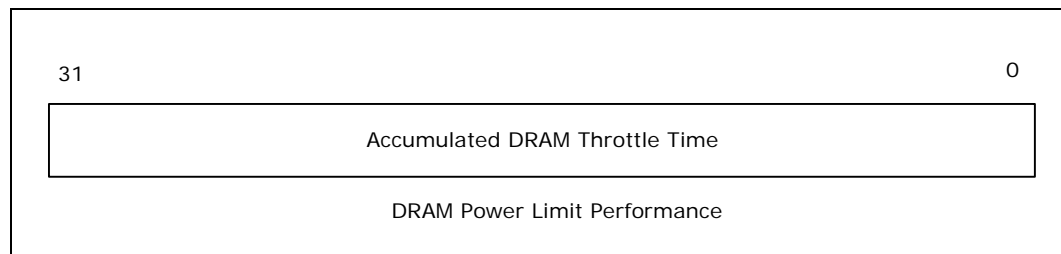


2.5.2.6.10 DRAM Power Limit Performance Status Read

This service allows the PECCI host to assess the performance impact of the currently active DRAM power limiting modes. The read return data contains the sum of all the time durations for which each of the DIMMs has been operating in a low power state. This information is tracked by a 32-bit counter that wraps around. The unit for time is determined as per the Package Power SKU Unit settings described in [Section 2.5.2.6.11](#). The DRAM performance data does not account for stalls on the memory interface.

In general, for the purposes of DRAM RAPL, the DRAM power management entity should use PECCI accesses to DRAM energy and performance status in conjunction with the power limiting feature to budget power between the various memory sub-systems in the server system.

Figure 2-20. DRAM Power Limit Performance Data





2.5.2.6.11 CPU Thermal and Power Optimization Capabilities

Table 2-8 provides a summary of the processor power and thermal optimization capabilities that can be accessed over PECC.

Note: The Index values referenced in Table 2-8 are in decimal format.

Table 2-8 also provides information on alternate inband mechanisms to access similar or equivalent information for register reads and writes where applicable. The user should consult the appropriate *Intel® 64 and IA-32 Architectures Software Developer's Manual (SDM) Volumes 1, 2, and 3* or *Intel® Xeon® Processor E5 Product Family Datasheet Volume Two* for exact details on MSR or CSR register content.

Table 2-8. RdPkgConfig() & WrPkgConfig() CPU Thermal and Power Optimization Services Summary (Sheet 1 of 3)

Service	Index Value (decimal)	Parameter Value (word)	RdPkgConfig() Data (dword)	WrPkgConfig() Data (dword)	Description	Alternate Inband MSR or CSR Access
Package Identifier Read	00	0x0000	CPUID Information		Returns processor-specific information including CPU family, model and stepping information.	Execute CPUID instruction to get processor signature
		0x0001	Platform ID		Used to ensure microcode update compatibility with processor.	MSR 17h: IA32_PLATFORM_ID
		0x0002	PCU Device ID		Returns the Device ID information for the processor Power Control Unit.	CSR: DID
		0x0003	Max Thread ID		Returns the maximum 'Thread ID' value supported by the processor.	MSR: RESOLVED_CORES_MASK CSR: RESOLVED_CORES_MASK
		0x0004	CPU Microcode Update Revision		Returns processor microcode and PCU firmware revision information.	MSR 8Bh: IA32_BIOS_SIGN_ID
		0x0005	MCA Error Source Log		Returns the MCA Error Source Log	CSR: MCA_ERR_SRC_LOG
Package Power SKU Unit Read	30	0x0000	Time, Energy and Power Units	N/A	Read units for power, energy and time used in power control registers.	MSR 606h: PACKAGE_POWER_SKU_UNIT CSR: PACKAGE_POWER_SKU_UNIT
Package Power SKU Read	28	0x0000	Package Power SKU[31:0]	N/A	Returns Thermal Design Power and minimum package power values for the processor SKU.	MSR 614h: PACKAGE_POWER_SKU CSR: PACKAGE_POWER_SKU
Package Power SKU Read	29	0x0000	Package Power SKU[64:32]	N/A	Returns the maximum package power value for the processor SKU and the maximum time interval for which it can be sustained.	MSR 614h: PACKAGE_POWER_SKU CSR: PACKAGE_POWER_SKU
"Wake on PECC" Mode Bit Write / Read	05	0x0001 - Set 0x0000 - Reset	N/A	"Wake on PECC" mode bit	Enables package pop-up to C2 to service PECC PCIConfig() accesses if appropriate.	N/A



Table 2-8. RdPkgConfig() & WrPkgConfig() CPU Thermal and Power Optimization Services Summary (Sheet 2 of 3)

Service	Index Value (decimal)	Parameter Value (word)	RdPkgConfig() Data (dword)	WrPkgConfig() Data (dword)	Description	Alternate Inband MSR or CSR Access
"Wake on PECL" Mode Bit Write / Read	05	0x0000	"Wake on PECL" mode bit	N/A	Read status of "Wake on PECL" mode bit	N/A
Accumulated Run Time Read	31	0x0000	Total reference time	N/A	Returns the total run time.	MSR 10h: IA32_TIME_STAMP_COUNTER
Package Temperature Read	02	0x00FF	Processor package Temperature	N/A	Returns the maximum processor die temperature in PECL format.	MSR 1B1h: IA32_PACKAGE_THERM_STATUS
Per Core DTS Temperature Read	09	0x0000-0x0007 (cores 0-7) 0x00FF - System Agent	Per core DTS maximum temperature	N/A	Read the maximum DTS temperature of a particular core or the System Agent within the processor die in relative PECL temperature format	MSR 19Ch: IA32_THERM_STATUS
Temperature Target Read	16	0x0000	Processor T_{jmax} and $T_{CONTROL}$	N/A	Returns the maximum processor junction temperature and processor $T_{CONTROL}$.	MSR 1A2h: TEMPERATURE_TARGET CSR: TEMPERATURE_TARGET
Package Thermal Status Read / Clear	20	0x0000	Thermal Status Register	N/A	Read the thermal status register and optionally clear any log bits. The register includes status and log bits for TCC activation, PROCHOT_N assertion and Critical Temperature.	MSR 1B1h: IA32_PACKAGE_THERM_STATUS
Thermal Averaging Constant Write / Read	21	0x0000	Thermal Averaging Constant	N/A	Reads the Thermal Averaging Constant	N/A
Thermal Averaging Constant Write / Read	21	0x0000	N/A	Thermal Averaging Constant	Writes the Thermal Averaging Constant	N/A
Thermally Constrained Time Read	32	0x0000	Thermally Constrained Time	N/A	Read the time for which the processor has been operating in a lowered power state due to internal TCC activation.	N/A
Current Limit Read	17	0x0000	Current Limit per power plane	N/A	Reads the current limit on the VCC power plane	CSR: PRIMARY_PLANE_CURRENT_CONFIG_CONTROL
Accumulated Energy Status Read	03	0x0000 - VCC 0x00FF - CPU package	Accumulated CPU energy	N/A	Returns the value of the energy consumed by just the VCC power plane or entire CPU package.	MSR 639h: PPO_ENERGY_STATUS CSR: PPO_ENERGY_STATUS MSR 611h: PACKAGE_ENERGY_STATUS CSR: PACKAG_ENERGY_STATUS
Power Limit for the VCC Power Plane Write / Read	25	0x0000	N/A	Power Limit Data	Program power limit for VCC power plane	MSR 638h: PPO_POWER_LIMIT CSR: PPO_POWER_LIMIT



Table 2-8. RdPkgConfig() & WrPkgConfig() CPU Thermal and Power Optimization Services Summary (Sheet 3 of 3)

Service	Index Value (decimal)	Parameter Value (word)	RdPkgConfig() Data (dword)	WrPkgConfig() Data (dword)	Description	Alternate Inband MSR or CSR Access
Power Limit for the VCC Power Plane Write / Read	25	0x0000	Power Limit Data	N/A	Read power limit data for VCC power plane	MSR 638h: PPO_POWER_LIMIT CSR: PPO_POWER_LIMIT
Package Power Limits For Multiple Turbo Modes	26	0x0000	N/A	Power Limit 1 Data	Write power limit data 1 in multiple turbo mode.	MSR 610h: PACKAGE_POWER_LIMIT CSR: PACKAGE_POWER_LIMIT
Package Power Limits For Multiple Turbo Modes	27	0x0000	N/A	Power Limit 2 Data	Write power limit data 2 in multiple turbo mode.	MSR 610h: PACKAGE_POWER_LIMIT CSR: PACKAGE_POWER_LIMIT
Package Power Limits For Multiple Turbo Modes	26	0x0000	Power Limit 1 Data	N/A	Read power limit 1 data in multiple turbo mode.	MSR 610h: PACKAGE_POWER_LIMIT CSR: PACKAGE_POWER_LIMIT
Package Power Limits For Multiple Turbo Modes	27	0x0000	Power Limit 2 Data	N/A	Read power limit 2 data in multiple turbo mode.	MSR 610h: PACKAGE_POWER_LIMIT CSR: PACKAGE_POWER_LIMIT
Package Power Limit Performance Status Read	08	0x00FF - CPU package	Accumulated CPU throttle time	N/A	Read the total time for which the processor package was throttled due to power limiting.	CSR: PACKAGE_RAPL_PERF_STATUS
Efficient Performance Indicator Read	06	0x0000	Number of productive processor cycles	N/A	Read number of productive cycles for power budgeting purposes.	N/A
ACPI P-T Notify Write & Read	33	0x0000	N/A	New p-state equivalent of P1 used in conjunction with package power limiting	Notify the processor PCU of the new p-state that is one state below the turbo frequency as specified through the last ACPI Notify	N/A
ACPI P-T Notify Write & Read	33	0x0000	New p-state equivalent of P1 used in conjunction with package power limiting	N/A	Read the processor PCU to determine the p-state that is one state below the turbo frequency as specified through the last ACPI Notify	N/A
Caching Agent TOR Read	39	Cbo Index, TOR Index, Bank#; Read Mode	Caching Agent (Cbo) Table of Requests (TOR) data; Core ID & associated valid bit	N/A	Read the Cbo TOR data for all enabled cores in the event of a 3-strike timeout. Can alternatively be used to read 'Core ID' data to confirm that IERR was caused by a core timeout	N/A
Thermal Margin Read	10	0x0000	Thermal margin to processor thermal profile or load line	N/A	Read margin to processor thermal load line	N/A

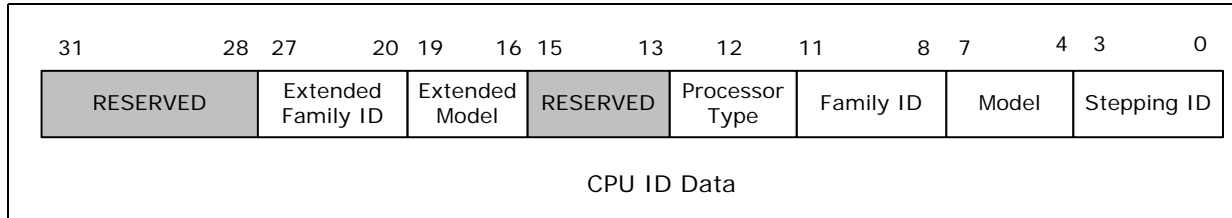


2.5.2.6.12 Package Identifier Read

This feature enables the PECI host to uniquely identify the PECI client processor. The parameter field encodings shown in [Table 2-8](#) allow the PECI host to access the relevant processor information as described below.

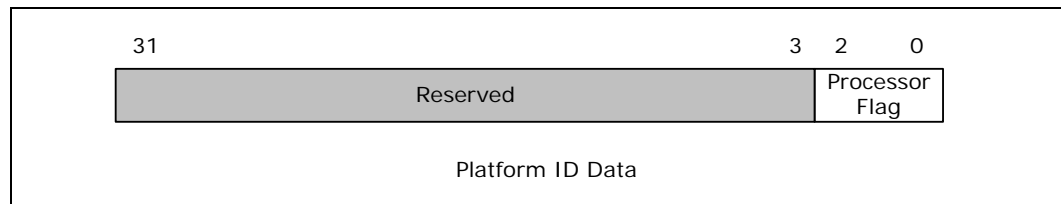
- **CPUID data:** This is the equivalent of data that can be accessed through the CPUID instruction execution. It contains processor type, stepping, model and family ID information as shown in [Figure 2-21](#).

Figure 2-21. CPUID Data



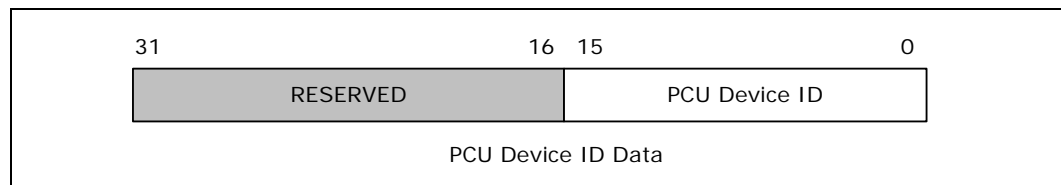
- **Platform ID data:** The Platform ID data can be used to ensure processor microcode updates are compatible with the processor. The value of the Platform ID or Processor Flag[2:0] as shown in [Figure 2-22](#) is typically unique to the platform type and processor stepping. Refer to the *Intel® 64 and IA-32 Architectures Software Developer's Manual (SDM) Volumes 1, 2, and 3* for more information.

Figure 2-22. Platform ID Data



- **PCU Device ID:** This information can be used to uniquely identify the processor power control unit (PCU) device when combined with the Vendor Identification register content and remains constant across all SKUs. Refer to the appropriate register description for the exact processor PCU Device ID value.

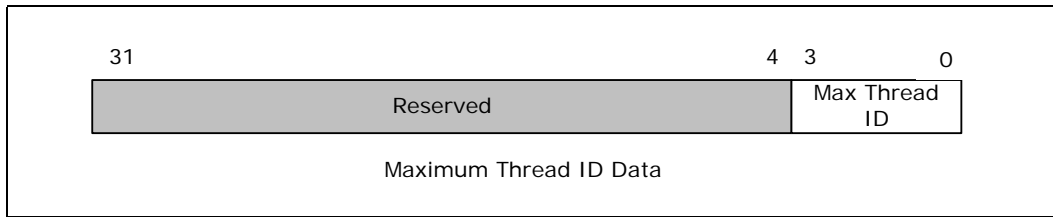
Figure 2-23. PCU Device ID



- **Max Thread ID:** The maximum Thread ID data provides the number of supported processor threads. This value is dependent on the number of cores within the processor as determined by the processor SKU and is independent of whether certain cores or corresponding threads are enabled or disabled.

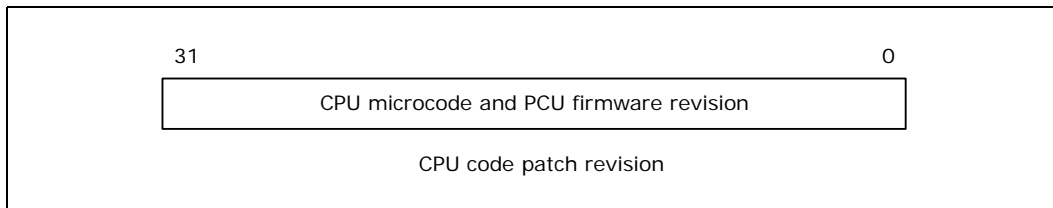


Figure 2-24. Maximum Thread ID



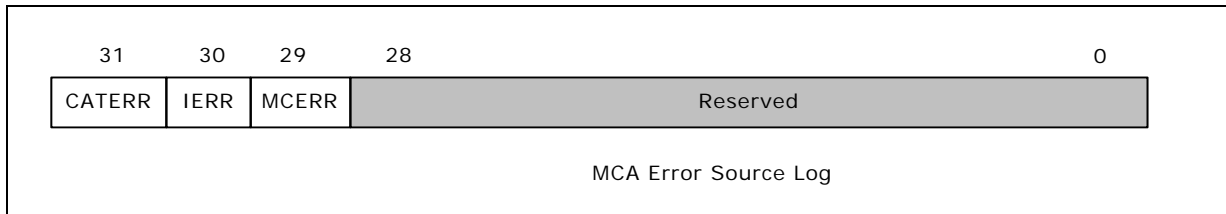
- **CPU Microcode Update Revision:** Reflects the revision number for the microcode update and power control unit firmware updates on the processor sample. The revision data is a unique 32-bit identifier that reflects a combination of specific versions of the processor microcode and PCU control firmware.

Figure 2-25. Processor Microcode Revision



- **Machine Check Status:** Returns error information as logged by the MCA Error Source Log register. See Figure 2-26 for details. The power control unit will assert the relevant bit when the error condition represented by the bit occurs. For example, bit 29 will be set if the package asserted MCERR, bit 30 is set if the package asserted IERR and bit 31 is set if the package asserted CAT_ERR_N. The CAT_ERR_N may be used to signal the occurrence of a MCERR or IERR.

Figure 2-26. Machine Check Status



2.5.2.6.13 Package Power SKU Unit Read

This feature enables the PECCI host to read the units of time, energy and power used in the processor and DRAM power control registers for calculating power and timing parameters. In Figure 2-27, the default value of the power unit field [3:0] is 0011b, energy unit [12:8] is 10000b and the time unit [19:16] is 1010b. Actual unit values are calculated as shown in Table 2-9.

Figure 2-27. Package Power SKU Unit Data

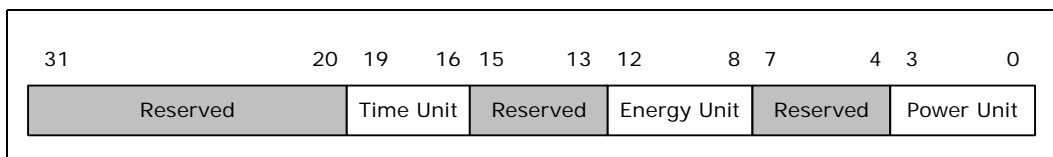




Table 2-9. Power Control Register Unit Calculations

Unit Field	Value Calculation	Default Value
Time	$1s / 2^{\text{TIME UNIT}}$	$1s / 2^{10} = 976 \mu s$
Energy	$1J / 2^{\text{ENERGY UNIT}}$	$1J / 2^{16} = 15.3 \mu J$
Power	$1W / 2^{\text{POWER UNIT}}$	$1W / 2^3 = 1/8 W$

2.5.2.6.14 Package Power SKU Read

This read allows the PECE host to access the minimum, Thermal Design Power and maximum power settings for the processor package SKU. It also returns the maximum time interval or window over which the power can be sustained. If the power limiting entity specifies a power limit value outside of the range specified through these settings, power regulation cannot be guaranteed. Since this data is 64 bits wide, PECE facilitates access to this register by allowing two requests to read the lower 32 bits and upper 32 bits separately as shown in [Table 2-8](#). Power units for this read are determined as per the Package Power SKU Unit settings described in [Section 2.5.2.6.13](#).

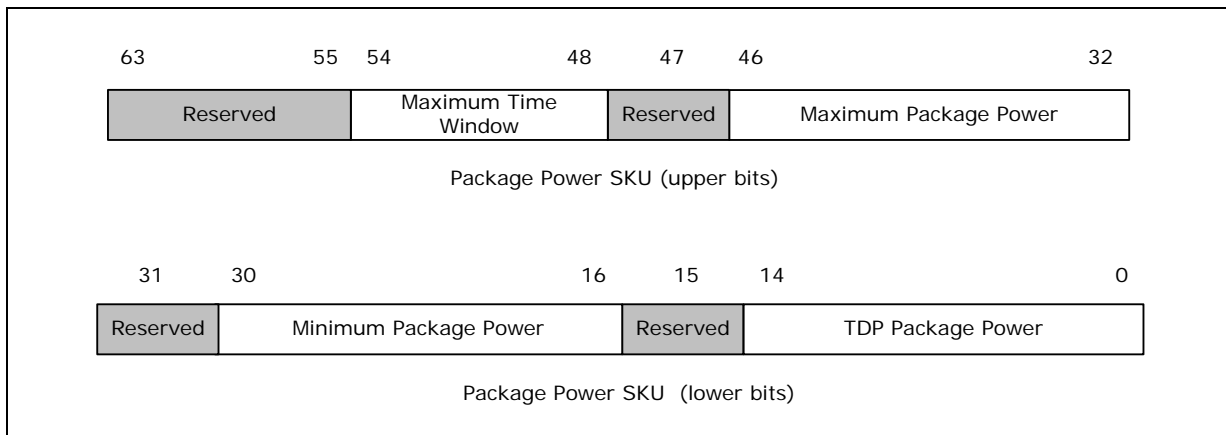
'Package Power SKU data' is programmed by the PCU firmware during boot time based on SKU dependent power-on default values set during manufacturing. The TDP package power specified through bits [14:0] in [Figure 2-28](#) is the maximum value of the 'Power Limit1' field in [Section 2.5.2.6.26](#) while the maximum package power in bits [46:32] is the maximum value of the 'Power Limit2' field.

The minimum package power in bits [30:16] is applicable to both the 'Power Limit1' & 'Power Limit2' fields and corresponds to a mode when all the cores are operational and in their lowest frequency mode. Attempts to program the power limit below the minimum power value may not be effective since BIOS/OS, and not the PCU, controls disabling of cores and core activity.

The 'maximum time window' in bits [54:48] is representative of the maximum rate at which the power control unit (PCU) can sample the package energy consumption and reactively take the necessary measures to meet the imposed power limits. Programming too large a time window runs the risk of the PCU not being able to monitor and take timely action on package energy excursions. On the other hand, programming too small a time window may not give the PCU enough time to sample energy information and enforce the limit. The minimum value of the 'time window' can be obtained by reading bits [21:15] of the PWR_LIMIT_MISC_INFO CSR using the PECE RdPCICongfigLocal() command.



Figure 2-28. Package Power SKU Data



2.5.2.6.15 “Wake on PECl” Mode Bit Write / Read

Setting the “Wake on PECl” mode bit enables successful completion of the WrPClConfigLocal(), RdPClConfigLocal(), WrPClConfig() and RdPClConfig() PECl commands by forcing a package ‘pop-up’ to the C2 state to service these commands if the processor is in a low-power state. The exact power impact of such a ‘pop-up’ is determined by the product SKU, the C-state from which the pop-up is initiated and the negotiated PECl bit rate. A ‘reset’ or ‘clear’ of this bit or simply not setting the “Wake on PECl” mode bit could result in a “timeout” response (completion code of 0x82) from the processor indicating that the resources required to service the command are in a low power state.

Alternatively, this mode bit can also be read to determine PECl behavior in package states C3 or deeper.

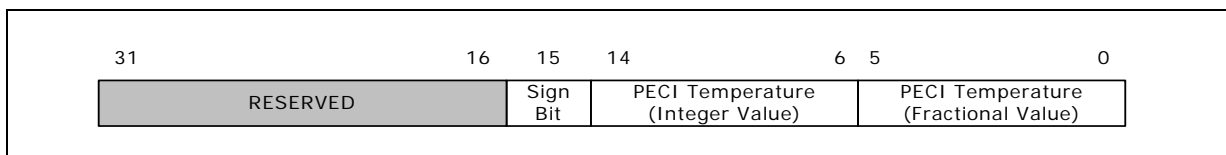
2.5.2.6.16 Accumulated Run Time Read

This read returns the total time for which the processor has been executing with a resolution of 1 mS per count. This is tracked by a 32-bit counter that rolls over on reaching the maximum value. This counter activates and starts counting for the first time at RESET_N de-assertion.

2.5.2.6.17 Package Temperature Read

This read returns the maximum processor die temperature in 16-bit PECl format. The upper 16 bits of the response data are reserved. The PECl temperature data returned by this read is the ‘instantaneous’ value and not the ‘average’ value as returned by the PECl GetTemp() described in Section 2.5.2.3.

Figure 2-29. Package Temperature Read Data





2.5.2.6.18 Per Core DTS Temperature Read

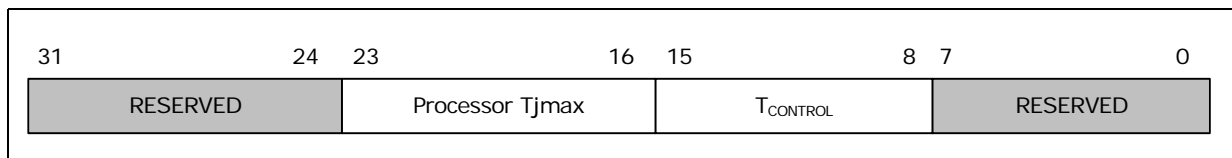
This feature enables the PECE host to read the maximum value of the DTS temperature for any specific core within the processor. Alternatively, this service can be used to read the System Agent temperature. Temperature is returned in the same format as the Package Temperature Read described in [Section 2.5.2.6.17](#). Data is returned in relative PECE temperature format.

Reads to a parameter value outside the supported range will return an error as indicated by a completion code of 0x90. The supported range of parameter values can vary depending on the number of cores within the processor. The temperature data returned through this feature is the instantaneous value and not an averaged value. It is updated once every 1 mS.

2.5.2.6.19 Temperature Target Read

The Temperature Target Read allows the PECE host to access the maximum processor junction temperature (T_{jmax}) in degrees Celsius. This is also the default temperature value at which the processor thermal control circuit activates. The T_{jmax} value may vary from processor part to part to reflect manufacturing process variations. The Temperature Target read also returns the processor $T_{CONTROL}$ value. $T_{CONTROL}$ is returned in standard PECE temperature format and represents the threshold temperature used by the thermal management system for fan speed control.

Figure 2-30. Temperature Target Read



2.5.2.6.20 Package Thermal Status Read / Clear

The Thermal Status Read provides information on package level thermal status. Data includes:

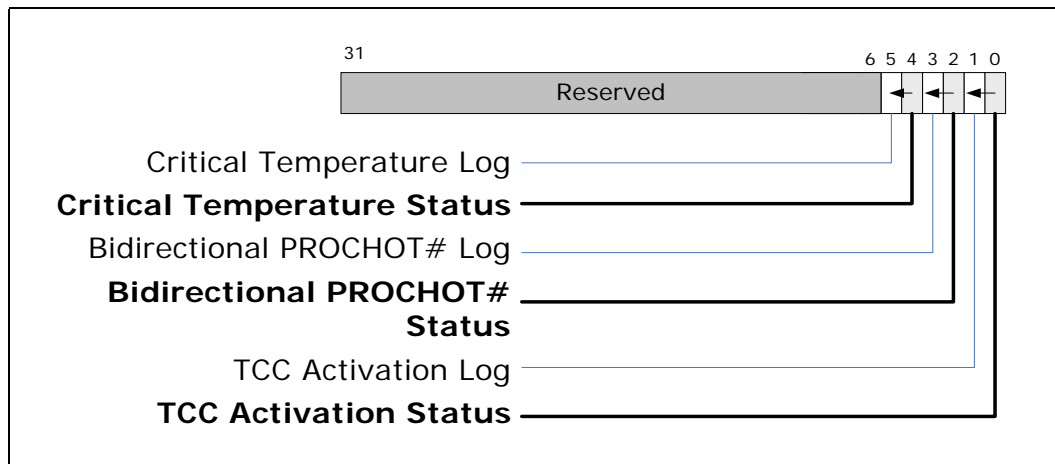
- Thermal Control Circuit (TCC) activation
- Bidirectional PROCHOT_N signal assertion
- Critical Temperature

Both status and sticky log bits are managed in this status word. All sticky log bits are set upon a rising edge of the associated status bit and the log bits are cleared only by Thermal Status reads or a processor reset. A read of the Thermal Status word always includes a log bit clear mask that allows the host to clear any or all of the log bits that it is interested in tracking.

A bit set to '0' in the log bit clear mask will result in clearing the associated log bit. If a mask bit is set to '0' and that bit is not a legal mask, a failing completion code will be returned. A bit set to '1' is ignored and results in no change to any sticky log bits. For example, to clear the TCC Activation Log bit and retain all other log bits, the Thermal Status Read should send a mask of 0xFFFFFD.



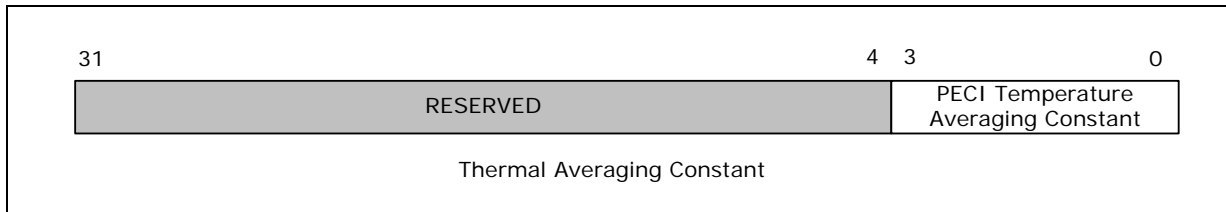
Figure 2-31. Thermal Status Word



2.5.2.6.21 Thermal Averaging Constant Write / Read

This feature allows the PECI host to control the window over which the estimated processor PECI temperature is filtered. The host may configure this window as a power of two. For example, programming a value of 5 results in a filtering window of 2^5 or 32 samples. The maximum programmable value is 8 or 256 samples. Programming a value of zero would disable the PECI temperature averaging feature. The default value of the thermal averaging constant is 4 which translates to an averaging window size of 2^4 or 16 samples. More details on the PECI temperature filtering function can be found in Section 2.5.7.3.

Figure 2-32. Thermal Averaging Constant Write / Read



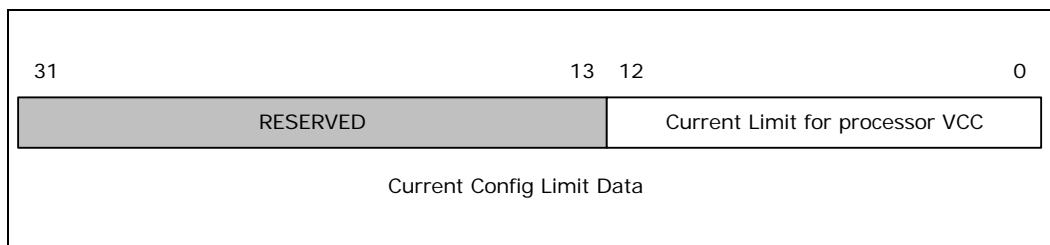
2.5.2.6.22 Thermally Constrained Time Read

This features allows the PECI host to access the total time for which the processor has been operating in a lowered power state due to TCC activation. The returned data includes the time required to ramp back up to the original P-state target after TCC activation expires. This timer does not include TCC activation as a result of an external assertion of PROCHOT_N. This is tracked by a 32-bit counter with a resolution of 1mS per count that rolls over or wraps around. On the processor PECI clients, the only logic that can be thermally constrained is that supplied by VCC.

2.5.2.6.23 Current Limit Read

This read returns the current limit for the processor VCC power plane in 1/8A increments. Actual current limit data is contained only in the lower 13 bits of the response data. The default return value of 0x438 corresponds to a current limit value of 135A.

Figure 2-33. Current Config Limit Read Data



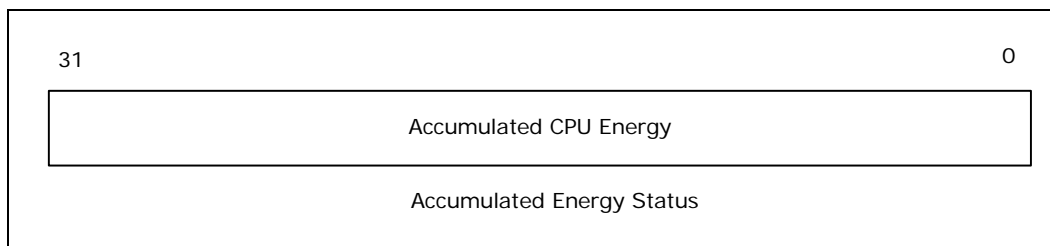
2.5.2.6.24 Accumulated Energy Status Read

This service can return the value of the total energy consumed by the entire processor package or just the logic supplied by the VCC power plane as specified through the parameter field in [Table 2-8](#). This information is tracked by a 32-bit counter that wraps around and continues counting on reaching its limit. Energy units for this read are determined as per the Package Power SKU Unit settings described in [Section 2.5.2.6.13](#).

While Intel requires reading the accumulated energy data at least once every 16 seconds to ensure functional correctness, a more realistic polling rate recommendation is once every 100mS for better accuracy. This feature assumes a 150W processor. In general, as the power capability decreases, so will the minimum polling rate requirement.

When determining energy changes by subtracting energy values between successive reads, Intel advocates using the 2's complement method to account for counter wrap-arounds. Alternatively, adding all 'F's ('0xFFFFFFFF') to a negative result from the subtraction will accomplish the same goal.

Figure 2-34. Accumulated Energy Read Data



2.5.2.6.25 Power Limit for the VCC Power Plane Write / Read

This feature allows the PECL host to program the power limit over a specified time or control window for the processor logic supplied by the VCC power plane. This typically includes all the cores, home agent and last level cache. The processor does not support power limiting on a per-core basis. Actual power limit values are chosen based on the external VR (voltage regulator) capabilities. The units for the Power Limit and Control Time Window are determined as per the Package Power SKU Unit settings described in [Section 2.5.2.6.13](#).

Since the exact VCC plane power limit value is a function of the platform VR, this feature is not enabled by default and there are no default values associated with the power limit value or the control time window. The Power Limit Enable bit in [Figure 2-35](#) should be set to activate this feature. The Clamp Mode bit is also required to be set to allow the cores to go into power states below what the operating system originally requested. In general, this feature provides an improved mechanism for VR protection

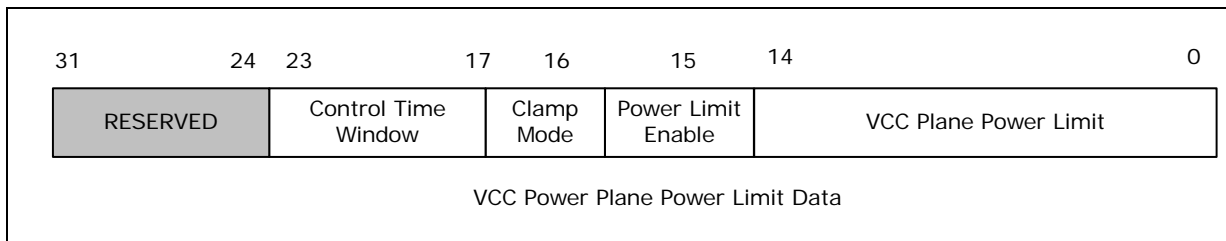


compared to the input PROCHOT_N signal assertion method. Both power limit enabling and initialization of power limit values can be done in the same command cycle. Setting a power limit for the VCC plane enables turbo modes for associated logic. External VR protection is guaranteed during boot through operation at safe voltage and frequency. All RAPL parameter values including the power limit value, control time window, clamp mode and enable bit will have to be specified correctly even if the intent is to change just one parameter value when programming over PECI.

The usefulness of the VCC power plane RAPL may be somewhat limited if the platform has a fully compliant external voltage regulator. However, platforms using lower cost voltage regulators may find this feature useful. The VCC RAPL value is generally expected to be a static value after initialization and there may not be any use cases for dynamic control of VCC plane power limit values during run time. BIOS may be ideally used to read the VR (and associated heat sink) capabilities and program the PCU with the power limit information during boot. No matter what the method is, Intel recommends exclusive use of just one entity or interface, PECI for instance, to manage VCC plane power limiting needs. If PECI is being used to manage VCC plane power limiting activities, BIOS should lock out all subsequent inband VCC plane power limiting accesses by setting bit 31 of the PPO_POWER_LIMIT MSR and CSR to '1'.

The same conversion formula used for DRAM Power Limiting (see [Section 2.5.2.6.9](#)) should be applied for encoding or programming the 'Control Time Window' in bits [23:17].

Figure 2-35. Power Limit Data for VCC Power Plane



2.5.2.6.26 Package Power Limits For Multiple Turbo Modes

This feature allows the PECI host to program two power limit values to support multiple turbo modes. The operating systems and drivers can balance the power budget using these two limits. Two separate PECI requests are available to program the lower and upper 32 bits of the power limit data shown in [Figure 2-36](#). The units for the Power Limit and Control Time Window are determined as per the Package Power SKU Unit settings described in [Section 2.5.2.6.13](#) while the valid range for power limit values are determined by the Package Power SKU settings described in [Section 2.5.2.6.14](#). Setting the Clamp Mode bits is required to allow the cores to go into power states below what the operating system originally requested. The Power Limit Enable bits should be set to enable the power limiting function. Power limit values, enable and clamp mode bits can all be set in the same command cycle. All RAPL parameter values including the power limit value, control time window, clamp mode and enable bit will have to be specified correctly even if the intent is to change just one parameter value when programming over PECI.

Intel recommends exclusive use of just one entity or interface, PECI for instance, to manage all processor package power limiting and budgeting needs. If PECI is being used to manage package power limiting activities, BIOS should lock out all subsequent inband package power limiting accesses by setting bit 31 of the PACKAGE_POWER_LIMIT MSR and CSR to '1'. The 'power limit 1' is intended to limit processor power consumption to any reasonable value below TDP and defaults to TDP.

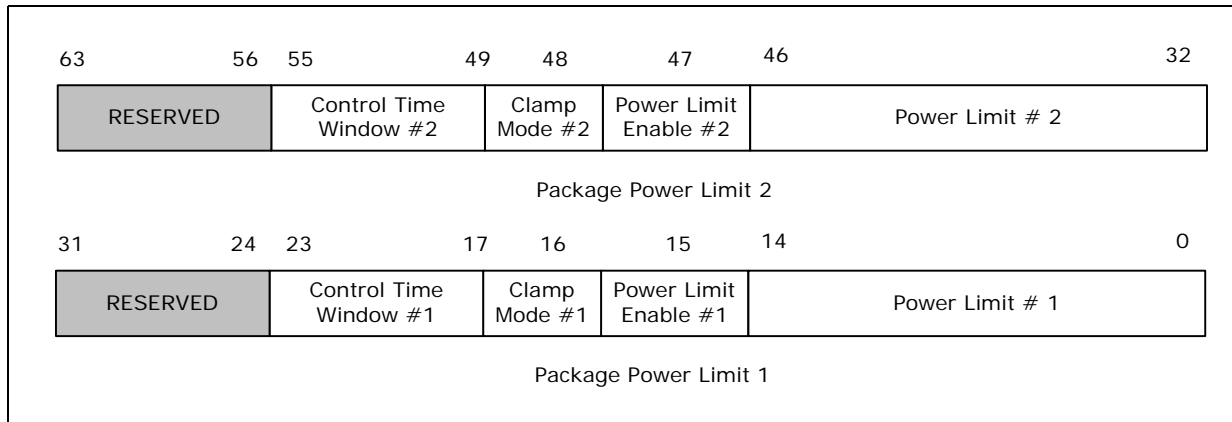


'Power Limit 1' values may be impacted by the processor heat sinks and system air flow. Processor 'power limit 2' can be used as appropriate to limit the current drawn by the processor to prevent any external power supply unit issues. The 'Power Limit 2' should always be programmed to a value (typically 20%) higher than 'Power Limit 1' and has no default value associated with it.

Though this feature is disabled by default and external programming is required to enable, initialize and control package power limit values and time windows, the processor package will still turbo to TDP if 'Power Limit 1' is not enabled or initialized. 'Control Time Window#1' (Power_Limit_1_Time also known as Tau) values may be programmed to be within a range of 250 mS-40 seconds. 'Control Time Window#2' (Power_Limit_2_Time) values should be in the range 3 mS-10 mS.

The same conversion formula used for the DRAM Power Limiting feature (see [Section 2.5.2.6.9](#)) should be applied when programming the 'Control Time Window' bits [23:17] for 'power limit 1' in [Figure 2-36](#). The 'Control Time Window' for 'power limit 2' can be directly programmed into bits [55:49] in units of mS without the aid of any conversion formulas.

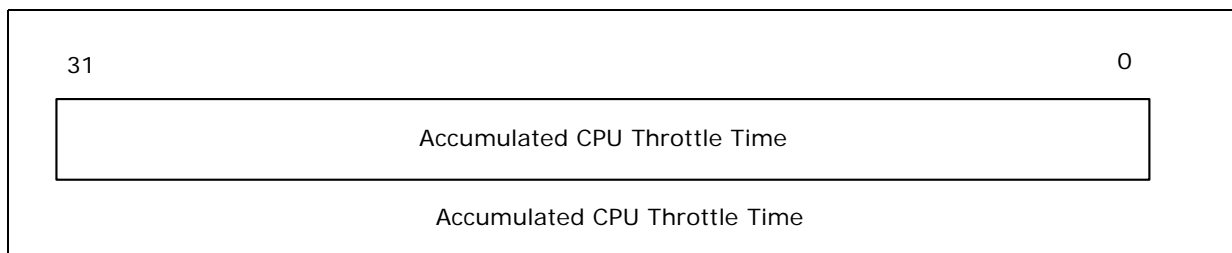
Figure 2-36. Package Turbo Power Limit Data



2.5.2.6.27 Package Power Limit Performance Status Read

This service allows the PECI host to assess the performance impact of the currently active power limiting modes. The read return data contains the total amount of time for which the entire processor package has been operating in a power state that is lower than what the operating system originally requested. This information is tracked by a 32-bit counter that wraps around. The unit for time is determined as per the Package Power SKU Unit settings described in [Section 2.5.2.6.13](#).

Figure 2-37. Package Power Limit Performance Data

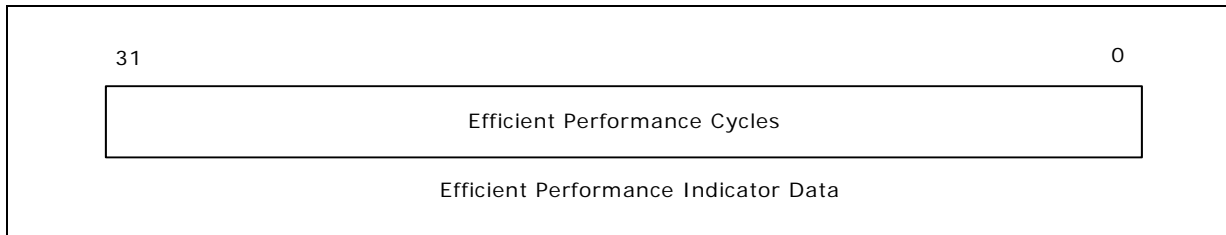




2.5.2.6.28 Efficient Performance Indicator Read

The Efficient Performance Indicator (EPI) Read provides an indication of the total number of productive cycles. Specifically, these are the cycles when the processor is engaged in any activity to retire instructions and as a result, consuming energy. Any power management entity monitoring this indicator should sample it at least once every 4 seconds to enable detection of wraparounds. Refer to the processor *Intel® 64 and IA-32 Architectures Software Developer's Manual (SDM) Volumes 1, 2, and 3*, for details on programming the Energy/Performance Bias (MSR_MISC_PWR_MGMT) register to set the 'Energy Efficiency' policy of the processor.

Figure 2-38. Efficient Performance Indicator Read



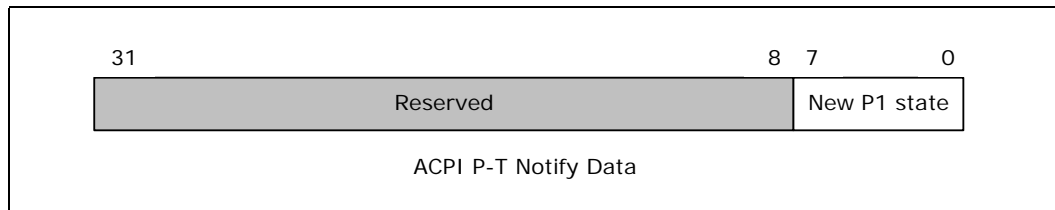
2.5.2.6.29 ACPI P-T Notify Write & Read

This feature enables the processor turbo capability when used in conjunction with the PECI package RAPL or power limit. When the BMC sets the package power limit to a value below TDP, it also determines a new corresponding turbo frequency and notifies the OS using the 'ACPI Notify' mechanism as supported by the `_PPC` or performance present capabilities object. The BMC then notifies the processor PCU using the PECI 'ACPI P-T Notify' service by programming a new state that is one p-state below the turbo frequency sent to the OS via the `_PPC` method.

When the OS requests a p-state higher than what is specified in bits [7:0] of the PECI ACPI P-T Notify data field, the CPU will treat it as request for P0 or turbo. The PCU will use the `IA32_ENERGY_PERFORMANCE_BIAS` register settings to determine the exact extent of turbo. Any OS p-state request that is equal to or below what is specified in the PECI ACPI P-T Notify will be granted as long as the RAPL power limit does not impose a lower p-state. However, turbo will not be enabled in this instance even if there is headroom between the processor energy consumption and the RAPL power limit.

This feature does not affect the Thermal Monitor behavior of the processor nor is it impacted by the setting of the power limit clamp mode bit.

Figure 2-39. ACPI P-T Notify Data





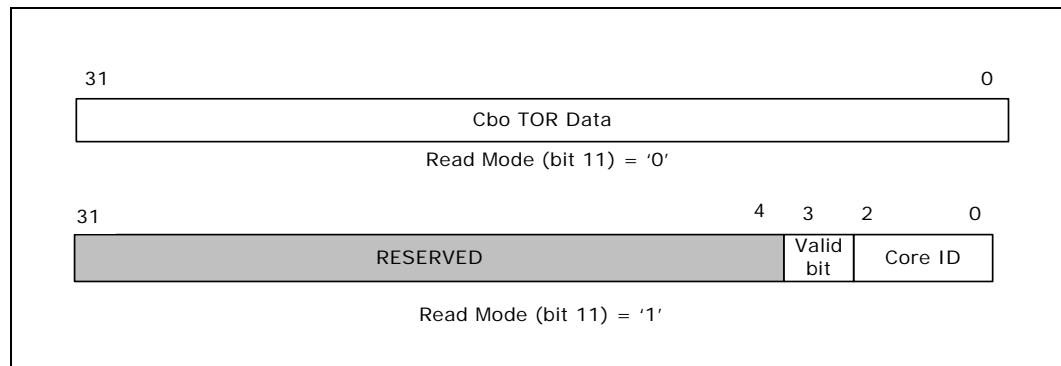
2.5.2.6.30 Caching Agent TOR Read

This feature allows the PECCI host to read the Caching Agent (Cbo) Table of Requests (TOR). This information is useful for debug in the event of a 3-strike timeout that results in a processor IERR assertion. The 16-bit parameter field is used to specify the Cbo index, TOR array index and bank number according to the following bit assignments.

- Bits [1:0] - Bank Number - legal values from 0 to 2
- Bits [6:2] - TOR Array Index - legal values from 0 to 19
- Bits [10:7] - Cbo Index - legal values from 0 to 7
- Bit [11] - Read Mode - should be set to '0' for TOR reads
- Bits [15:12] - Reserved

Bit[11] is the Read Mode bit and should be set to '0' for TOR reads. The Read Mode bit can alternatively be set to '1' to read the 'Core ID' (with associated valid bit as shown in [Figure 2-40](#)) that points to the first core that asserted the IERR. In this case bits [10:0] of the parameter field are ignored. The 'Core ID' read may not return valid data until at least 1 mS after the IERR assertion.

Figure 2-40. Caching Agent TOR Read Data

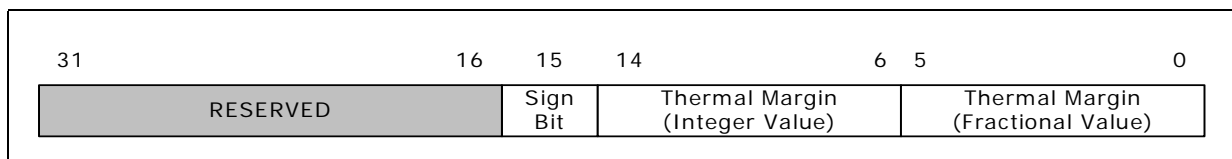


Note: Reads to caching agents that are not enabled will return all zeroes. Refer to the debug handbook for details on methods to interpret the crash dump results using the Cbo TOR data shown in [Figure 2-40](#).

2.5.2.6.31 Thermal Margin Read

This service allows the PECCI host to read the margin to the processor thermal profile or load line. Thermal margin data is returned in the format shown in [Figure 2-41](#) with a sign bit, an integer part and a fractional part. A negative thermal margin value implies that the processor is operating in violation of its thermal load line and may be indicative of a need for more aggressive cooling mechanisms through a fan speed increase or other means. This PECCI service will continue to return valid margin values even when the processor die temperature exceeds T_{jmax} .

Figure 2-41. DTS Thermal Margin Read





2.5.2.7 RdIAMSRO

The RdIAMSRO PECL command provides read access to Model Specific Registers (MSRs) defined in the processor's Intel® Architecture (IA). MSR definitions may be found in the *Intel® 64 and IA-32 Architectures Software Developer's Manual (SDM) Volumes 1, 2, and 3*. Refer to [Table 2-11](#) for the exact listing of processor registers accessible through this command.

2.5.2.7.1 Command Format

The RdIAMSRO format is as follows:

Write Length: 0x05

Read Length: 0x09 (qword)

Command: 0xb1

Description: Returns the data maintained in the processor IA MSR space as specified by the 'Processor ID' and 'MSR Address' fields. The Read Length dictates the desired data return size. This command supports only qword responses. All command responses are prepended with a completion code that contains additional pass/fail status information. Refer to [Section 2.5.5.2](#) for details regarding completion codes.

2.5.2.7.2 Processor ID Enumeration

The 'Processor ID' field that is used to address the IA MSR space refers to a specific logical processor within the CPU. The 'Processor ID' always refers to the same physical location in the processor silicon regardless of configuration as shown in the example in [Figure 2-42](#). For example, if certain logical processors are disabled by BIOS, the Processor ID mapping will not change. The total number of Processor IDs on a CPU is product-specific.

'Processor ID' enumeration involves discovering the logical processors enabled within the CPU package. This can be accomplished by reading the 'Max Thread ID' value through the RdPkgConfig() command (Index 0, Parameter 3) described in [Section 2.5.2.6.12](#) and subsequently querying each of the supported processor threads. Unavailable processor threads will return a completion code of 0x90.

Alternatively, this information may be obtained from the RESOLVED_CORES_MASK register readable through the RdPCICongigLocal() PECL command described in [Section 2.5.2.9](#) or other means. Bits [7:0] and [9:8] of this register contain the 'Core Mask' and 'Thread Mask' information respectively. The 'Thread Mask' applies to all the enabled cores within the processor package as indicated by the 'Core Mask'. For the processor PECL clients, the 'Processor ID' may take on values in the range 0 through 15.

Figure 2-42. Processor ID Construction Example

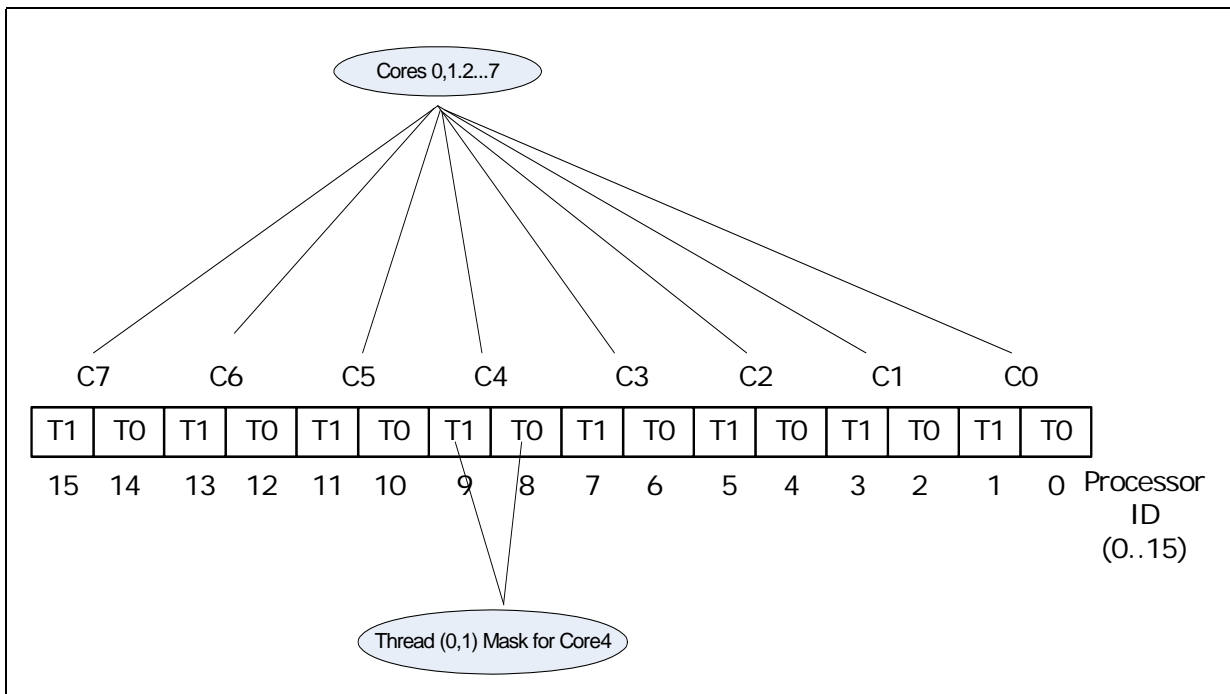
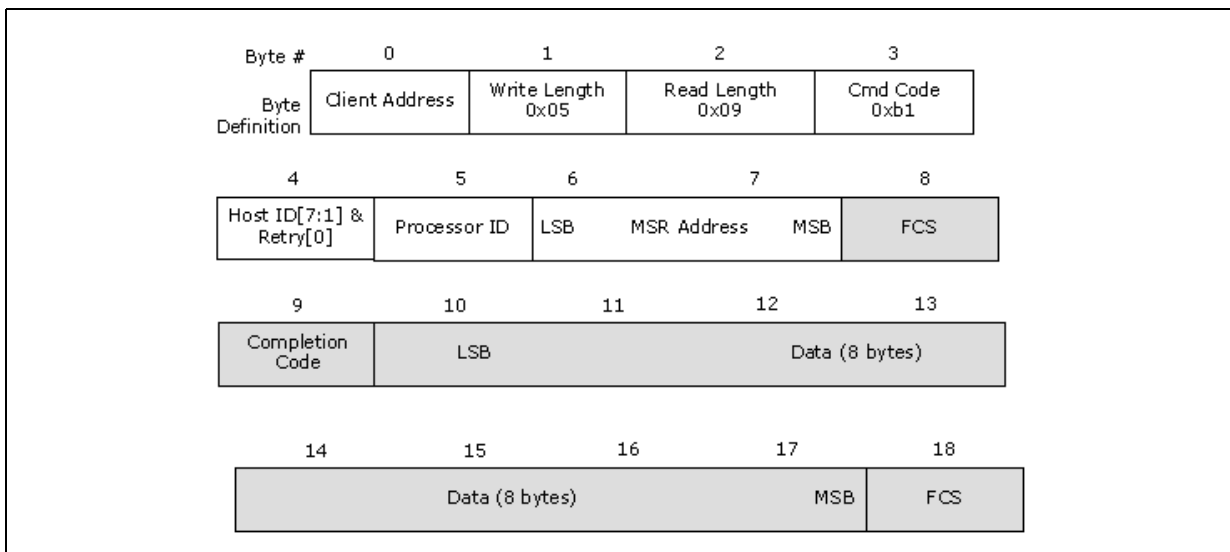


Figure 2-43. RdIAMSRO



Note: The 2-byte MSR Address field and read data field defined in Figure 2-43 are sent in standard PECL ordering with LSB first and MSB last.



2.5.2.7.3 Supported Responses

The typical client response is a passing FCS, a passing Completion Code and valid data. Under some conditions, the client's response will indicate a failure.

Table 2-10. RdIAMSRO Response Definition

Response	Meaning
Bad FCS	Electrical error
Abort FCS	Illegal command formatting (mismatched RL/WL/Command Code)
CC: 0x40	Command passed, data is valid.
CC: 0x80	Response timeout. The processor was not able to generate the required response in a timely fashion. Retry is appropriate.
CC: 0x81	Response timeout. The processor is not able to allocate resources for servicing this command at this time. Retry is appropriate.
CC: 0x82	The processor hardware resources required to service this command are in a low power state. Retry may be appropriate after modification of PECC wake mode behavior if appropriate.
CC: 0x90	Unknown/Invalid/Illegal Request
CC: 0x91	PECC control hardware, firmware or associated logic error. The processor is unable to process the request.

2.5.2.7.4 RdIAMSRO Capabilities

The processor PECC client allows PECC RdIAMSRO access to the registers listed in Table 2-11. These registers pertain to the processor core and uncore error banks (machine check banks 0 through 19). Information on the exact number of accessible banks for the processor device may be obtained by reading the IA32_MCG_CAP[7:0] MSR (0x0179). This register may be alternatively read using a RDMSR BIOS instruction. Please consult the *Intel® 64 and IA-32 Architectures Software Developer's Manual (SDM) Volumes 1, 2, and 3* for more information on the exact number of cores supported by a particular processor SKU. Any attempt to read processor MSRs that are not accessible over PECC or simply not implemented will result in a completion code of 0x90.

PECC access to these registers is expected only when in-band access mechanisms are not available.

Table 2-11. RdIAMSRO Services Summary (Sheet 1 of 2)

Process or ID (byte)	MSR Address (dword)	Meaning	Process or ID (byte)	MSR Address (dword)	Meaning	Process or ID (byte)	MSR Address (dword)	Meaning
0x0-0xF	0x0400	IA32_MC0_CTL	0x0-0xF	0x041B	IA32_MC6_MISC	0x0-0xF	0x0436	IA32_MC13_ADDR
0x0-0xF	0x0280	IA32_MC0_CTL2	0x0-0xF	0x041C	IA32_MC7_CTL	0x0-0xF	0x0437	IA32_MC13_MISC
0x0-0xF	0x0401	IA32_MC0_STATUS	0x0-0xF	0x0287	IA32_MC7_CTL2	0x0-0xF	0x0438	IA32_MC14_CTL
0x0-0xF	0x0402	IA32_MC0_ADDR	0x0-0xF	0x041D	IA32_MC7_STATUS	0x0-0xF	0x028E	IA32_MC14_CTL2
0x0-0xF	0x0403	IA32_MC0_MISC ¹	0x0-0xF	0x041E	IA32_MC7_ADDR	0x0-0xF	0x0439	IA32_MC14_STATUS
0x0-0xF	0x0404	IA32_MC1_CTL	0x0-0xF	0x041F	IA32_MC7_MISC	0x0-0xF	0x043A	IA32_MC14_ADDR
0x0-0xF	0x0281	IA32_MC1_CTL2	0x0-0xF	0x0420	IA32_MC8_CTL	0x0-0xF	0x043B	IA32_MC14_MISC
0x0-0xF	0x0405	IA32_MC1_STATUS	0x0-0xF	0x0288	IA32_MC8_CTL2	0x0-0xF	0x043C	IA32_MC15_CTL
0x0-0xF	0x0406	IA32_MC1_ADDR	0x0-0xF	0x0421	IA32_MC8_STATUS	0x0-0xF	0x028F	IA32_MC15_CTL2
0x0-0xF	0x0407	IA32_MC1_MISC	0x0-0xF	0x0422	IA32_MC8_ADDR	0x0-0xF	0x043D	IA32_MC15_STATUS
0x0-0xF	0x0408	IA32_MC2_CTL ²	0x0-0xF	0x0423	IA32_MC8_MISC	0x0-0xF	0x043E	IA32_MC15_ADDR



Table 2-11. RdIAMSRO Services Summary (Sheet 2 of 2)

Process or ID (byte)	MSR Address (dword)	Meaning	Process or ID (byte)	MSR Address (dword)	Meaning	Process or ID (byte)	MSR Address (dword)	Meaning
0x0-0xF	0x0282	IA32_MC2_CTL2	0x0-0xF	0x0424	IA32_MC9_CTL	0x0-0xF	0x043F	IA32_MC15_MISC
0x0-0xF	0x0409	IA32_MC2_STATUS	0x0-0xF	0x0289	IA32_MC9_CTL2	0x0-0xF	0x0440	IA32_MC16_CTL
0x0-0xF	0x040A	IA32_MC2_ADDR ²	0x0-0xF	0x0425	IA32_MC9_STATUS	0x0-0xF	0x0290	IA32_MC16_CTL2
0x0-0xF	0x040B	IA32_MC2_MISC ²	0x0-0xF	0x0426	IA32_MC9_ADDR	0x0-0xF	0x0441	IA32_MC16_STATUS
0x0-0xF	0x040C	IA32_MC3_CTL	0x0-0xF	0x0427	IA32_MC9_MISC	0x0-0xF	0x0442	IA32_MC16_ADDR
0x0-0xF	0x0283	IA32_MC3_CTL2	0x0-0xF	0x0428	IA32_MC10_CTL	0x0-0xF	0x0443	IA32_MC16_MISC
0x0-0xF	0x040D	IA32_MC3_STATUS	0x0-0xF	0x028A	IA32_MC10_CTL2	0x0-0xF	0x0444	IA32_MC17_CTL
0x0-0xF	0x040E	IA32_MC3_ADDR	0x0-0xF	0x0429	IA32_MC10_STATUS	0x0-0xF	0x0291	IA32_MC17_CTL2
0x0-0xF	0x040F	IA32_MC3_MISC	0x0-0xF	0x042A	IA32_MC10_ADDR	0x0-0xF	0x0445	IA32_MC17_STATUS
0x0-0xF	0x0410	IA32_MC4_CTL	0x0-0xF	0x042B	IA32_MC10_MISC	0x0-0xF	0x0446	IA32_MC17_ADDR
0x0-0xF	0x0284	IA32_MC4_CTL2	0x0-0xF	0x042C	IA32_MC11_CTL	0x0-0xF	0x0447	IA32_MC17_MISC
0x0-0xF	0x0411	IA32_MC4_STATUS	0x0-0xF	0x028B	IA32_MC11_CTL2	0x0-0xF	0x0448	IA32_MC18_CTL
0x0-0xF	0x0412	IA32_MC4_ADDR ²	0x0-0xF	0x042D	IA32_MC11_STATUS	0x0-0xF	0x0292	IA32_MC18_CTL2
0x0-0xF	0x0413	IA32_MC4_MISC ²	0x0-0xF	0x042E	IA32_MC11_ADDR	0x0-0xF	0x0449	IA32_MC18_STATUS
0x0-0xF	0x0414	IA32_MC5_CTL	0x0-0xF	0x042F	IA32_MC11_MISC	0x0-0xF	0x044A	IA32_MC18_ADDR
0x0-0xF	0x0285	IA32_MC5_CTL2	0x0-0xF	0x0430	IA32_MC12_CTL	0x0-0xF	0x044B	IA32_MC18_MISC
0x0-0xF	0x0415	IA32_MC5_STATUS	0x0-0xF	0x028C	IA32_MC12_CTL2	0x0-0xF	0x044C	IA32_MC19_CTL
0x0-0xF	0x0416	IA32_MC5_ADDR	0x0-0xF	0x0431	IA32_MC12_STATUS	0x0-0xF	0x0293	IA32_MC19_CTL2
0x0-0xF	0x0417	IA32_MC5_MISC	0x0-0xF	0x0432	IA32_MC12_ADDR	0x0-0xF	0x044D	IA32_MC19_STATUS
0x0-0xF	0x0418	IA32_MC6_CTL	0x0-0xF	0x0433	IA32_MC12_MISC	0x0-0xF	0x044E	IA32_MC19_ADDR
0x0-0xF	0x0286	IA32_MC6_CTL2	0x0-0xF	0x0434	IA32_MC13_CTL	0x0-0xF	0x0179	IA32_MCG_CAP
0x0-0xF	0x0419	IA32_MC6_STATUS	0x0-0xF	0x028D	IA32_MC13_CTL2	0x0-0xF	0x017A	IA32_MCG_STATUS
0x0-0xF	0x041A	IA32_MC6_ADDR	0x0-0xF	0x0435	IA32_MC13_STATUS	0x0-0xF	0x0178	IA32_MCG_CONTAIN

Notes:

1. The IA32_MCO_MISC register details will be available upon implementation in a future processor stepping.
2. The MCI_ADDR and MCI_MISC registers for machine check banks 2 & 4 are not implemented on the processors. The MCI_CTL register for machine check bank 2 is also not implemented.
3. The PECl host must determine the total number of machine check banks and the validity of the MCI_ADDR and MCI_MISC register contents prior to issuing a read to the machine check bank similar to standard machine check architecture enumeration and accesses.
4. The information presented in [Table 2-11](#) is applicable to the processor only. No association between bank numbers and logical functions should be assumed for any other processor devices (past, present or future) based on the information presented in [Table 2-11](#).
5. The processor machine check banks 4 through 19 reside in the processor uncore and hence will return the same value independent of the processor ID used to access these banks.
6. The IA32_MCG_STATUS, IA32_MCG_CONTAIN and IA32_MCG_CAP are located in the uncore and will return the same value independent of the processor ID used to access them.
7. The processor machine check banks 0 through 3 are core-specific. Since the processor ID is thread-specific and not core-specific, machine check banks 0 through 3 will return the same value for a particular core independent of the thread referenced by the processor ID.
8. PECl accesses to the machine check banks may not be possible in the event of a core hang. A warm reset of the processor may be required to read any sticky machine check banks.
9. Valid processor ID values may be obtained by using the enumeration methods described in [Section 2.5.2.7.2](#).
10. Reads to a machine check bank within a core or thread that is disabled will return all zeroes with a completion code of 0x90.
11. For SKUs where Intel QPI is disabled or absent, reads to the corresponding machine check banks will return all zeros with a completion code of 0x40.

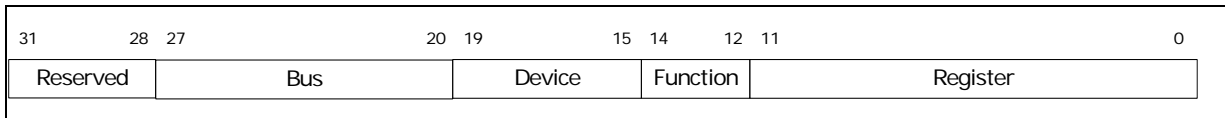


2.5.2.8 RdPCISConfig()

The RdPCISConfig() command provides sideband read access to the PCI configuration space maintained in downstream devices external to the processor. PECS originators may conduct a device/function/register enumeration sweep of this space by issuing reads in the same manner that the BIOS would. A response of all 1's may indicate that the device/function/register is unimplemented even with a 'passing' completion code. Alternatively, reads to unimplemented registers may return a completion code of 0x90 indicating an invalid request. Responses will follow normal PCI protocol.

PCI configuration addresses are constructed as shown in Figure 2-44. Under normal in-band procedures, the Bus number would be used to direct a read or write to the proper device. Actual PCI bus numbers for all PCI devices including the PCH are programmable by BIOS. The bus number for PCH devices may be obtained by reading the CPUBUSNO CSR. Refer to the *Intel® Xeon® Processor E5 Product Family Datasheet Volume Two* document for details on this register.

Figure 2-44. PCI Configuration Address



PCI configuration reads may be issued in byte, word or dword granularities.

2.5.2.8.1 Command Format

The RdPCISConfig() format is as follows:

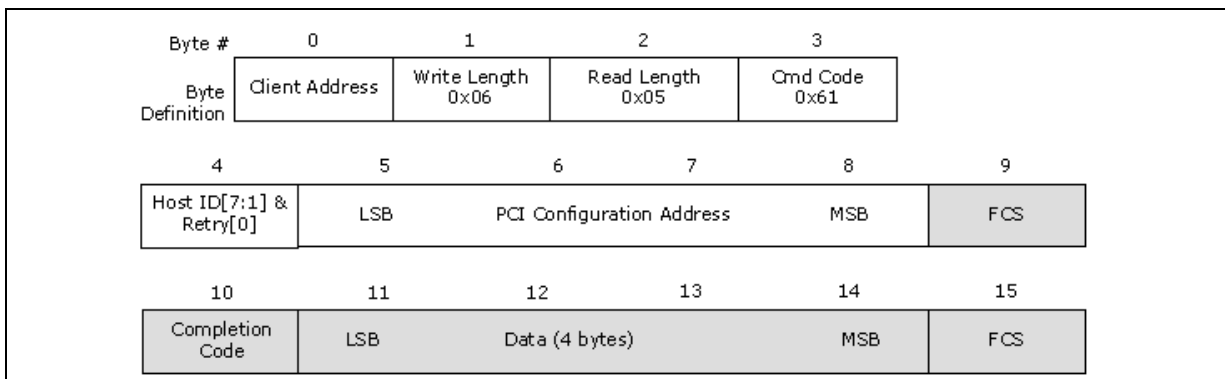
Write Length: 0x06

Read Length: 0x05 (dword)

Command: 0x61

Description: Returns the data maintained in the PCI configuration space at the requested PCI configuration address. The Read Length dictates the desired data return size. This command supports only dword responses with a completion code on the processor PECS clients. All command responses are prepended with a completion code that includes additional pass/fail status information. Refer to Section 2.5.5.2 for details regarding completion codes.

Figure 2-45. RdPCISConfig()



Note: The 4-byte PCI configuration address and read data field defined in Figure 2-45 are sent in standard PECS ordering with LSB first and MSB last.



2.5.2.8.2 Supported Responses

The typical client response is a passing FCS, a passing Completion Code and valid data. Under some conditions, the client's response will indicate a failure.

The PECE client response can also vary depending on the address and data. It will respond with a passing completion code if it successfully submits the request to the appropriate location and gets a response.

Table 2-12. RdPCIConfig() Response Definition

Response	Meaning
Bad FCS	Electrical error
Abort FCS	Illegal command formatting (mismatched RL/WL/Command Code)
CC: 0x40	Command passed, data is valid.
CC: 0x80	Response timeout. The processor was not able to generate the required response in a timely fashion. Retry is appropriate.
CC: 0x81	Response timeout. The processor is not able to allocate resources for servicing this command at this time. Retry is appropriate.
CC: 0x82	The processor hardware resources required to service this command are in a low power state. Retry may be appropriate after modification of PECE wake mode behavior if appropriate.
CC: 0x90	Unknown/Invalid/Illegal Request
CC: 0x91	PECE control hardware, firmware or associated logic error. The processor is unable to process the request.

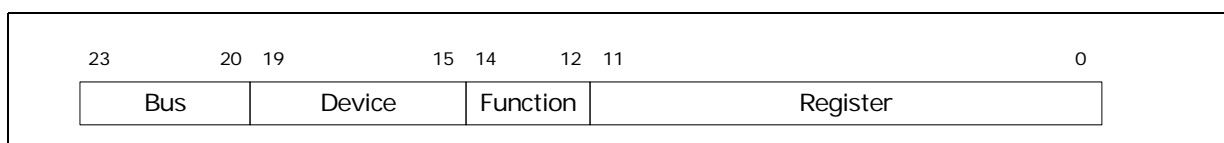
2.5.2.9 RdPCIConfigLocal()

The RdPCIConfigLocal() command provides sideband read access to the PCI configuration space that resides within the processor. This includes all processor IIO and uncore registers within the PCI configuration space as described in the *Intel® Xeon® Processor E5 Product Family Datasheet Volume Two* document.

PECE originators may conduct a device/function enumeration sweep of this space by issuing reads in the same manner that the BIOS would. A response of all 1's may indicate that the device/function/register is unimplemented even with a 'passing' completion code. Alternatively, reads to unimplemented or hidden registers may return a completion code of 0x90 indicating an invalid request. It is also possible that reads to function 0 of non-existent IIO devices issued prior to BIOS POST may return all '0's with a passing completion code. PECE originators can access this space even prior to BIOS enumeration of the system buses. There is no read restriction on accesses to locked registers.

PCI configuration addresses are constructed as shown in [Figure 2-46](#). Under normal in-band procedures, the Bus number would be used to direct a read or write to the proper device. PECE reads to the processor IIO devices should specify a bus number of '0000' and reads to the rest of the processor uncore should specify a bus number of '0001' for bits [23:20] in [Figure 2-46](#). Any request made with a bad Bus number is ignored and the client will respond with all '0's and a 'passing' completion code.

Figure 2-46. PCI Configuration Address for local accesses





2.5.2.9.1 Command Format

The RdPCIConfigLocal() format is as follows:

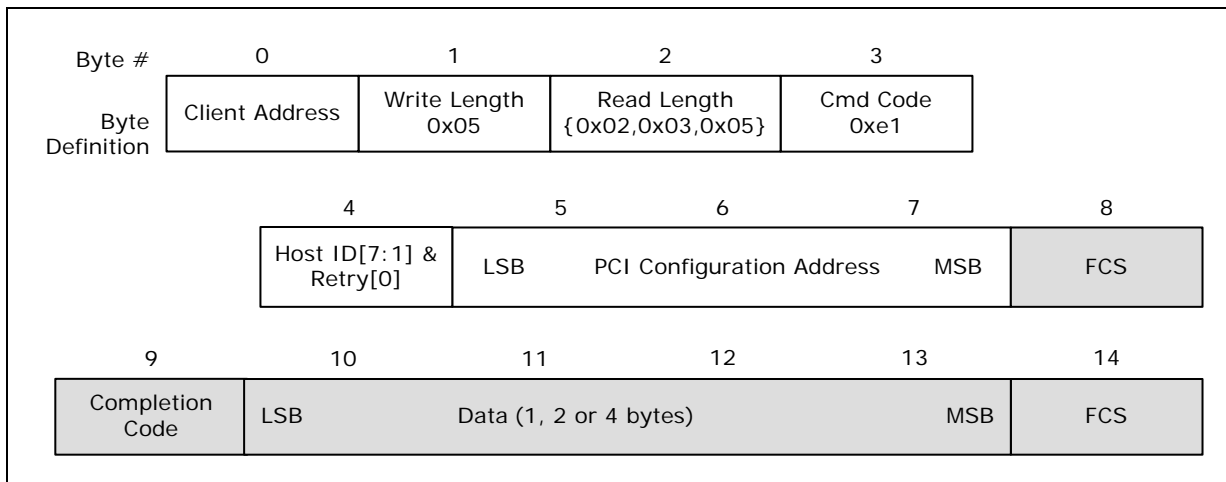
Write Length: 0x05

Read Length: 0x02 (byte), 0x03 (word), 0x05 (dword)

Command: 0xe1

Description: Returns the data maintained in the PCI configuration space within the processor at the requested PCI configuration address. The Read Length dictates the desired data return size. This command supports byte, word and dword responses as well as a completion code. All command responses are prepended with a completion code that includes additional pass/fail status information. Refer to [Section 2.5.5.2](#) for details regarding completion codes.

Figure 2-47. RdPCIConfigLocal()



Note: The 3-byte PCI configuration address and read data field defined in [Figure 2-47](#) are sent in standard PECL ordering with LSB first and MSB last.

2.5.2.9.2 Supported Responses

The typical client response is a passing FCS, a passing Completion Code and valid data. Under some conditions, the client's response will indicate a failure.

The PECL client response can also vary depending on the address and data. It will respond with a passing completion code if it successfully submits the request to the appropriate location and gets a response.

Table 2-13. RdPCIConfigLocal() Response Definition (Sheet 1 of 2)

Response	Meaning
Bad FCS	Electrical error
Abort FCS	Illegal command formatting (mismatched RL/WL/Command Code)
CC: 0x40	Command passed, data is valid.
CC: 0x80	Response timeout. The processor was not able to generate the required response in a timely fashion. Retry is appropriate.
CC: 0x81	Response timeout. The processor is not able to allocate resources for servicing this command at this time. Retry is appropriate.



Table 2-13. RdPCIConfigLocal() Response Definition (Sheet 2 of 2)

Response	Meaning
CC: 0x82	The processor hardware resources required to service this command are in a low power state. Retry may be appropriate after modification of PECl wake mode behavior if appropriate.
CC: 0x90	Unknown/Invalid/Illegal Request
CC: 0x91	PECl control hardware, firmware or associated logic error. The processor is unable to process the request.

2.5.2.10 WrPCIConfigLocal()

The WrPCIConfigLocal() command provides sideband write access to the PCI configuration space that resides within the processor. PECl originators can access this space even before BIOS enumeration of the system buses. The exact listing of supported devices and functions for writes using this command on the processor is defined in Table 2-19. The write accesses to registers that are locked will not take effect but will still return a completion code of 0x40. However, write accesses to registers that are hidden will return a completion code of 0x90.

Because a WrPCIConfigLocal() command results in an update to potentially critical registers inside the processor, it includes an Assured Write FCS (AW FCS) byte as part of the write data payload. In the event that the AW FCS mismatches with the client-calculated FCS, the client will abort the write and will always respond with a bad write FCS.

PCI Configuration addresses are constructed as shown in Figure 2-46. The write command is subject to the same address configuration rules as defined in Section 2.5.2.9. PCI configuration writes may be issued in byte, word or dword granularity.

2.5.2.10.1 Command Format

The WrPCIConfigLocal() format is as follows:

Write Length: 0x07 (byte), 0x08 (word), 0x0a (dword)

Read Length: 0x01

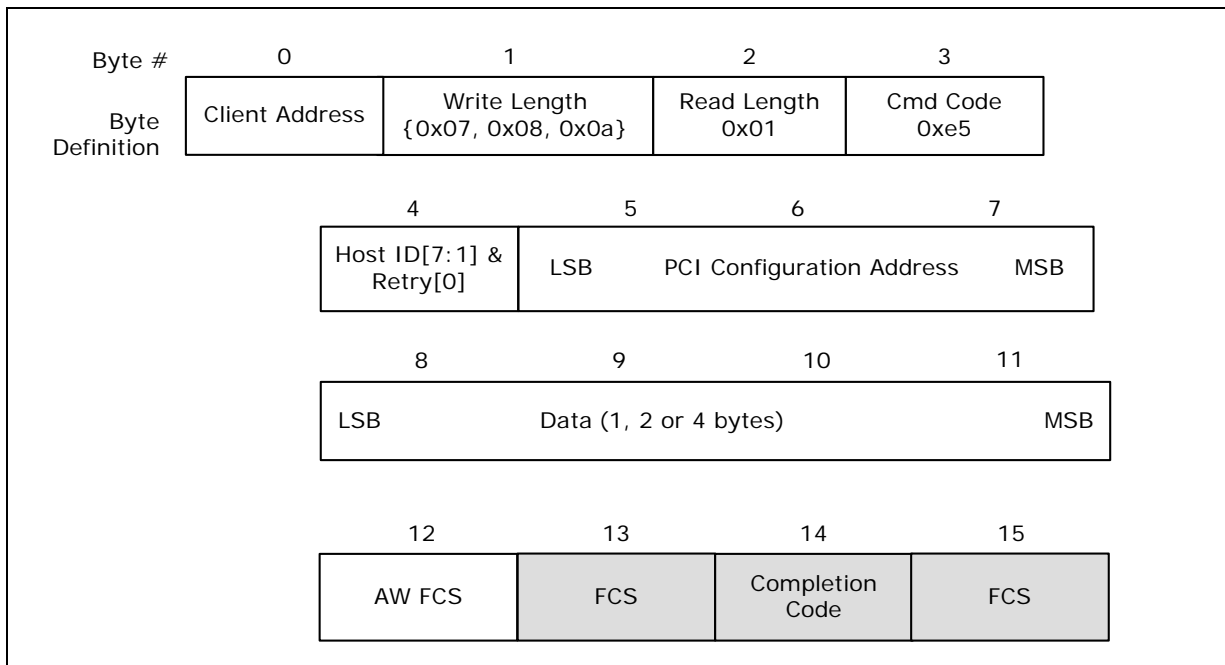
Command: 0xe5

AW FCS Support: Yes

Description: Writes the data sent to the requested register address. Write Length dictates the desired write granularity. The command always returns a completion code indicating pass/fail status. Refer to Section 2.5.5.2 for details on completion codes.



Figure 2-48. WrPCIConfigLocal()



Note: The 3-byte PCI configuration address and write data field defined in Figure 2-48 are sent in standard PECl ordering with LSB first and MSB last.

2.5.2.10.2 Supported Responses

The typical client response is a passing FCS, a passing Completion Code and valid data. Under some conditions, the client's response will indicate a failure.

The PECl client response can also vary depending on the address and data. It will respond with a passing completion code if it successfully submits the request to the appropriate location and gets a response.

Table 2-14. WrPCIConfigLocal() Response Definition

Response	Meaning
Bad FCS	Electrical error or AW FCS failure
Abort FCS	Illegal command formatting (mismatched RL/WL/Command Code)
CC: 0x40	Command passed, data is valid.
CC: 0x80	Response timeout. The processor was not able to generate the required response in a timely fashion. Retry is appropriate.
CC: 0x81	Response timeout. The processor is not able to allocate resources for servicing this command at this time. Retry is appropriate.
CC: 0x82	The processor hardware resources required to service this command are in a low power state. Retry may be appropriate after modification of PECl wake mode behavior if appropriate.
CC: 0x90	Unknown/Invalid/Illegal Request
CC: 0x91	PECl control hardware, firmware or associated logic error. The processor is unable to process the request.



2.5.2.10.3 WrPCISConfigLocal() Capabilities

On the processor PECI clients, the PECI WrPCISConfigLocal() command provides a method for programming certain integrated memory controller and IIO functions as described in Table 2-15. Refer to the *Intel® Xeon® Processor E5 Product Family Datasheet Volume Two* for more details on specific register definitions. It also enables writing to processor REUT (Robust Electrical Unified Test) registers associated with the Intel QPI, PCIe* and DDR3 functions.

Table 2-15. WrPCISConfigLocal() Memory Controller and IIO Device/Function Support

Bus	Device	Function	Offset Range	Description
0000	0-5	0-7	000-FFFh	Integrated I/O (IIO) Configuration Registers
0001	15	0	104h-127h	Integrated Memory Controller MemHot Registers
0001	15	0	180h-1AFh	Integrated Memory Controller SMBus Registers
0001	15	1	080h-0CFh	Integrated Memory Controller RAS Registers (Scrub/Spare)
0001	16	0, 1, 4, 5	104h-18Bh 1F4h-1FFh	Integrated Memory Controller Thermal Control Registers
0001	16	2, 3, 6, 7	104h-147h	Integrated Memory Controller Error Registers

2.5.3 Client Management

2.5.3.1 Power-up Sequencing

The PECI client will not be available when the PWRGOOD signal is de-asserted. Any transactions on the bus during this time will be completely ignored, and the host will read the response from the client as all zeroes. PECI client initialization is completed approximately 100 μS after the PWRGOOD assertion. This is represented by the start of the PECI Client “Data Not Ready” (DNR) phase in Figure 2-49. While in this phase, the PECI client will respond normally to the Ping() and GetDIB() commands and return the highest processor die temperature of 0x0000 to the GetTemp() command. All other commands will get a ‘Response Timeout’ completion in the DNR phase as shown in Table 2-16. All PECI services with the exception of core MSR space accesses become available ~500 μS after RESET_N de-assertion as shown in Figure 2-49. PECI will be fully functional with all services including core accesses being available when the core comes out of reset upon completion of the RESET microcode execution.

In the event of the occurrence of a fatal or catastrophic error, all PECI services with the exception of core MSR space accesses will be available during the DNR phase to facilitate debug through configuration space accesses.

Table 2-16. PECI Client Response During Power-Up (Sheet 1 of 2)

Command	Response During ‘Data Not Ready’	Response During ‘Available Except Core Services’
Ping()	Fully functional	Fully functional
GetDIB()	Fully functional	Fully functional
GetTemp()	Client responds with a ‘hot’ reading or 0x0000	Fully functional
RdPkgConfig()	Client responds with a timeout completion code of 0x81	Fully functional
WrPkgConfig()	Client responds with a timeout completion code of 0x81	Fully functional
RdIAMSRR()	Client responds with a timeout completion code of 0x81	Client responds with a timeout completion code of 0x81

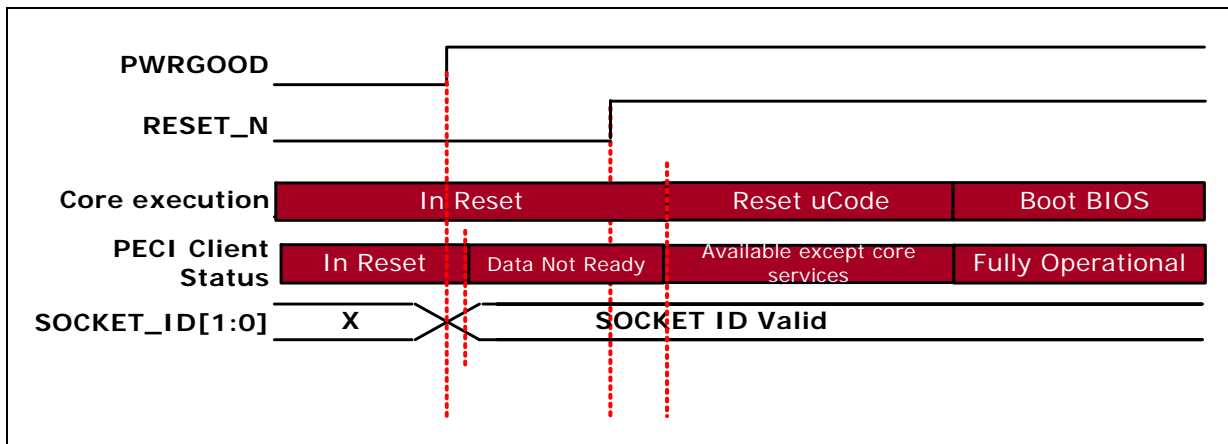


Table 2-16. PECE Client Response During Power-Up (Sheet 2 of 2)

Command	Response During 'Data Not Ready'	Response During 'Available Except Core Services'
RdPCIFConfigLocal()	Client responds with a timeout completion code of 0x81	Fully functional
WrPCIFConfigLocal()	Client responds with a timeout completion code of 0x81	Fully functional
RdPCIFConfig()	Client responds with a timeout completion code of 0x81	Fully functional

In the event that the processor is tri-stated using power-on-configuration controls, the PECE client will also be tri-stated. Processor tri-state controls are described in Section 7.3, "Power-On Configuration (POC) Options".

Figure 2-49. The Processor PECE Power-up Timeline()



2.5.3.2 Device Discovery

The PECE client is available on all processors. The presence of a PECE enabled processor in a CPU socket can be confirmed by using the Ping() command described in Section 2.5.2.1. Positive identification of the PECE revision number can be achieved by issuing the GetDIB() command. The revision number acts as a reference to the PECE specification document applicable to the processor client definition. Please refer to Section 2.5.2.2 for details on GetDIB response formatting.

2.5.3.3 Client Addressing

The PECE client assumes a default address of 0x30. The PECE client address for the processor is configured through the settings of the SOCKET_ID[1:0] signals. Each processor socket in the system requires that the two SOCKET_ID signals be configured to a different PECE addresses. Strapping the SOCKET_ID[1:0] pins results in the client addresses shown in Table 2-17. These package strap(s) are evaluated at the assertion of PWRGOOD (as depicted in Figure 2-49). Refer to the appropriate Platform Design Guide (PDG) for recommended resistor values for establishing non-default SOCKET_ID settings.



The client address may not be changed after PWRGOOD assertion, until the next power cycle on the processor. Removal of a processor from its socket or tri-stating a processor will have no impact to the remaining non-tri-stated PECI client addresses. Since each socket in the system should have a unique PECI address, the SOCKET_ID strapping is required to be unique for each socket.

Table 2-17. SOCKET ID Strapping

SOCKET_ID[1] Strap	SOCKET_ID[0] Strap	PECI Client Address
Ground	Ground	0x30
Ground	V _{TT}	0x31
V _{TT}	Ground	0x32
V _{TT}	V _{TT}	0x33

2.5.3.4 C-states

The processor PECI client may be fully functional in most core and package C-states.

- The Ping(), GetDIB(), GetTemp(), RdPkgConfig() and WrPkgConfig() commands have no measurable impact on CPU power in any of the core or package C-states.
- The RdIAMS() command will complete normally unless the targeted core is in a C-state that is C3 or deeper. The PECI client will respond with a completion code of 0x82 (see Table 2-22 for definition) for RdIAMS() accesses in core C-states that are C3 or deeper.
- The RdPCIConfigLocal(), WrPCIConfigLocal(), and RdPCIConfig() commands will not impact the core C-states but may have a measurable impact on the package C-state. The PECI client will successfully return data without impacting package C-state if the resources needed to service the command are not in a low power state.
 - If the resources required to service the command are in a low power state, the PECI client will respond with a completion code of 0x82 (see Table 2-22 for definition). If this is the case, setting the “Wake on PECI” mode bit as described in Section 2.5.2.6 can cause a package ‘pop-up’ to the C2 state and enable successful completion of the command. The exact power impact of a pop-up to C2 will vary by product SKU, the C-state from which the pop-up is initiated and the negotiated PECI bit rate.

Table 2-18. Power Impact of PECI Commands vs. C-states

Command	Power Impact
Ping()	Not measurable
GetDIB()	Not measurable
GetTemp()	Not measurable
RdPkgConfig()	Not measurable
WrPkgConfig()	Not measurable
RdIAMS()	Not measurable. PECI client will not return valid data in core C-state that is C3 or deeper
RdPCIConfigLocal()	May require package ‘pop-up’ to C2 state
WrPCIConfigLocal()	May require package ‘pop-up’ to C2 state
RdPCIConfig()	May require package ‘pop-up’ to C2 state



2.5.3.5 S-states

The processor PECI client is always guaranteed to be operational in the S0 sleep state.

- The Ping(), GetDIB(), GetTemp(), RdPkgConfig(), WrPkgConfig(), RdPCIConfigLocal() and WrPCIConfigLocal() will be fully operational in S0 and S1. Responses in S3 or deeper states are dependent on POWERGOOD assertion status.
- The RdPCIConfig() and RdIAMS() responses are guaranteed in S0 only. Behavior in S1 or deeper states is indeterminate.
- PECI behavior is indeterminate in the S3, S4 and S5 states and responses to PECI originator requests when the PECI client is in these states cannot be guaranteed.

2.5.3.6 Processor Reset

The processor PECI client is fully reset on all RESET_N assertions. Upon deassertion of RESET_N where power is maintained to the processor (otherwise known as a 'warm reset'), the following are true:

- The PECI client assumes a bus Idle state.
- The Thermal Filtering Constant is retained.
- PECI SOCKET_ID is retained.
- GetTemp() reading resets to 0x0000.
- Any transaction in progress is aborted by the client (as measured by the client no longer participating in the response).
- The processor client is otherwise reset to a default configuration.

The assertion of the CPU_ONLY_RESET signal does not reset the processor PECI client. As such, it will have no impact on the basic PECI commands, namely the Ping(), GetTemp() and GetDIB(). However, it is likely that other PECI commands that utilize processor resources being reset will receive a 'resource unavailable' response till the reset sequence is completed.

2.5.3.7 System Service Processor (SSP) Mode Support

Sockets in SSP mode have limited PECI command support. Only the following PECI commands will be supported while in SSP mode. Other PECI commands are not guaranteed to complete in this mode.

- Ping
- RdPCIConfigLocal
- WrPCIConfigLocal (all uncore and IIO CSRs within the processor PCI configuration space will be accessible)
- RdPkgConfig (Index 0 only)

Sockets remain in SSP mode until the "Go" handshake is received. This is applicable to the following SSP modes.

2.5.3.7.1 BMC INIT Mode

The BMC INIT boot mode is used to provide a quick and efficient means to transfer responsibility for uncore configuration to a service processor like the BMC. In this mode, the socket performs a minimal amount of internal configuration and then waits for the BMC or service processor to complete the initialization.



2.5.3.7.2 Link Init Mode

In cases where the socket is not one Intel QPI hop away from the Firmware Agent socket, or a working link to the Firmware Agent socket cannot be resolved, the socket is placed in Link Init mode. The socket performs a minimal amount of internal configuration and waits for complete configuration by BIOS.

2.5.3.8 Processor Error Handling

Availability of PECEI services may be affected by the processor PECEI client error status. Server manageability requirements place a strong emphasis on continued availability of PECEI services to facilitate logging and debug of the error condition.

- Most processor PECEI client services are available in the event of a CAT_ERR_N assertion though they cannot be guaranteed.
- The Ping(), GetDIB(), GetTemp(), RdPkgConfig() and WrPkgConfig() commands will be serviced if the source of the CAT_ERR_N assertion is not in the processor power control unit hardware, firmware or associated register logic. Additionally, the RdPCICongigLocal() and WrPCICongigLocal() commands may also be serviced in this case.
- It is recommended that the PECEI originator read Index 0/Parameter 5 using the RdPkgConfig() command to debug the CAT_ERR_N assertion.
 - The PECEI client will return the 0x91 completion code if the CAT_ERR_N assertion is caused by the PCU hardware, firmware or associated logic errors. In such an event, only the Ping(), GetTemp() and GetDIB() PECEI commands may be serviced. All other processor PECEI services will be unavailable and further debug of the processor error status will not be possible.
 - If the PECEI client returns a passing completion code, the originator should use the response data to determine the cause of the CAT_ERR_N assertion. In such an event, it is also recommended that the PECEI originator determine the exact suite of available PECEI client services by issuing each of the PECEI commands. The processor will issue 'timeout' responses for those services that may not be available.
 - If the PECEI client continues to return the 0x81 completion code in response to multiple retries of the RdPkgConfig() command, no PECEI services, with the exception of the Ping(), GetTemp() and GetDIB(), will be guaranteed.
- The RdIAMSRR() command may be serviced during a CAT_ERR_N assertion though it cannot be guaranteed.

2.5.3.9 Originator Retry and Timeout Policy

The PECEI originator may need to retry a command if the processor PECEI client responds with a 'response timeout' completion code or a bad Read FCS. In each instance, the processor PECEI client may have started the operation but not completed it yet. When the 'retry' bit is set, the PECEI client will ignore a new request if it exactly matches a previous valid request.

The processor PECEI client will not clear the semaphore that was acquired to service the request until the originator sends the 'retry' request in a timely fashion to successfully retrieve the response data. In the absence of any automatic timeouts, this could tie up shared resources and result in artificial bandwidth conflicts.



2.5.3.10 Enumerating PECE Client Capabilities

The PECE host originator should be designed to support all optional but desirable features from all processors of interest. Each feature has a discovery method and response code that indicates availability on the destination PECE client.

The first step in the enumeration process would be for the PECE host to confirm the Revision Number through the use of the GetDIB() command. The revision number returned by the PECE client processor always maps to the revision number of the PECE specification that it is designed to. The Minor Revision Number as described in [Table 2-2](#) may be used to identify the subset of PECE commands that the processor in question supports for any major PECE revision.

The next step in the enumeration process is to utilize the desired command suite in a real execution context. If the Write FCS response is an Abort FCS or if the data returned includes an "Unknown/Invalid/Illegal Request" completion code (0x90), then the command is unsupported.

Enumerating known commands without real, execution context data, or attempting undefined commands, is dangerous because a write command could result in unexpected behavior if the data is not properly formatted. Methods for enumerating write commands using carefully constructed and innocuous data are possible, but are not guaranteed by the PECE client definition.

This enumeration procedure is not robust enough to detect differences in bit definitions or data interpretation in the message payload or client response. Instead, it is only designed to enumerate discrete features.

2.5.4 Multi-Domain Commands

The processor does not support multiple domains, but it is possible that future products will, and the following tables are included as a reference for domain-specific definitions.

Table 2-19. Domain ID Definition

Domain ID	Domain Number
0b01	0
0b10	1

Table 2-20. Multi-Domain Command Code Reference

Command Name	Domain 0 Code	Domain 1 Code
GetTemp()	0x01	0x02
RdPkgConfig()	0xa1	0xa2
WrPkgConfig()	0xa5	0xa6
RdIAMS()	0xb1	0xb2
RdPCIConfig()	0x61	0x62
RdPCIConfigLocal()	0xe1	0xe2
WrPCIConfigLocal()	0xe5	0xe6



2.5.5 Client Responses

2.5.5.1 Abort FCS

The Client responds with an Abort FCS under the following conditions:

- The decoded command is not understood or not supported on this processor (this includes good command codes with bad Read Length or Write Length bytes).
- Assured Write FCS (AW FCS) failure. Under most circumstances, an Assured Write failure will appear as a bad FCS. However, when an originator issues a poorly formatted command with a miscalculated AW FCS, the client will intentionally abort the FCS in order to guarantee originator notification.

2.5.5.2 Completion Codes

Some PECC commands respond with a completion code byte. These codes are designed to communicate the pass/fail status of the command and may also provide more detailed information regarding the class of pass or fail. For all commands listed in [Section 2.5.2](#) that support completion codes, the definition in the following table applies. Throughout this document, a completion code reference may be abbreviated with 'CC'.

An originator that is decoding these commands can apply a simple mask as shown in [Table 2-21](#) to determine a pass or fail. Bit 7 is always set on a command that did not complete successfully and is cleared on a passing command.

Table 2-21. Completion Code Pass/Fail Mask

0xxx xxxxb	Command passed
1xxx xxxxb	Command failed

Table 2-22. Device Specific Completion Code (CC) Definition

Completion Code	Description
0x40	Command Passed
CC: 0x80	Response timeout. The processor was not able to generate the required response in a timely fashion. Retry is appropriate.
CC: 0x81	Response timeout. The processor was not able to allocate resources for servicing this command. Retry is appropriate.
CC: 0x82	The processor hardware resources required to service this command are in a low power state. Retry may be appropriate after modification of PECC wake mode behavior if appropriate.
CC: 0x83-8F	Reserved
CC: 0x90	Unknown/Invalid/Illegal Request
CC: 0x91	PECC control hardware, firmware or associated logic error. The processor is unable to process the request.
CC: 0x92-9F	Reserved

Note: The codes explicitly defined in [Table 2-22](#) may be useful in PECC originator response algorithms. Reserved or undefined codes may also be generated by a PECC client device, and the originating agent must be capable of tolerating any code. The Pass/Fail mask defined in [Table 2-21](#) applies to all codes, and general response policies may be based on this information. Refer to [Section 2.5.6](#) for originator response policies and recommendations.



2.5.6 Originator Responses

The simplest policy that an originator may employ in response to receipt of a failing completion code is to retry the request. However, certain completion codes or FCS responses are indicative of an error in command encoding and a retry will not result in a different response from the client. Furthermore, the message originator must have a response policy in the event of successive failure responses. Refer to [Table 2-22](#) for originator response guidelines.

Refer to the definition of each command in [Section 2.5.2](#) for a specific definition of possible command codes or FCS responses for a given command. The following response policy definition is generic, and more advanced response policies may be employed at the discretion of the originator developer.

Table 2-23. Originator Response Guidelines

Response	After 1 Attempt	After 3 Attempts
Bad FCS	Retry	Fail with PECL client device error.
Abort FCS	Retry	Fail with PECL client device error if command was not illegal or malformed.
CC: 0x8x	Retry	The PECL client has failed in its attempts to generate a response. Notify application layer.
CC: 0x9x	Abandon any further attempts and notify application layer	N/A
None (all 0's)	Force bus idle (drive low) for 1 mS and retry	Fail with PECL client device error. Client may not be alive or may be otherwise unresponsive (for example, it could be in RESET).
CC: 0x4x	Pass	N/A
Good FCS	Pass	N/A

2.5.7 DTS Temperature Data

2.5.7.1 Format

The temperature is formatted in a 16-bit, 2's complement value representing a number of 1/64 degrees centigrade. This format allows temperatures in a range of $\pm 512^{\circ}\text{C}$ to be reported to approximately a 0.016°C resolution.

Figure 2-50. Temperature Sensor Data Format

MSB Upper nibble				MSB Lower nibble				LSB Upper nibble				LSB Lower nibble				
S	x	x	x	x	x	x	x	x	x	x	x	x	x	x	x	x
Sign	Integer Value (0-511)								Fractional Value (~0.016)							

2.5.7.2 Interpretation

The resolution of the processor's Digital Thermal Sensor (DTS) is approximately 1°C , which can be confirmed by a RDMSR from the IA32_THERM_STATUS MSR where it is architecturally defined. The MSR read will return only bits [13:6] of the PECL temperature sensor data defined in [Figure 2-50](#). PECL temperatures are sent through a configurable low-pass filter prior to delivery in the GetTemp() response data. The output of this filter produces temperatures at the full $1/64^{\circ}\text{C}$ resolution even though the DTS itself is not this accurate.



Temperature readings from the processor are always negative in a 2's complement format, and imply an offset from the processor T_{jmax} (PECI = 0). For example, if the processor T_{jmax} is 100°C, a PECI thermal reading of -10 implies that the processor is running at approximately 10°C below T_{jmax} or at 90°C. PECI temperature readings are not reliable at temperatures above T_{jmax} since the processor is outside its operating range and hence, PECI temperature readings are never positive.

The changes in PECI data counts are approximately linear in relation to changes in temperature in degrees centigrade. A change of '1' in the PECI count represents roughly a temperature change of 1 degree centigrade. This linearity is approximate and cannot be guaranteed over the entire range of PECI temperatures, especially as the offset from the maximum PECI temperature (zero) increases.

2.5.7.3 Temperature Filtering

The processor digital thermal sensor (DTS) provides an improved capability to monitor device hot spots, which inherently leads to more varying temperature readings over short time intervals. Coupled with the fact that typical fan speed controllers may only read temperatures at 4Hz, it is necessary for the thermal readings to reflect thermal trends and not instantaneous readings. Therefore, PECI supports a configurable low-pass temperature filtering function that is expressed by the equation:

$$T_N = (1-\alpha) * T_{N-1} + \alpha * T_{SAMPLE}$$

where T_N and T_{N-1} are the current and previous averaged PECI temperature values respectively, T_{SAMPLE} is the current PECI temperature sample value and the variable ' α ' = $1/2^X$, where 'X' is the 'Thermal Averaging Constant' that is programmable as described in [Section 2.5.2.6.21](#).

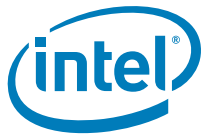
2.5.7.4 Reserved Values

Several values well out of the operational range are reserved to signal temperature sensor errors. These are summarized in [Table 2-24](#).

Table 2-24. Error Codes and Descriptions

Error Code	Description
0x8000	General Sensor Error (GSE)
0x8001	Reserved
0x8002	Sensor is operational, but has detected a temperature below its operational range (underflow)
0x8003-0x81ff	Reserved

S





3 Technologies

3.1 Intel® Virtualization Technology (Intel® VT)

Intel® Virtualization Technology (Intel® VT) makes a single system appear as multiple independent systems to software. This allows multiple, independent operating systems to run simultaneously on a single system. Intel VT comprises technology components to support virtualization of platforms based on Intel architecture microprocessors and chipsets.

- **Intel® Virtualization Technology (Intel® VT) for Intel® 64 and IA-32 Intel® Architecture (Intel® VT-x)** adds hardware support in the processor to improve the virtualization performance and robustness. Intel VT-x specifications and functional descriptions are included in the *Intel® 64 and IA-32 Architectures Software Developer's Manual, Volume 3B* and is available at <http://www.intel.com/products/processor/manuals/index.htm>
- **Intel® Virtualization Technology (Intel® VT) for Directed I/O (Intel® VT-d)** adds processor and uncore implementations to support and improve I/O virtualization performance and robustness. The Intel VT-d spec and other Intel VT documents can be referenced at <http://www.intel.com/technology/virtualization/index.htm>.

3.1.1 Intel VT-x Objectives

Intel VT-x provides hardware acceleration for virtualization of IA platforms. Virtual Machine Monitor (VMM) can use Intel VT-x features to provide improved reliable virtualized platform. By using Intel VT-x, a VMM is:

- **Robust:** VMMs no longer need to use para-virtualization or binary translation. This means that they will be able to run off-the-shelf OS's and applications without any special steps.
- **Enhanced:** Intel VT enables VMMs to run 64-bit guest operating systems on IA x86 processors.
- **More reliable:** Due to the hardware support, VMMs can now be smaller, less complex, and more efficient. This improves reliability and availability and reduces the potential for software conflicts.
- **More secure:** The use of hardware transitions in the VMM strengthens the isolation of VMs and further prevents corruption of one VM from affecting others on the same system.

3.1.2 Intel VT-x Features

The processor core supports the following Intel VT-x features:

- Extended Page Tables (EPT)
 - hardware assisted page table virtualization
 - eliminates VM exits from guest OS to the VMM for shadow page-table maintenance
- Virtual Processor IDs (VPID)
 - Ability to assign a VM ID to tag processor core hardware structures (for example, TLBs)
 - This avoids flushes on VM transitions to give a lower-cost VM transition time and an overall reduction in virtualization overhead.
- Guest Preemption Timer
 - Mechanism for a VMM to preempt the execution of a guest OS after an amount of time specified by the VMM. The VMM sets a timer value before entering a guest
 - The feature aids VMM developers in flexibility and Quality of Service (QoS) guarantees
- Descriptor-Table Exiting
 - Descriptor-table exiting allows a VMM to protect a guest OS from internal (malicious software based) attack by preventing relocation of key system data structures like IDT (interrupt descriptor table), GDT (global descriptor table), LDT (local descriptor table), and TSS (task segment selector).
 - A VMM using this feature can intercept (by a VM exit) attempts to relocate these data structures and prevent them from being tampered by malicious software.
- Pause Loop Exiting (PLE)
 - PLE aims to improve virtualization performance and enhance the scaling of virtual machines with multiple virtual processors
 - PLE attempts to detect lock-holder preemption in a VM and helps the VMM to make better scheduling decisions

3.1.3 Intel VT-d Objectives

The key Intel VT-d objectives are domain-based isolation and hardware-based virtualization. A domain can be abstractly defined as an isolated environment in a platform to which a subset of host physical memory is allocated. Virtualization allows for the creation of one or more partitions on a single system. This could be multiple partitions in the same operating system, or there can be multiple operating system instances running on the same system – offering benefits such as system consolidation, legacy migration, activity partitioning or security.

3.1.3.1 Intel VT-d Features Supported

The processor supports the following Intel VT-d features:

- Root entry, context entry, and default context
- Support for 4-K page sizes only
- Support for register-based fault recording only (for single entry only) and support for MSI interrupts for faults



- Support for fault collapsing based on Requester ID
- Support for both leaf and non-leaf caching
- Support for boot protection of default page table
 - Support for non-caching of invalid page table entries
- Support for hardware based flushing of translated but pending writes and pending reads upon IOTLB invalidation.
- Support for page-selective IOTLB invalidation.
- Support for ARI (Alternative Requester ID - a PCI SIG ECR for increasing the function number count in a PCIe* device) to support IOV devices.
- Improved invalidation architecture
- End point caching support (ATS)
- Interrupt remapping

3.1.4 Intel Virtualization Technology Processor Extensions

The processor supports the following Intel VT Processor Extensions features:

- Large Intel VT-d Pages
 - Adds 2 MB and 1 GB page sizes to Intel VT-d implementations
 - Matches current support for Extended Page Tables (EPT)
 - Ability to share CPU's EPT page-table (with super-pages) with Intel VT-d
 - Benefits:
 - Less memory foot-print for I/O page-tables when using super-pages
 - Potential for improved performance - Due to shorter page-walks, allows hardware optimization for IOTLB
- Transition latency reductions expected to improve virtualization performance without the need for VMM enabling. This reduces the VMM overheads further and increase virtualization performance.

3.2 Security Technologies

3.2.1 Intel® Trusted Execution Technology

Intel® Trusted Execution Technology (Intel® TXT) defines platform-level enhancements that provide the building blocks for creating trusted platforms.

The Intel TXT platform helps to provide the authenticity of the controlling environment such that those wishing to rely on the platform can make an appropriate trust decision. The Intel TXT platform determines the identity of the controlling environment by accurately measuring and verifying the controlling software.

Another aspect of the trust decision is the ability of the platform to resist attempts to change the controlling environment. The Intel TXT platform will resist attempts by software processes to change the controlling environment or bypass the bounds set by the controlling environment.

Intel TXT is a set of extensions designed to provide a measured and controlled launch of system software that will then establish a protected environment for itself and any additional software that it may execute.



These extensions enhance two areas:

- The launching of the Measured Launched Environment (MLE).
- The protection of the MLE from potential corruption.

The enhanced platform provides these launch and control interfaces using Safer Mode Extensions (SMX).

The SMX interface includes the following functions:

- Measured/Verified launch of the MLE.
- Mechanisms to ensure the above measurement is protected and stored in a secure location.
- Protection mechanisms that allow the MLE to control attempts to modify itself.

For more information refer to the *Intel® Trusted Execution Technology Software Development Guide*. For more information on Intel Trusted Execution Technology, see <http://www.intel.com/technology/security/>

3.2.2 Intel Trusted Execution Technology – Server Extensions

- Software binary compatible with Intel Trusted Execution Technology Server Extensions
- Provides measurement of runtime firmware, including SMM
- Enables run-time firmware in trusted session: BIOS and SSP
- Covers support for existing and expected future Server RAS features
- Only requires portions of BIOS to be trusted, for example, Option ROMs need not be trusted
- Supports S3 State without teardown: Since BIOS is part of the trust chain

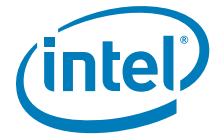
3.2.3 Intel® Advanced Encryption Standard Instructions (Intel® AES-NI)

These instructions enable fast and secure data encryption and decryption, using the Intel® AES New Instructions (Intel® AES-NI), which is defined by FIPS Publication number 197. Since Intel AES-NI is the dominant block cipher, and it is deployed in various protocols, the new instructions will be valuable for a wide range of applications.

The architecture consists of six instructions that offer full hardware support for Intel AES-NI. Four instructions support the Intel AES-NI encryption and decryption, and the other two instructions support the Intel AES-NI key expansion. Together, they offer a significant increase in performance compared to pure software implementations.

The Intel AES-NI instructions have the flexibility to support all three standard Intel AES-NI key lengths, all standard modes of operation, and even some nonstandard or future variants.

Beyond improving performance, the Intel AES-NI instructions provide important security benefits. Since the instructions run in data-independent time and do not use lookup tables, they help in eliminating the major timing and cache-based attacks that threaten table-based software implementations of Intel AES-NI. In addition, these instructions make AES simple to implement, with reduced code size. This helps reducing the risk of inadvertent introduction of security flaws, such as difficult-to-detect side channel leaks.



3.2.4 Execute Disable Bit

Intel's Execute Disable Bit functionality can help prevent certain classes of malicious buffer overflow attacks when combined with a supporting operating system.

- Allows the processor to classify areas in memory by where application code can execute and where it cannot.
- When a malicious worm attempts to insert code in the buffer, the processor disables code execution, preventing damage and worm propagation.

3.3 Intel® Hyper-Threading Technology

The processor supports Intel® Hyper-Threading Technology (Intel® HT Technology), which allows an execution core to function as two logical processors. While some execution resources such as caches, execution units, and buses are shared, each logical processor has its own architectural state with its own set of general-purpose registers and control registers. This feature must be enabled via the BIOS and requires operating system support. For more information on Intel Hyper-Threading Technology, see http://www.intel.com/products/ht/hyperthreading_more.htm.

3.4 Intel® Turbo Boost Technology

Intel® Turbo Boost Technology is a feature that allows the processor to opportunistically and automatically run faster than its rated operating frequency if it is operating below power, temperature, and current limits. The result is increased performance in multi-threaded and single threaded workloads. It should be enabled in the BIOS for the processor to operate with maximum performance.

3.4.1 Intel® Turbo Boost Operating Frequency

The processor's rated frequency assumes that all execution cores are running an application at the thermal design power (TDP). However, under typical operation, not all cores are active. Therefore most applications are consuming less than the TDP at the rated frequency. To take advantage of the available TDP headroom, the active cores can increase their operating frequency.

To determine the highest performance frequency amongst active cores, the processor takes the following into consideration:

- The number of cores operating in the C0 state.
- The estimated current consumption.
- The estimated power consumption.
- The die temperature.

Any of these factors can affect the maximum frequency for a given workload. If the power, current, or thermal limit is reached, the processor will automatically reduce the frequency to stay with its TDP limit.

Note: Intel Turbo Boost Technology is only active if the operating system is requesting the P0 state. For more information on P-states and C-states refer to [Section 4, "Power Management"](#).

3.5 Enhanced Intel SpeedStep® Technology

The processor supports Enhanced Intel SpeedStep® Technology as an advanced means of enabling very high performance while also meeting the power-conservation needs of the platform.

Enhanced Intel SpeedStep Technology builds upon that architecture using design strategies that include the following:

- **Separation between Voltage and Frequency Changes.** By stepping voltage up and down in small increments separately from frequency changes, the processor is able to reduce periods of system unavailability (which occur during frequency change). Thus, the system is able to transition between voltage and frequency states more often, providing improved power/performance balance.
- **Clock Partitioning and Recovery.** The bus clock continues running during state transition, even when the core clock and Phase-Locked Loop are stopped, which allows logic to remain active. The core clock is also able to restart more quickly under Enhanced Intel SpeedStep Technology.

For additional information on Enhanced Intel SpeedStep Technology see [Section 4.2.1](#).

3.6 Intel® Intelligent Power Technology

Intel® Intelligent Power Technology conserves power while delivering advanced power-management capabilities at the rack, group, and data center level. Providing the highest system-level performance per watt with “Automated Low Power States” and “Integrated Power Gates”. Improvements to this processor generation are:

- Intel Network Power Management Technology
- Intel Power Tuning Technology

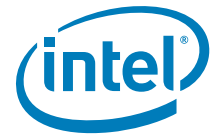
For more information on Intel Intelligent Power Technology, see this link <http://www.intel.com/technology/intelligentpower/>.

3.7 Intel® Advanced Vector Extensions (Intel® AVX)

Intel® Advanced Vector Extensions (Intel® AVX) is a new 256-bit vector SIMD extension of Intel Architecture. The introduction of Intel AVX starts with the 2nd Generation Intel(r) Core(TM) Processor Family. Intel AVX accelerates the trend of parallel computation in general purpose applications like image, video, and audio processing, engineering applications such as 3D modeling and analysis, scientific simulation, and financial analysts.

Intel AVX is a comprehensive ISA extension of the Intel® 64 Architecture. The main elements of Intel AVX are:

- Support for wider vector data (up to 256-bit) for floating-point computation.
- Efficient instruction encoding scheme that supports 3 operand syntax and headroom for future extensions.
- Flexibility in programming environment, ranging from branch handling to relaxed memory alignment requirements.
- New data manipulation and arithmetic compute primitives, including broadcast, permute, fused-multiply-add, and so forth.



The key advantages of Intel AVX are:

- **Performance** - Intel AVX can accelerate application performance via data parallelism and scalable hardware infrastructure across existing and new application domains:
 - 256-bit vector data sets can be processed up to twice the throughput of 128-bit data sets.
 - Application performance can scale up with number of hardware threads and number of cores.
 - Application domain can scale out with advanced platform interconnect fabrics, such as Intel QPI.
- **Power Efficiency** - Intel AVX is extremely power efficient. Incremental power is insignificant when the instructions are unused or scarcely used. Combined with the high performance that it can deliver, applications that lend themselves heavily to using Intel AVX can be much more energy efficient and realize a higher performance-per-watt.
- **Extensibility** - Intel AVX has built-in extensibility for the future vector extensions:
 - OS context management for vector-widths beyond 256 bits is streamlined.
 - Efficient instruction encoding allows unlimited functional enhancements:
 - Vector width support beyond 256 bits
 - 256-bit Vector Integer processing
 - Additional computational and/or data manipulation primitives.
- **Compatibility** - Intel AVX is backward compatible with previous ISA extensions including Intel® SSE4:
 - Existing Intel SSE applications/library can:
 - Run unmodified and benefit from processor enhancements
 - Recompile existing Intel SSE intrinsic using compilers that generate Intel AVX code
 - Inter-operate with library ported to Intel AVX
 - Applications compiled with Intel AVX can inter-operate with existing Intel SSE libraries.

3.8 Intel® Dynamic Power Technology (Intel® DPT)

Intel® Dynamic Power Technology (Intel® DPT) (Memory Power Management) is a platform feature with the ability to transition memory components into various low power states based on workload requirements. The Intel® Xeon® processor E5-1600/E5-2600/E5-4600 product families platform supports Dynamic CKE (hardware assisted) and Memory Self Refresh (software assisted). For further details refer to the *ACPI Specifications for Memory Power Management* document.

§





4 Power Management

This chapter provides information on the following power management topics:

- ACPI States
- System States
- Processor Core/Package States
- Integrated Memory Controller (IMC) and System Memory States
- Direct Media Interface Gen 2 (DMI2)/PCI Express* Link States
- Intel QuickPath Interconnect States

4.1 ACPI States Supported

The ACPI states supported by the processor are described in this section.

4.1.1 System States

Table 4-1. System States

State	Description
G0/S0	Full On
G1/S3-Cold	Suspend-to-RAM (STR). Context saved to memory
G1/S4	Suspend-to-Disk (STD). All power lost (except wakeup on PCH).
G2/S5	Soft off. All power lost (except wakeup on PCH). Total reboot.
G3	Mechanical off. All power removed from system.

4.1.2 Processor Package and Core States

Table 4-2 lists the package C-state support as: 1) the shallowest core C-state that allows entry into the package C-state, 2) the additional factors that will restrict the state from going any deeper, and 3) the actions taken with respect to the Ring Vcc, PLL state and LLC.

Table 4-3 lists the processor core C-states support.

Table 4-2. Package C-State Support (Sheet 1 of 2)

Package C-State	Core States	Limiting Factors	Retention and PLL-Off	LLC Fully Flushed	Notes ¹
PC0 - Active	CC0	N/A	No	No	2
PC2 - Snoopable Idle	CC3-CC7	<ul style="list-style-type: none"> • PCIe/PCH and Remote Socket Snoops • PCIe/PCH and Remote Socket Accesses • Interrupt response time requirement • DMI Sidebands • Configuration Constraints 	VccMin Freq = MinFreq PLL = ON	No	2



Table 4-2. Package C-State Support (Sheet 2 of 2)

Package C-State	Core States	Limiting Factors	Retention and PLL-Off	LLC Fully Flushed	Notes ¹
PC3 - Light Retention	at least one Core in C3	<ul style="list-style-type: none"> Core C-state Snoop Response Time Interrupt Response Time Non Snoop Response Time 	Vcc = retention PLL = OFF	No	2,3,4
PC6 - Deeper Retention	CC6-CC7	<ul style="list-style-type: none"> LLC ways open Snoop Response Time Non Snoop Response Time Interrupt Response Time 	Vcc = retention PLL = OFF	No	2,3,4

Notes:

- Package C7 is not supported.
- All package states are defined to be "E" states - such that they always exit back into the LFM point upon execution resume
- The mapping of actions for PC3, and PC6 are suggestions - microcode will dynamically determine which actions should be taken based on the desired exit latency parameters.
- CC3/CC6 will all use a voltage below the VccMin operational point; The exact voltage selected will be a function of the snoop and interrupt response time requirements made by the devices (PCIe* and DMI) and the operating system.

Table 4-3. Core C-State Support

Core C-State	Global Clock	PLL	L1/L2 Cache	Core VCC	Context
CC0	Running	On	Coherent	Active	Maintained
CC1	Stopped	On	Coherent	Active	Maintained
CC1E	Stopped	On	Coherent	Request LFM	Maintained
CC3	Stopped	On	Flushed to LLC	Request Retention	Maintained
CC6	Stopped	Off	Flushed to LLC	Power Gate	Flushed to LLC
CC7	Stopped	Off	Flushed to LLC	Power Gate	Flushed to LLC

4.1.3 Integrated Memory Controller States

Table 4-4. System Memory Power States (Sheet 1 of 2)

State	Description
Power Up/Normal Operation	CKE asserted. Active Mode, highest power consumption.
CKE Power Down	<p>Opportunistic, per rank control after idle time:</p> <ul style="list-style-type: none"> Active Power Down (APD) (default mode) <ul style="list-style-type: none"> CKE de-asserted. Power savings in this mode, relative to active idle state is about 55% of the memory power. Exiting this mode takes 3 – 5 DCLK cycles. Pre-charge Power Down Fast Exit (PPDF) <ul style="list-style-type: none"> CKE de-asserted. DLL-On. Also known as Fast CKE. Power savings in this mode, relative to active idle state is about 60% of the memory power. Exiting this mode takes 3 – 5 DCLK cycles. Pre-charge Power Down Slow Exit (PPDS) <ul style="list-style-type: none"> CKE de-asserted. DLL-Off. Also known as Slow CKE. Power savings in this mode, relative to active idle state is about 87% of the memory power. Exiting this mode takes 3 – 5 DCLK cycles until the first command is allowed and 16 cycles until first data is allowed. Register CKE Power Down: <ul style="list-style-type: none"> IBT-ON mode: Both CKE's are de-asserted, the Input Buffer Terminators (IBTs) are left "on". IBT-OFF mode: Both CKE's are de-asserted, the Input Buffer Terminators (IBTs) are turned "off".



Table 4-4. System Memory Power States (Sheet 2 of 2)

State	Description
Self-Refresh	<p>CKE de-asserted. In this mode, no transactions are executed and the system memory consumes the minimum possible power. Self refresh modes apply to all memory channels for the processor.</p> <ul style="list-style-type: none"> IO-MDLL Off: Option that sets the IO master DLL off when self refresh occurs. PLL Off: Option that sets the PLL off when self refresh occurs. <p>In addition, the register component found on registered DIMMs (RDIMMs) is complemented with the following power down states:</p> <ul style="list-style-type: none"> — Clock Stopped Power Down with IBT-On — Clock Stopped Power Down with IBT-Off

4.1.4 DMI2/PCI Express Link States

Table 4-5. DMI2/PCI Express* Link States

State	Description
L0	Full on – Active transfer state.
L1	Lowest Active State Power Management (ASPM) - Longer exit latency.

Note: L1 is only supported when the DMI2/PCI Express* port is operating as a PCI Express* port.

4.1.5 Intel QuickPath Interconnect States

Table 4-6. Intel QPI States

State	Description
L0	Link on. This is the power on active working state,
L0p	A lower power state from L0 that reduces the link from full width to half width
L1	A low power state with longer latency and lower power than L0s and is activated in conjunction with package C-states below C0.

4.1.6 G, S, and C State Combinations

Table 4-7. G, S and C State Combinations

Global (G) State	Sleep (S) State	Processor Core (C) State	Processor State	System Clocks	Description
G0	S0	C0	Full On	On	Full On
G0	S0	C1/C1E	Auto-Halt	On	Auto-Halt
G0	S0	C3	Deep Sleep	On	Deep Sleep
G0	S0	C6/C7	Deep Power Down	On	Deep Power Down
G1	S3	Power off		Off, except RTC	Suspend to RAM
G1	S4	Power off		Off, except RTC	Suspend to Disk
G2	S5	Power off		Off, except RTC	Soft Off
G3	N/A	Power off		Power off	Hard off

4.2 Processor Core/Package Power Management

While executing code, Enhanced Intel SpeedStep Technology optimizes the processor's frequency and core voltage based on workload. Each frequency and voltage operating point is defined by ACPI as a P-state. When the processor is not executing code, it is idle. A low-power idle state is defined by ACPI as a C-state. In general, lower power C-states have longer entry and exit latencies.

4.2.1 Enhanced Intel SpeedStep® Technology

The following are the key features of Enhanced Intel SpeedStep Technology:

- Multiple frequency and voltage points for optimal performance and power efficiency. These operating points are known as P-states.
- Frequency selection is software controlled by writing to processor MSRs. The voltage is optimized based on temperature, leakage, power delivery loadline and dynamic capacitance.
 - If the target frequency is higher than the current frequency, V_{CC} is ramped up to an optimized voltage. This voltage is signaled by the SVID Bus to the voltage regulator. Once the voltage is established, the PLL locks on to the target frequency.
 - If the target frequency is lower than the current frequency, the PLL locks to the target frequency, then transitions to a lower voltage by signaling the target voltage on the SVID Bus.
 - All active processor cores share the same frequency and voltage. In a multi-core processor, the highest frequency P-state requested amongst all active cores is selected.
 - Software-requested transitions are accepted at any time. The processor has a new capability from the previous processor generation, it can preempt the previous transition and complete the new request without waiting for this request to complete.
- The processor controls voltage ramp rates internally to ensure glitch-free transitions.
- Because there is low transition latency between P-states, a significant number of transitions per second are possible.

4.2.2 Low-Power Idle States

When the processor is idle, low-power idle states (C-states) are used to save power. More power savings actions are taken for numerically higher C-states. However, higher C-states have longer exit and entry latencies. Resolution of C-states occurs at the thread, processor core, and processor package level. Thread level C-states are available if Hyper-Threading Technology is enabled. Entry and exit of the C-States at the thread and core level are shown in [Figure 4-2](#).



Figure 4-1. Idle Power Management Breakdown of the Processor Cores

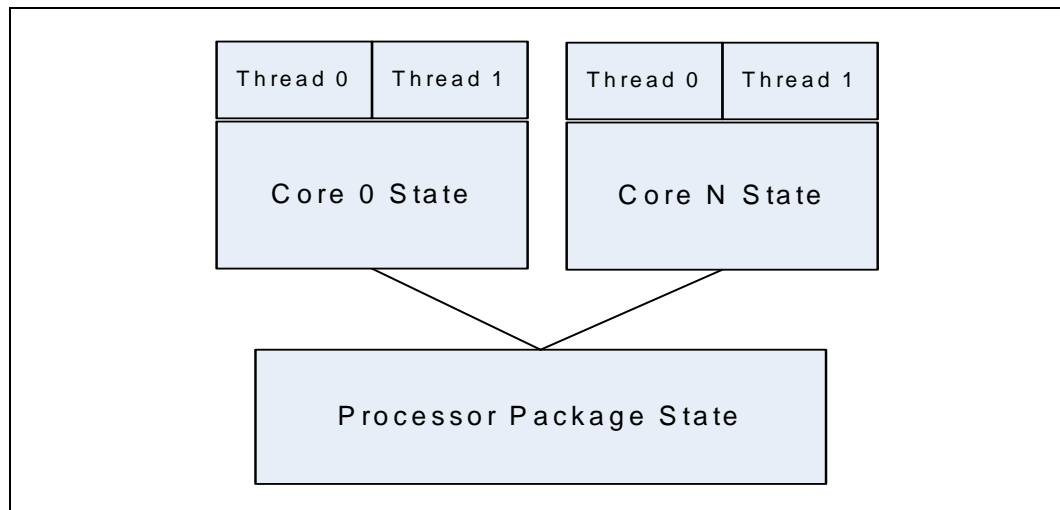
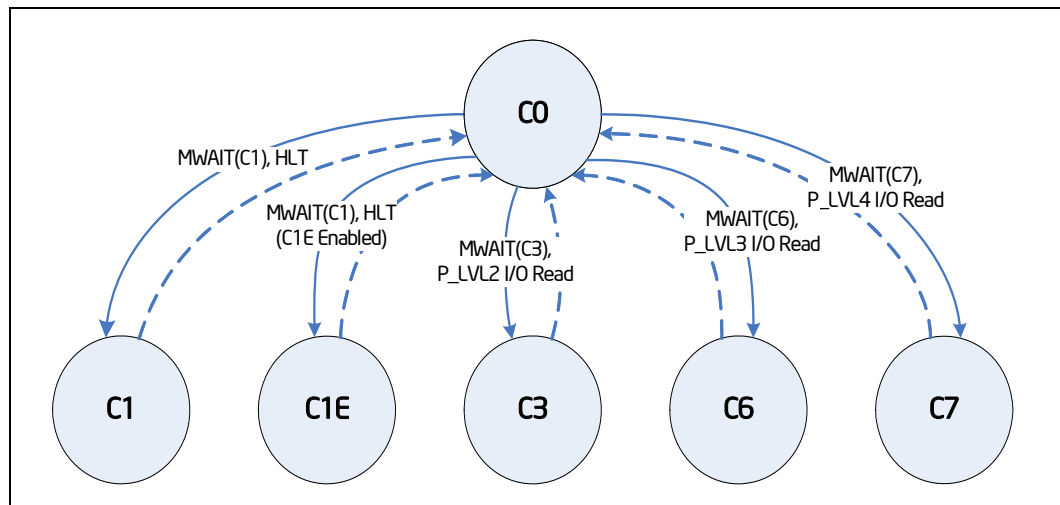


Figure 4-2. Thread and Core C-State Entry and Exit



While individual threads can request low power C-states, power saving actions only take place once the core C-state is resolved. Core C-states are automatically resolved by the processor. For thread and core C-states, a transition to and from C0 is required before entering any other C-state.

4.2.3 Requesting Low-Power Idle States

The core C-state will be C1E if all active cores have also resolved a core C1 state or higher.

The primary software interfaces for requesting low power idle states are through the MWAIT instruction with sub-state hints and the HLT instruction (for C1 and C1E). However, software may make C-state requests using the legacy method of I/O reads from the ACPI-defined processor clock control registers, referred to as P_LVLx. This method of requesting C-states provides legacy support for operating systems that initiate C-state transitions via I/O reads.



For legacy operating systems, P_LVLx I/O reads are converted within the processor to the equivalent MWAIT C-state request. Therefore, P_LVLx reads do not directly result in I/O reads to the system. The feature, known as I/O MWAIT redirection, must be enabled in the BIOS. To enable it, refer to the *Intel® 64 and IA-32 Architectures Software Developer's Manual (SDM) Volumes 1, 2, and 3*.

Note: The P_LVLx I/O Monitor address needs to be set up before using the P_LVLx I/O read interface. Each P_LVLx is mapped to the supported MWAIT(Cx) instruction as follows.

Table 4-8. P_LVLx to MWAIT Conversion

P_LVLx	MWAIT(Cx)	Notes
P_LVL2	MWAIT(C3)	The P_LVL2 base address is defined in the PMG_IO_CAPTURE MSR, described in the <i>Intel® 64 and IA-32 Architectures Software Developer's Manual (SDM) Volumes 1, 2, and 3</i> .
P_LVL3	MWAIT(C6)	C6. No sub-states allowed.
P_LVL4	MWAIT(C7)	C7. No sub-states allowed.

The BIOS can write to the C-state range field of the PMG_IO_CAPTURE MSR to restrict the range of I/O addresses that are trapped and emulate MWAIT like functionality. Any P_LVLx reads outside of this range does not cause an I/O redirection to MWAIT(Cx) like request. They fall through like a normal I/O instruction.

Note: When P_LVLx I/O instructions are used, MWAIT substates cannot be defined. The MWAIT substate is always zero if I/O MWAIT redirection is used. By default, P_LVLx I/O redirections enable the MWAIT 'break on EFLAGS.IF' feature which triggers a wakeup on an interrupt even if interrupts are masked by EFLAGS.IF.

4.2.4 Core C-states

The following are general rules for all core C-states, unless specified otherwise:

- A core C-State is determined by the lowest numerical thread state (for example, Thread 0 requests C1E while Thread 1 requests C3, resulting in a core C1E state). See [Table 4-7](#).
- A core transitions to C0 state when:
 - an interrupt occurs.
 - there is an access to the monitored address if the state was entered via an MWAIT instruction.
- For core C1/C1E, and core C3, an interrupt directed toward a single thread wakes only that thread. However, since both threads are no longer at the same core C-state, the core resolves to C0.
- An interrupt only wakes the target thread for both C3 and C6 states. Any interrupt coming into the processor package may wake any core.

4.2.4.1 Core C0 State

The normal operating state of a core where code is being executed.

4.2.4.2 Core C1/C1E State

C1/C1E is a low power state entered when all threads within a core execute a HLT or MWAIT(C1/C1E) instruction.



A System Management Interrupt (SMI) handler returns execution to either Normal state or the C1/C1E state. See the *Intel® 64 and IA-32 Architectures Software Developer's Manual (SDM) Volumes 1, 2, and 3* for more information.

While a core is in C1/C1E state, it processes bus snoops and snoops from other threads. For more information on C1E, see [Section 4.2.5.2, "Package C1/C1E"](#).

4.2.4.3 Core C3 State

Individual threads of a core can enter the C3 state by initiating a P_LVL2 I/O read to the P_BLK or an MWAIT(C3) instruction. A core in C3 state flushes the contents of its L1 instruction cache, L1 data cache, and L2 cache to the shared L3 cache, while maintaining its architectural state. All core clocks are stopped at this point. Because the core's caches are flushed, the processor does not wake any core that is in the C3 state when either a snoop is detected or when another core accesses cacheable memory.

4.2.4.4 Core C6 State

Individual threads of a core can enter the C6 state by initiating a P_LVL3 I/O read or an MWAIT(C6) instruction. Before entering core C6, the core will save its architectural state to a dedicated SRAM. Once complete, a core will have its voltage reduced to zero volts. In addition to flushing core caches core architecture state is saved to the uncore. Once the core state save is completed, core voltage is reduced to zero. During exit, the core is powered on and its architectural state is restored.

4.2.4.5 Core C7 State

Individual threads of a core can enter the C7 state by initiating a P_LVL4 I/O read to the P_BLK or by an MWAIT(C7) instruction. Core C7 and core C7 substate are the same as Core C6. The processor does not support LLC flush under any condition.

4.2.4.6 C-State Auto-Demotion

In general, deeper C-states such as C6 or C7 have long latencies and have higher energy entry/exit costs. The resulting performance and energy penalties become significant when the entry/exit frequency of a deeper C-state is high. In order to increase residency in deeper C-states, the processor supports C-state auto-demotion.

There are two C-State auto-demotion options:

- C6/C7 to C3
- C3/C6/C7 To C1

The decision to demote a core from C6/C7 to C3 or C3/C6/C7 to C1 is based on each core's immediate residency history. Upon each core C6/C7 request, the core C-state is demoted to C3 or C1 until a sufficient amount of residency has been established. At that point, a core is allowed to go into C3/C6 or C7. Each option can be run concurrently or individually.

This feature is disabled by default. BIOS must enable it in the PMG_CST_CONFIG_CONTROL register. The auto-demotion policy is also configured by this register. See the *Intel® 64 and IA-32 Architectures Software Developer's Manual (SDM) Volumes 1, 2, and 3* for C-state configurations.

4.2.5 Package C-States

The processor supports C0, C1/C1E, C2, C3, and C6 power states. The following is a summary of the general rules for package C-state entry. These apply to all package C-states unless specified otherwise:

- A package C-state request is determined by the lowest numerical core C-state amongst all cores.
- A package C-state is automatically resolved by the processor depending on the core idle power states and the status of the platform components.
 - Each core can be at a lower idle power state than the package if the platform does not grant the processor permission to enter a requested package C-state.
 - The platform may allow additional power savings to be realized in the processor.
- For package C-states, the processor is not required to enter C0 before entering any other C-state.

The processor exits a package C-state when a break event is detected. Depending on the type of break event, the processor does the following:

- If a core break event is received, the target core is activated and the break event message is forwarded to the target core.
 - If the break event is not masked, the target core enters the core C0 state and the processor enters package C0.
 - If the break event is masked, the processor attempts to re-enter its previous package state.
- If the break event was due to a memory access or snoop request.
 - But the platform did not request to keep the processor in a higher package C-state, the package returns to its previous C-state.
 - And the platform requests a higher power C-state, the memory access or snoop request is serviced and the package remains in the higher power C-state.

The package C-states fall into two categories: independent and coordinated. C0/C1/C1E are independent, while C2/C3/C6 are coordinated.

Starting with the 2nd Generation Intel(r) Core(TM) Processor Family, package C-states are based on exit latency requirements which are accumulated from the PCIe* devices, PCH, and software sources. The level of power savings that can be achieved is a function of the exit latency requirement from the platform. As a result, there is no fixed relationship between the coordinated C-state of a package, and the power savings that will be obtained from the state. Coordinated package C-states offer a range of power savings which is a function of the guaranteed exit latency requirement from the platform.

There is also a concept of Execution Allowed (EA), when EA status is 0, the cores in a socket are in C3 or a deeper state, a socket initiates a request to enter a coordinated package C-state. The coordination is across all sockets and the PCH.

Table 4-9 shows an example of a dual-core processor package C-state resolution. Figure 4-3 summarizes package C-state transitions with package C2 as the interim between C0 and C1 prior to C3 and C6.



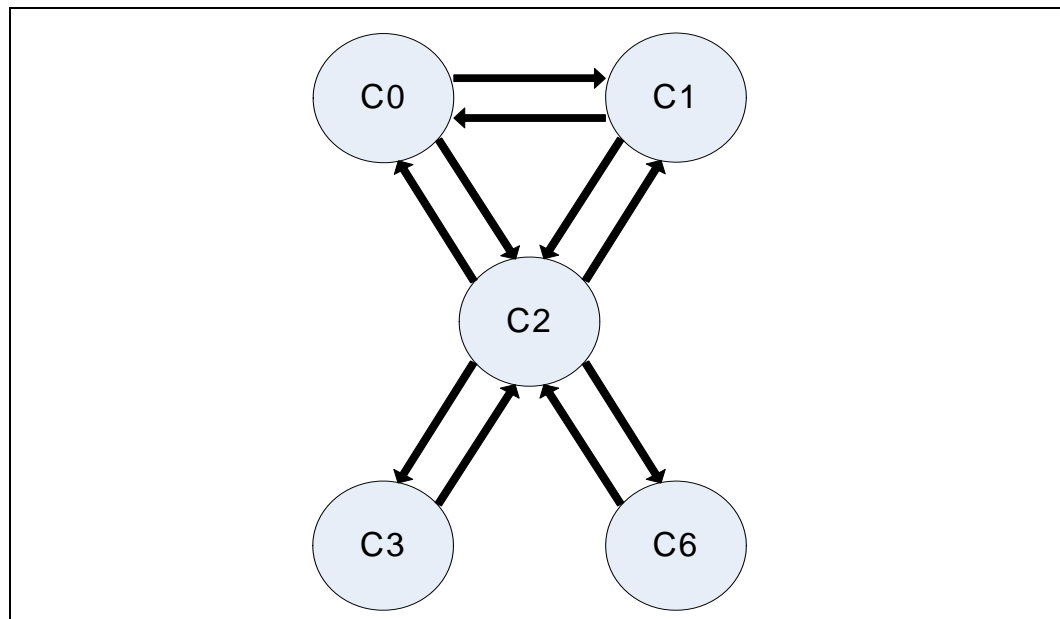
Table 4-9. Coordination of Core Power States at the Package Level

Package C-State		Core 1			
		C0	C1	C3	C6
Core 0	C0	C0	C0	C0	C0
	C1	C0	C1 ¹	C1 ¹	C1 ¹
	C3	C0	C1 ¹	C3	C3
	C6	C0	C1 ¹	C3	C6

Notes:

1. The package C-state will be C1E if all active cores have resolved a core C1 state or higher.

Figure 4-3. Package C-State Entry and Exit



4.2.5.1 Package C0

The normal operating state for the processor. The processor remains in the normal state when at least one of its cores is in the C0 or C1 state or when the platform has not granted permission to the processor to go into a low power state. Individual cores may be in lower power idle states while the package is in C0.

4.2.5.2 Package C1/C1E

No additional power reduction actions are taken in the package C1 state. However, if the C1E substate is enabled, the processor automatically transitions to the lowest supported core clock frequency, followed by a reduction in voltage. Autonomous power reduction actions which are based on idle timers, can trigger depending on the activity in the system.

The package enters the C1 low power state when:



- At least one core is in the C1 state.
- The other cores are in a C1 or lower power state.

The package enters the C1E state when:

- All cores have directly requested C1E via MWAIT(C1) with a C1E sub-state hint.
- All cores are in a power state lower than C1/C1E but the package low power state is limited to C1/C1E via the PMG_CST_CONFIG_CONTROL MSR.
- All cores have requested C1 using HLT or MWAIT(C1) and C1E auto-promotion is enabled in POWER_CTL.

No notification to the system occurs upon entry to C1/C1E.

4.2.5.3 Package C2 State

Package C2 state is an intermediate state which represents the point at which the system level coordination is in progress. The package cannot reach this state unless all cores are in at least C3.

The package will remain in C2 when:

- it is awaiting for a coordinated response
- the coordinated exit latency requirements are too stringent for the package to take any power saving actions

If the exit latency requirements are high enough the package will transition to C3 or C6 depending on the state of the cores.

4.2.5.4 Package C3 State

A processor enters the package C3 low power state when:

- At least one core is in the C3 state.
- The other cores are in a C3 or lower power state, and the processor has been granted permission by the platform.
- L3 shared cache retains context and becomes inaccessible in this state.
- Additional power savings actions, as allowed by the exit latency requirements, include putting Intel QPI and PCIe* links in L1, the uncore is not available, further voltage reduction can be taken.

In package C3, the ring will be off and as a result no accesses to the LLC are possible. The content of the LLC is preserved.

4.2.5.5 Package C6 State

A processor enters the package C6 low power state when:

- At least one core is in the C6 state.
- The other cores are in a C6 or lower power state, and the processor has been granted permission by the platform.
- L3 shared cache retains context and becomes inaccessible in this state.



- Additional power savings actions, as allowed by the exit latency requirements, include putting Intel QPI and PCIe* links in L1, the uncore is not available, further voltage reduction can be taken.

In package C6 state, all cores have saved their architectural state and have had their core voltages reduced to zero volts. The LLC retains context, but no accesses can be made to the LLC in this state, the cores must break out to the internal state package C2 for snoops to occur.

4.2.6 Package C-State Power Specifications

The table below lists the processor package C-state power specifications for various processor SKUs.

Table 4-10. Package C-State Power Specifications

TDP SKUs	C1E (W)	C3 (W)	C6 (W)
8-Core / 6-Core			
150W (8-core)	58	27	15
135W (8-core)	47	22	15
130W (8-core)	47	22	15
130W (6-core)	53	35	21
130W (6-core 1S WS)	53	35	21
115W (8-core)	47	22	15
95W (8-core)	47	22 35 (E5-2660)	15
95W (6-core)	48	22 35 (E5-2620)	15 21 (E5-2620)
70W (8-core)	39	20	14
60W (6-core)	38	20	14
LV95W-8C (8-core)	47	22	15
LV70W-8C (8-core)	39	20	14
4-Core / 2-Core			
130W (4-core)	53	28	16
130W (4-Core 1S WS)	53	28	16
95W (4-core)	47	22	15
80W (4-core)	42	21 30 (E5-2603)	16
80W (2-core)	42	30	21

- Notes:**
1. Package C1E power specified at Tcase = 60°C.
 2. Package C3/C6 power specified at Tcase = 50°C.

4.3 System Memory Power Management

The DDR3 power states can be summarized as the following:

- Normal operation (highest power consumption).

- CKE Power-Down: Opportunistic, per rank control after idle time. There may be different levels.
 - Active Power-Down.
 - Precharge Power-Down with Fast Exit.
 - Precharge power Down with Slow Exit.
- Self Refresh: In this mode no transaction is executed. The DDR consumes the minimum possible power.

4.3.1 CKE Power-Down

The CKE input land is used to enter and exit different power-down modes. The memory controller has a configurable activity timeout for each rank. Whenever no reads are present to a given rank for the configured interval, the memory controller will transition the rank to power-down mode.

The memory controller transitions the DRAM to power-down by de-asserting CKE and driving a NOP command. The memory controller will tri-state all DDR interface lands except CKE (de-asserted) and ODT while in power-down. The memory controller will transition the DRAM out of power-down state by synchronously asserting CKE and driving a NOP command.

When CKE is off the internal DDR clock is disabled and the DDR power is significantly reduced.

The DDR defines three levels of power-down:

- Active power-down.
- Precharge power-down fast exit.
- Precharge power-down slow exit.

4.3.2 Self Refresh

The Power Control Unit (PCU) may request the memory controller to place the DRAMs in self refresh state. Self refresh per channel is supported. The BIOS can put the channel in self-refresh if software remaps memory to use a subset of all channels. Also processor channels can enter self refresh autonomously without PCU instruction when the package is in a package C0 state.

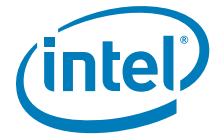
4.3.2.1 Self Refresh Entry

Self refresh entrance can be either disabled or triggered by an idle counter. The idle counter always clears with any access to the memory controller and remains clear as long as the memory controller is not drained. As soon as the memory controller is drained, the counter starts counting, and when it reaches the idle-count, the memory controller will place the DRAMs in self refresh state.

Power may be removed from the memory controller core at this point. But V_{CCD} supply (1.5 V or 1.35 V) to the DDR IO must be maintained.

4.3.2.2 Self Refresh Exit

Self refresh exit can be either a message from an external unit or as reaction for an incoming transaction.



4.3.2.3 DLL and PLL Shutdown

Self refresh, according to configuration, may be a trigger for master DLL shut-down and PLL shut-down. The master DLL shut-down is issued by the memory controller after the DRAMs have entered self refresh.

The PLL shut-down and wake-up is issued by the PCU. The memory controller gets a signal from PLL indicating that the memory controller can start working again.

4.3.3 DRAM I/O Power Management

Unused signals are tristated to save power. This includes all signals associated with an unused memory channel.

The I/O buffer for an unused signal should be tristated (output driver disabled), the input receiver (differential sense-amp) should be disabled. The input path must be gated to prevent spurious results due to noise on the unused signals (typically handled automatically when input receiver is disabled).

4.4 DMI 2/PCI Express* Power Management

Active State Power Management (ASPM) support using L1 state, L0s is not supported.

§





5 Thermal Management Specifications

5.1 Package Thermal Specifications

The processor requires a thermal solution to maintain temperatures within operating limits. Any attempt to operate the processor outside these limits may result in permanent damage to the processor and potentially other components within the system, see [Section 7.7.1, "Storage Conditions Specifications"](#). Maintaining the proper thermal environment is key to reliable, long-term system operation.

A complete solution includes both component and system level thermal management features. Component level thermal solutions can include active or passive heatsinks attached to the processor integrated heat spreader (IHS). Typical system level thermal solutions may consist of system fans combined with ducting and venting.

This section provides data necessary for developing a complete thermal solution. For more information on designing a component level thermal solution, refer to the *Intel® Xeon® Processor E5-1600/E5-2600/E5-4600 Product Families Thermal/Mechanical Design Guide*.

5.1.1 Thermal Specifications

To allow optimal operation and long-term reliability of Intel processor-based systems, the processor must remain within the minimum and maximum case temperature (T_{CASE}) specifications as defined by the applicable thermal profile. Thermal solutions not designed to provide sufficient thermal capability may affect the long-term reliability of the processor and system. For more details on thermal solution design, please refer to the *Intel® Xeon® Processor E5-1600/E5-2600/E5-4600 Product Families Thermal/Mechanical Design Guide*.

The processors implement a methodology for managing processor temperatures which is intended to support acoustic noise reduction through fan speed control and to assure processor reliability. Selection of the appropriate fan speed is based on the relative temperature data reported by the processor's Platform Environment Control Interface (PECI) as described in [Section 2.5, "Platform Environment Control Interface \(PECI\)"](#).

If the DTS value is less than $T_{CONTROL}$, then the case temperature is permitted to exceed the Thermal Profile, but the DTS value must remain at or below $T_{CONTROL}$.

For T_{CASE} implementations, if DTS is greater than $T_{CONTROL}$, then the case temperature must meet the T_{CASE} based Thermal Profiles.

For DTS implementations:

- T_{CASE} thermal profile can be ignored during processor run time.
- If DTS is greater than $T_{CONTROL}$ then follow DTS thermal profile specifications for fan speed optimization.



The temperature reported over PECl is always a negative value and represents a delta below the onset of thermal control circuit (TCC) activation, as indicated by PROCHOT_N (see [Section 7, “Electrical Specifications”](#)). Systems that implement fan speed control must be designed to use this data. Systems that do not alter the fan speed need to guarantee the case temperature meets the thermal profile specifications.

Some processor SKUs support two thermal profiles; refer to [Table 5-1](#) for a summary of the planned SKUs and their supported thermal profiles. Both ensure adherence to Intel reliability requirements. Thermal Profile 2U is representative of a volumetrically unconstrained thermal solution (that is, industry enabled 2U heatsink). With single thermal profile, it is expected that the Thermal Control Circuit (TCC) would be activated for very brief periods of time when running the most power intensive applications. Thermal Profile 1U is indicative of a constrained thermal environment (that is, 1U form factor). Because of the reduced cooling capability represented by this thermal solution, the probability of TCC activation and performance loss is increased. Additionally, utilization of a thermal solution that does not meet Thermal Profile 1U will violate the thermal specifications and may result in permanent damage to the processor. Refer to the *Intel® Xeon® Processor E5-1600/E5-2600/E5-4600 Product Families Thermal/Mechanical Design Guide* for details on system thermal solution design, thermal profiles and environmental considerations. The upper point of the thermal profile consists of the Thermal Design Power (TDP) and the associated T_{CASE} value. It should be noted that the upper point associated with Thermal Profile 1U.

($x = TDP$ and $y = T_{CASE_MAX_B @ TDP}$) represents a thermal solution design point. In actuality the processor case temperature will not reach this value due to TCC activation.

For Embedded Servers, Communications and storage markets Intel has plan SKU's that support Thermal Profiles with nominal and short-term conditions designed to meet NEBS level 3 compliance. For these SKU's operation at either the nominal or short-term thermal profiles should result in virtually no TCC activation. Thermal Profiles for these SKU's are found in [Table 5-1](#).

Intel recommends that complete thermal solution designs target the Thermal Design Power (TDP). The Adaptive Thermal Monitor feature is intended to help protect the processor in the event that an application exceeds the TDP recommendation for a sustained time period. To ensure maximum flexibility for future requirements, systems should be designed to the Flexible Motherboard (FMB) guidelines, even if a processor with lower power dissipation is currently planned. **The Adaptive Thermal Monitor feature must be enabled for the processor to remain within its specifications.**

5.1.2 T_{CASE} and DTS Based Thermal Specifications

To simplify compliance to thermal specifications at processor run time, the processor has added a Digital Thermal Sensor (DTS) based thermal specification. Digital Thermal Sensor reports a relative die temperature as an offset from TCC activation temperature. T_{CASE} thermal based specifications are used for heat sink sizing and DTS based specs are used for acoustic and fan speed optimizations. For the processor family, firmware (for example, BMC or other platform management devices) will have DTS based specifications for all SKUs programmed by the customer. 8-core and 6-core SKUs may share T_{CASE} thermal profiles but they will have separate T_{DTS} based thermal profiles. See [Table 5-1](#) for the T_{CASE} and DTS SKU summary.

The processor fan speed control is managed by comparing DTS thermal readings via PECl against the processor-specific fan speed control reference point, or Tcontrol. Both Tcontrol and DTS thermal readings are accessible via the processor PECl client. At a one time readout only, the Fan Speed Control firmware will read the following:



- TEMPERATURE_TARGET MSR
- Tcontrol via PECI - RdPkgConfig()
- TDP via PECI - RdPkgConfig()
- Core Count - RdPCIConfigLocal()

DTS PECI commands will also support DTS temperature data readings. Please see [Section 2.5.7, "DTS Temperature Data"](#) for PECI command details.

Also, refer to the *Intel® Xeon® Processor E5-1600/E5-2600/E5-4600 Product Families Thermal/Mechanical Design Guide* for details on DTS based thermal solution design considerations.



5.1.3 Processor Thermal Profiles

Table 5-1. Processor SKU Summary Table

TDP SKUs	Thermal Profile	
	Tcase	DTS
8-Core / 6-Core		
150W (8-core)	Figure 5-1	Figure 5-2
135W (8-core)	Figure 5-3	Figure 5-4
130W (8-core)	Figure 5-5	Figure 5-6
130W (6-core)	Figure 5-5	Figure 5-7
130W (6-core 1S WS)	Figure 5-8	Figure 5-9
115W (8-core)	Figure 5-10	Figure 5-11
95W (8-core)	Figure 5-12	Figure 5-13
95W (6-core)	Figure 5-12	Figure 5-14
70W (8-core)	Figure 5-15	Figure 5-16
60W (6-core)	Figure 5-17	Figure 5-18
4-Core / 2-Core		
130W (4-core)	Figure 5-19	Figure 5-20
130W (4-core 1S WS)	Figure 5-21	Figure 5-22
95W (4-core) ¹	Figure 5-23	Figure 5-24
80W (4-core)	Figure 5-25	Figure 5-26
80W (2-core)	Figure 5-25	Figure 5-27

1. Applies only to Intel® Xeon® Processor E5-4600 Product Family.

5.1.3.1 8-Core 150W Thermal Specifications

Table 5-2. Tcase: 8-Core 150W Thermal Specifications, Workstation Platform SKU Only

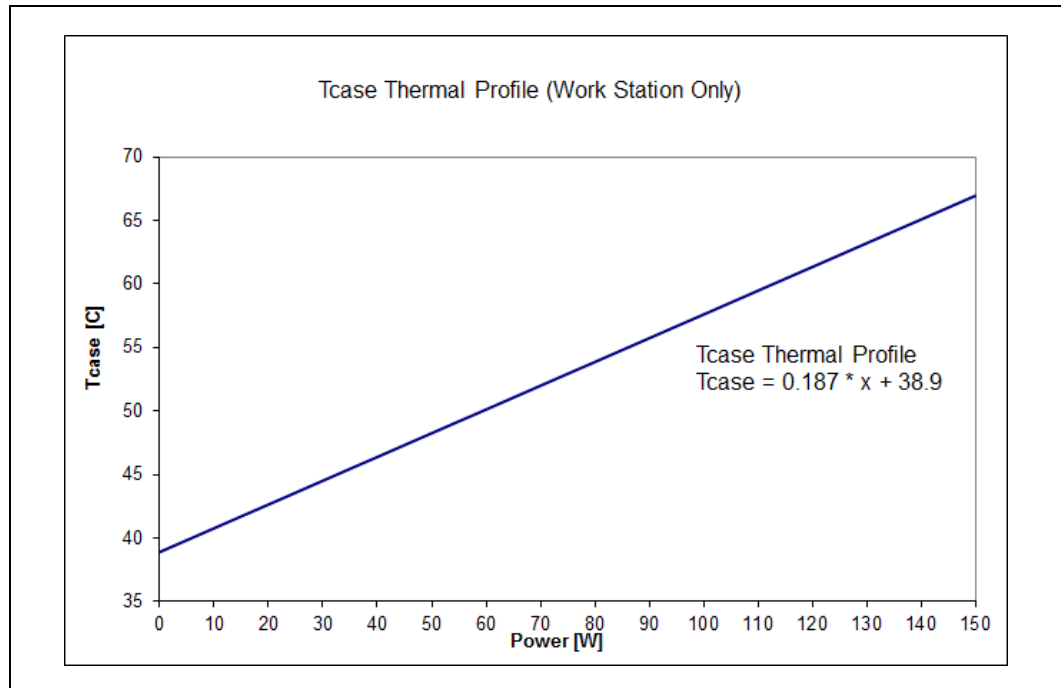
Core Frequency	Thermal Design Power (W)	Minimum T _{CASE} (°C)	Maximum T _{CASE} (°C)	Notes
Launch to FMB	150	5	See Figure 5-1 and Table 5-3	1, 2, 3, 4, 5, 6

Notes:

- These values are specified at V_{CC_MAX} for all processor frequencies. Systems must be designed to ensure the processor is not to be subjected to any static V_{CC} and I_{CC} combination wherein V_{CC} exceeds V_{CC_MAX} at specified ICC. Please refer to the electrical loadline specifications in Section 7.8.1.
- Thermal Design Power (TDP) should be used for processor thermal solution design targets. TDP is not the maximum power that the processor can dissipate. TDP is measured at maximum T_{CASE}.
- These specifications are based on final silicon characterization.
- Power specifications are defined at all VIDs found in Table 7-3. The processor may be delivered under multiple VIDs for each frequency.
- FMB, or Flexible Motherboard, guidelines provide a design target for meeting all planned processor frequency requirements.
- The 150W TDP SKU is intended for the dual processor workstations only and uses workstation specific use conditions for reliability assumptions.



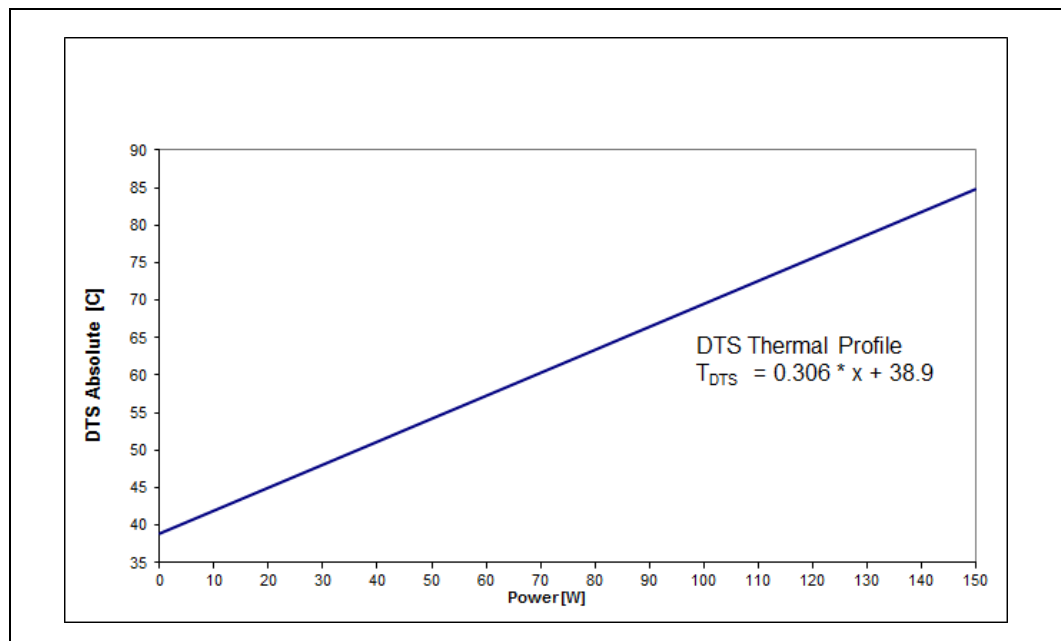
Figure 5-1. Tcase: 8-Core 150W Thermal Profile, Workstation Platform SKU Only



Notes:

1. This Thermal Profile is representative of a volumetrically unconstrained platform. Please refer to [Table 5-3](#) for discrete points that constitute the thermal profile.
2. Implementation of this Thermal Profile should result in virtually no TCC activation. Refer to the *Intel® Xeon® Processor E5-1600/E5-2600/E5-4600 Product Families Thermal/Mechanical Design Guide* for system and environmental implementation details.

Figure 5-2. DTS: 8-Core 150W Thermal Profile, Workstation Platform SKU Only



Notes:

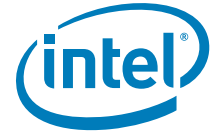
1. Some processor units may be tested to lower TDP and the TEMPERATURE_TARGET MSR will be aligned to that lower TDP.



2. This Thermal Profile is representative of a volumetrically unconstrained platform. Please refer to [Table 5-3](#) for discrete points that constitute the thermal profile.
3. Implementation of this Thermal Profile should result in virtually no TCC activation. Refer to the *Intel® Xeon® Processor E5-1600/E5-2600/E5-4600 Product Families Thermal/Mechanical Design Guide* for system and environmental implementation details.

Table 5-3. 8-Core 150W Thermal Profile, Workstation Platform SKU Only

Power (W)	Maximum T _{CASE} (°C)	Maximum DTS(°C)
0	38.9	38.9
5	39.8	40.4
10	40.8	42.0
15	41.7	43.5
20	42.6	45.0
25	43.6	46.6
30	44.5	48.1
35	45.4	49.6
40	46.4	51.1
45	47.3	52.7
50	48.3	54.2
55	49.2	55.7
60	50.1	57.3
65	51.1	58.8
70	52.0	60.3
75	52.9	61.9
80	53.9	63.4
85	54.8	64.9
90	55.7	66.4
95	56.7	68.0
100	57.6	69.5
105	58.5	71.0
110	59.5	72.6
115	60.4	74.1
120	61.3	75.6
125	62.3	77.2
130	63.2	78.7
135	64.1	80.2
140	65.1	81.7
145	66.0	83.3
150	67.0	84.8



5.1.3.2 8-Core 135W Thermal Specifications

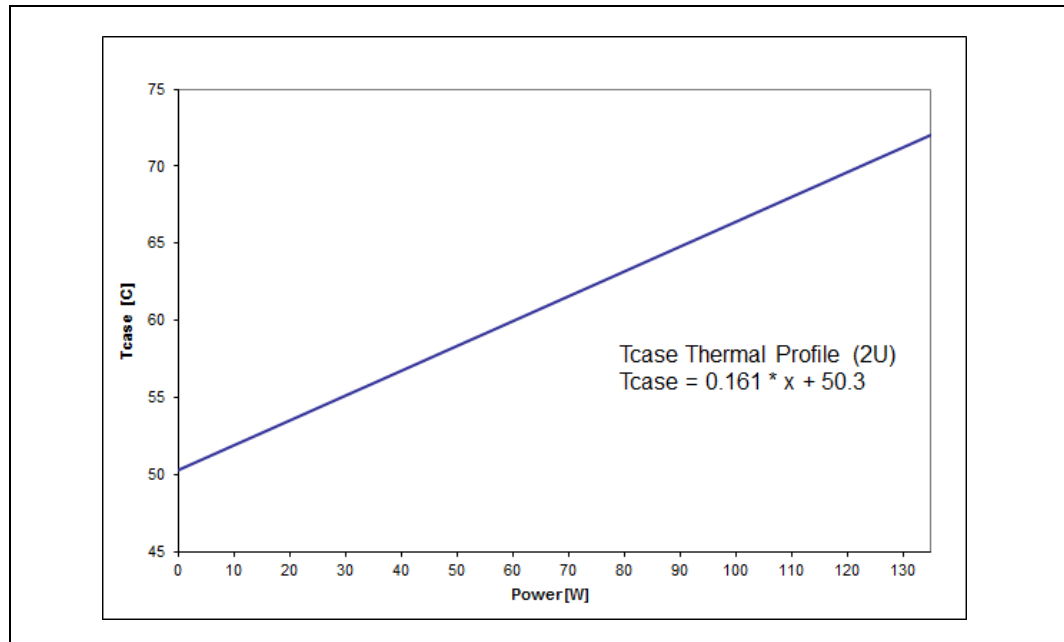
Table 5-4. Tcase: 8-Core 135W Thermal Specifications 2U

Core Frequency	Thermal Design Power (W)	Minimum T _{CASE} (°C)	Maximum T _{CASE} (°C)	Notes
Launch to FMB	135	5	See Figure 5-3 and Table 5-5	1, 2, 3, 4, 5

Notes:

1. These values are specified at V_{CC_MAX} for all processor frequencies. Systems must be designed to ensure the processor is not to be subjected to any static V_{CC} and I_{CC} combination wherein V_{CC} exceeds V_{CC_MAX} at specified ICC. Please refer to the electrical loadline specifications in Section 7.8.1.
2. Thermal Design Power (TDP) should be used for processor thermal solution design targets. TDP is not the maximum power that the processor can dissipate. TDP is measured at maximum T_{CASE}.
3. These specifications are based on final silicon characterization.
4. Power specifications are defined at all VIDs found in Table 7-3. The processor may be delivered under multiple VIDs for each frequency.
5. FMB, or Flexible Motherboard, guidelines provide a design target for meeting all planned processor frequency requirements.

Figure 5-3. Tcase: 8-Core 135W Thermal Profile 2U

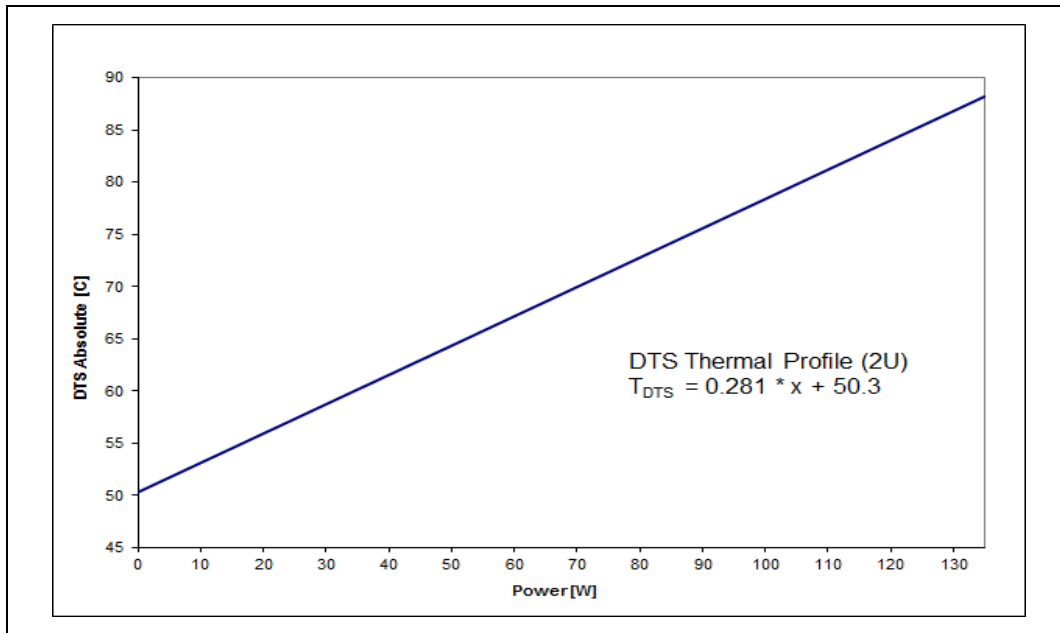


Notes:

1. This Thermal Profile is representative of a volumetrically unconstrained platform. Please refer to Table 5-5 for discrete points that constitute the thermal profile.
2. Implementation of this Thermal Profile should result in virtually no TCC activation. Refer to the *Intel® Xeon® Processor E5-1600/E5-2600/E5-4600 Product Families Thermal/Mechanical Design Guide* for system and environmental implementation details.



Figure 5-4. DTS: 8-Core 135W Thermal Profile 2U



Notes:

1. Some of the processor units may be tested to lower TDP and the TEMPERATURE_TARGET MSR will be aligned to that lower TDP.
2. This Thermal Profile is representative of a volumetrically unconstrained platform. Please refer to Table 5-5 for discrete points that constitute the thermal profile.
3. Implementation of this Thermal Profile should result in virtually no TCC activation. Refer to the *Intel® Xeon® Processor E5-1600/E5-2600/E5-4600 Product Families Thermal/Mechanical Design Guide* for system and environmental implementation details.

Table 5-5. 8-Core 135W Thermal Profile Table 2U (Sheet 1 of 2)

Power (W)	Maximum T _{CASE} (°C)	Maximum DTS (°C)
0	50.3	50.3
5	51.1	51.7
10	51.9	53.1
15	52.7	54.5
20	53.5	55.9
25	54.3	57.3
30	55.1	58.7
35	55.9	60.1
40	56.7	61.5
45	57.5	62.4
50	58.4	64.4
55	59.2	65.8
60	60.0	67.2
65	60.8	68.6
70	61.6	70.0
75	62.4	71.4

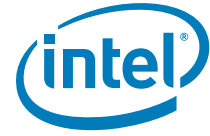


Table 5-5. 8-Core 135W Thermal Profile Table 2U (Sheet 2 of 2)

Power (W)	Maximum T _{CASE} (°C)	Maximum DTS (°C)
80	63.2	72.8
85	64.0	74.2
90	64.8	75.6
95	65.6	77.0
100	66.4	78.4
105	67.2	79.8
110	68.0	81.2
115	68.8	82.6
120	69.6	84.0
125	70.4	85.4
130	71.2	86.8
135	72.0	88.2

5.1.3.3 8/6-Core 130W Thermal Specifications

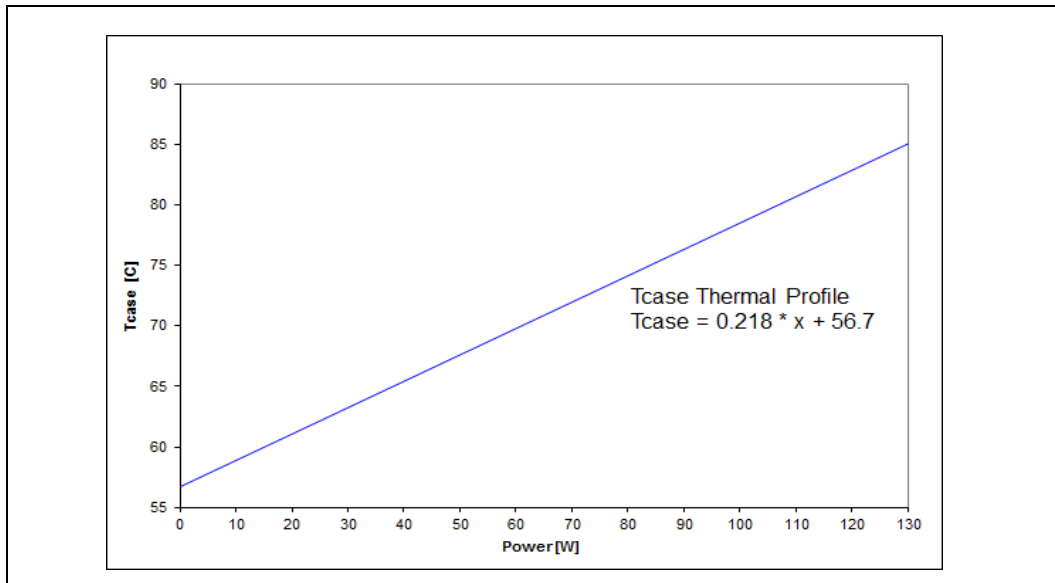
Table 5-6. Tcase: 8/6-Core 130W Thermal Specifications, Workstation/Server Platform

Core Frequency	Thermal Design Power (W)	Minimum T _{CASE} (°C)	Maximum T _{CASE} (°C)	Notes
Launch to FMB	130	5	See Figure 5-5 and Table 5-7.	1, 2, 3, 4, 5

Notes:

1. These values are specified at V_{CC_MAX} for all processor frequencies. Systems must be designed to ensure the processor is not to be subjected to any static V_{CC} and I_{CC} combination wherein V_{CC} exceeds V_{CC_MAX} at specified ICC. Please refer to the electrical loadline specifications in Section 7.8.1.
2. Thermal Design Power (TDP) should be used for processor thermal solution design targets. TDP is not the maximum power that the processor can dissipate. TDP is measured at maximum T_{CASE}.
3. These specifications are based on final silicon characterization.
4. Power specifications are defined at all VIDs found in Table 7-3. The processor may be delivered under multiple VIDs for each frequency.
5. FMB, or Flexible Motherboard, guidelines provide a design target for meeting all planned processor frequency requirements.

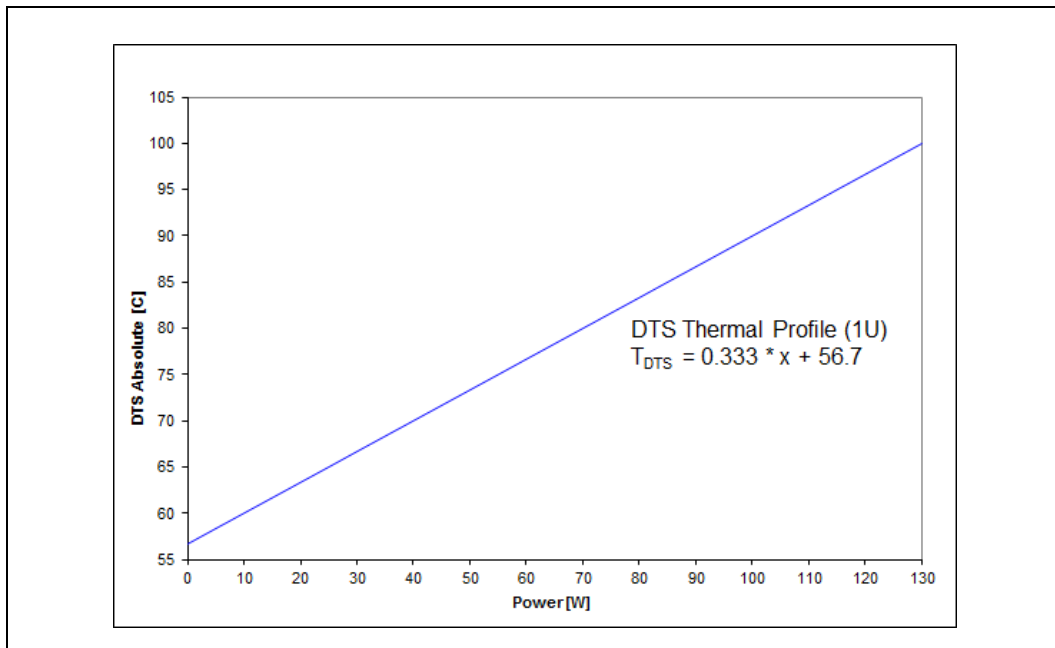
Figure 5-5. Tcase: 8/6-Core 130W Thermal Profile 1U



Notes:

1. Please refer to Table 5-7 for discrete points that constitute this thermal profile.
2. Refer to the *Intel® Xeon® Processor E5-1600/E5-2600/E5-4600 Product Families Thermal/Mechanical Design Guide* for system and environmental implementation details.

Figure 5-6. DTS: 8-Core 130W Thermal Profile 1U

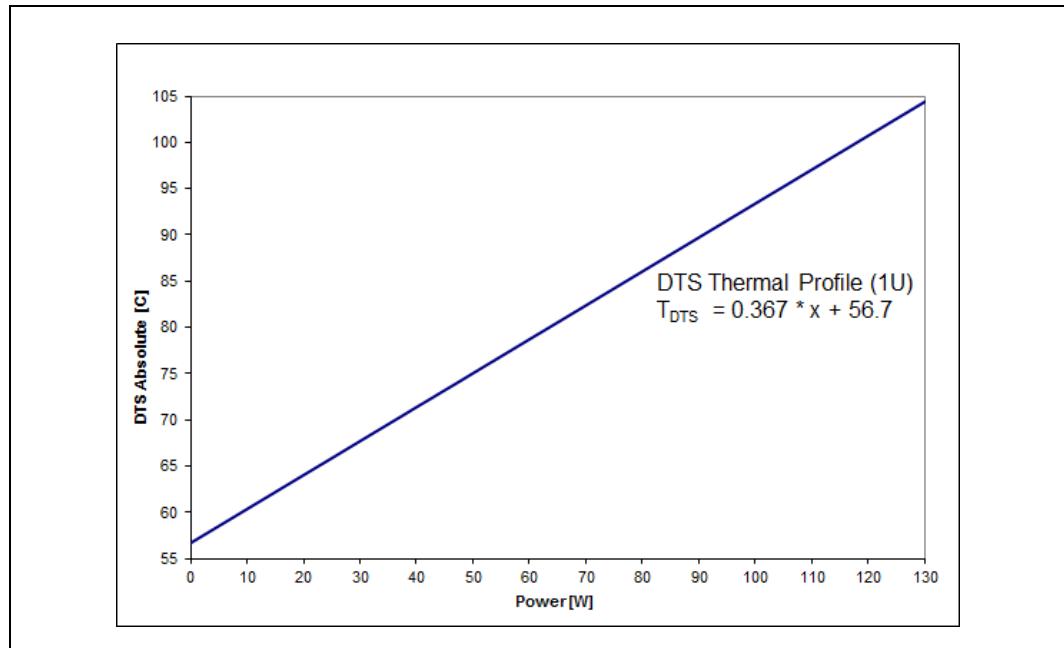


Notes:

1. Some processor units may be tested to lower TDP and the TEMPERATURE_TARGET MSR will be aligned to that lower TDP.
2. Please refer to Table 5-7 for discrete points that constitute the thermal profile.
3. Refer to the *Intel® Xeon® Processor E5-1600/E5-2600/E5-4600 Product Families Thermal/Mechanical Design Guide* for system and environmental implementation details.



Figure 5-7. DTS: 6-Core 130W Thermal Profile 1U



Notes:

1. Some processor units may be tested to lower TDP and the TEMPERATURE_TARGET MSR will be aligned to that lower TDP.
2. Please refer to Table 5-7 for discrete points that constitute the thermal profile.
3. Refer to the *Intel® Xeon® Processor E5-1600/E5-2600/E5-4600 Product Families Thermal/Mechanical Design Guide* for system and environmental implementation details.

Table 5-7. 8/6-Core 130W Thermal Profile Table 1U (Sheet 1 of 2)

Power (W)	Maximum T _{CASE} (°C)		Maximum DTS (°C)	
	8/6-core	8-core	8-core	6-Core
0	56.7	56.7	56.7	56.7
5	57.8	58.4	58.4	58.5
10	58.9	60.0	60.0	60.4
15	60.0	61.7	61.7	62.2
20	61.1	63.4	63.4	64.0
25	62.2	65.0	65.0	65.9
30	63.2	66.7	66.7	67.7
35	64.3	68.4	68.4	69.5
40	65.4	70.0	70.0	71.4
45	66.5	71.7	71.7	72.5
50	67.6	73.4	73.4	75.1
55	68.7	75.0	75.0	76.9
60	69.8	76.7	76.7	78.7
65	70.9	78.3	78.3	80.6
70	72.0	80.0	80.0	82.4
75	73.1	81.7	81.7	84.2
80	74.1	83.3	83.3	86.1
85	75.2	85.0	85.0	87.9
90	76.3	86.7	86.7	89.7
95	77.4	88.3	88.3	91.6



Table 5-7. 8/6-Core 130W Thermal Profile Table 1U (Sheet 2 of 2)

Power (W)	Maximum T _{CASE} (°C)	Maximum DTS (°C)	
	8/6-core	8-core	6-Core
100	78.5	90.0	93.4
105	79.6	91.7	95.2
110	80.7	93.3	97.1
115	81.8	95.0	98.9
120	82.9	96.7	100.7
125	84.0	98.3	102.6
130	85.0	100.0	104.4

5.1.3.4 6-Core 130W 1S WS Thermal Specifications

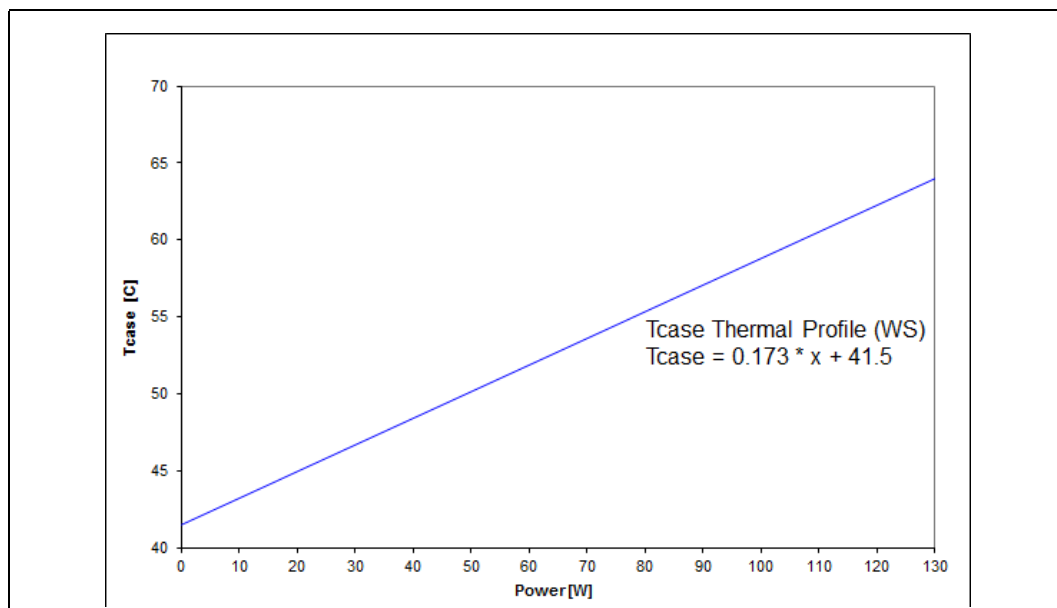
Table 5-8. Tcase: 6-Core 130W 1S WS Thermal Specifications

Core Frequency	Thermal Design Power (W)	Minimum T _{CASE} (°C)	Maximum T _{CASE} (°C)	Notes
Launch to FMB	130	5	See Figure 5-8 and Table 5-9	1, 2, 3, 4, 5

Notes:

1. These values are specified at V_{CC_MAX} for all processor frequencies. Systems must be designed to ensure the processor is not to be subjected to any static V_{CC} and I_{CC} combination wherein V_{CC} exceeds V_{CC_MAX} at specified ICC. Please refer to the electrical loadline specifications in Section 7.8.1.
2. Thermal Design Power (TDP) should be used for processor thermal solution design targets. TDP is not the maximum power that the processor can dissipate. TDP is measured at maximum T_{CASE}.
3. These specifications are based on final silicon characterization.
4. Power specifications are defined at all VIDs found in Table 7-3. The processor may be delivered under multiple VIDs for each frequency.
5. FMB, or Flexible Motherboard, guidelines provide a design target for meeting all planned processor frequency requirements.

Figure 5-8. Tcase: 6-Core 130W 1S WS Thermal Profile

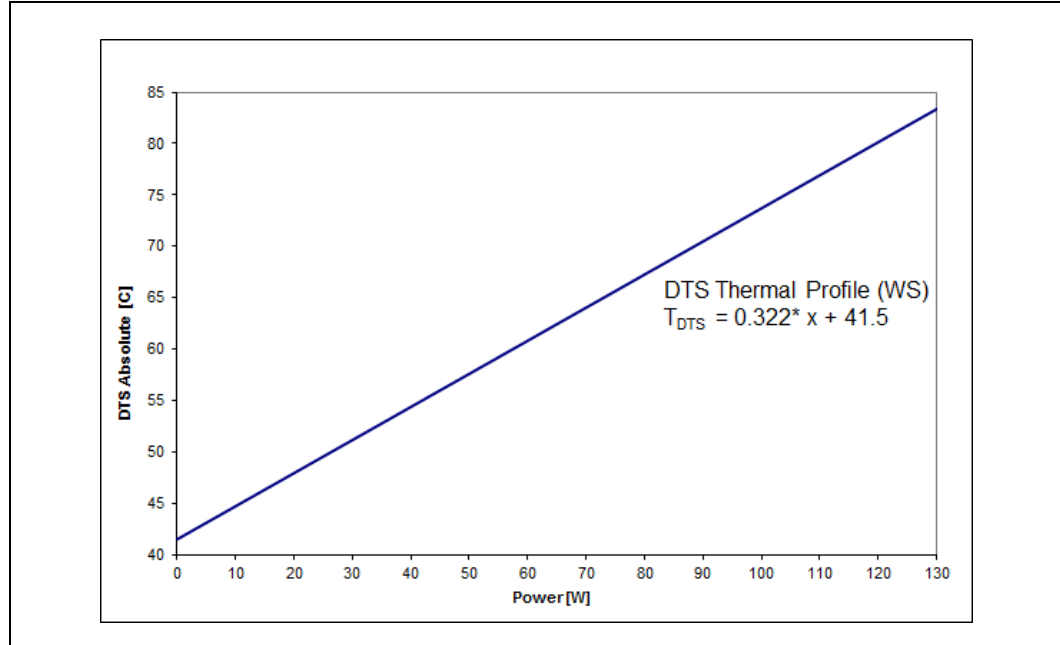




Notes:

1. This Thermal Profile is representative of a volumetrically unconstrained platform. Please refer to Table 5-9 for discrete points that constitute the thermal profile.
2. Implementation of this Thermal Profile should result in virtually no TCC activation. Refer to the *Intel® Xeon® Processor E5-1600/E5-2600/E5-4600 Product Families Thermal/Mechanical Design Guide* for system and environmental implementation details.

Figure 5-9. DTS: 6-Core 130W 1S WS Thermal Profile



Notes:

1. Some processor units may be tested to lower TDP and the TEMPERATURE_TARGET MSR will be aligned to that lower TDP.
2. This Thermal Profile is representative of a volumetrically constrained platform. Please refer to Table 5-9 for discrete points that constitute this thermal profile.
3. Refer to the *Intel® Xeon® Processor E5-1600/E5-2600/E5-4600 Product Families Thermal/Mechanical Design Guide* for system and environmental implementation details.

Table 5-9. 6-Core 130W 1S WS Thermal Profile Table (Sheet 1 of 2)

Power (W)	Maximum T _{CASE} (°C)	Maximum DTS (°C)
0	41.5	41.5
5	42.4	43.1
10	43.2	44.7
15	44.1	46.3
20	45.0	47.9
25	45.8	49.6
30	46.7	51.2
35	47.6	52.8
40	48.4	54.4
45	49.3	55.3
50	50.2	57.6
55	51.0	59.2
60	51.9	60.8
65	52.7	62.4
70	53.6	64.0
75	54.5	65.7
80	55.3	67.3



Table 5-9. 6-Core 130W 1S WS Thermal Profile Table (Sheet 2 of 2)

Power (W)	Maximum T _{CASE} (°C)	Maximum DTS (°C)
85	56.2	68.9
90	57.1	70.5
95	57.9	72.1
100	58.8	73.7
105	59.7	75.3
110	60.5	76.9
115	61.4	78.5
120	62.3	80.1
125	63.1	81.8
130	64.0	83.4

5.1.3.5 8-Core 115W Thermal Specifications

Table 5-10. Tcase: 8-Core 115W Thermal Specifications 1U

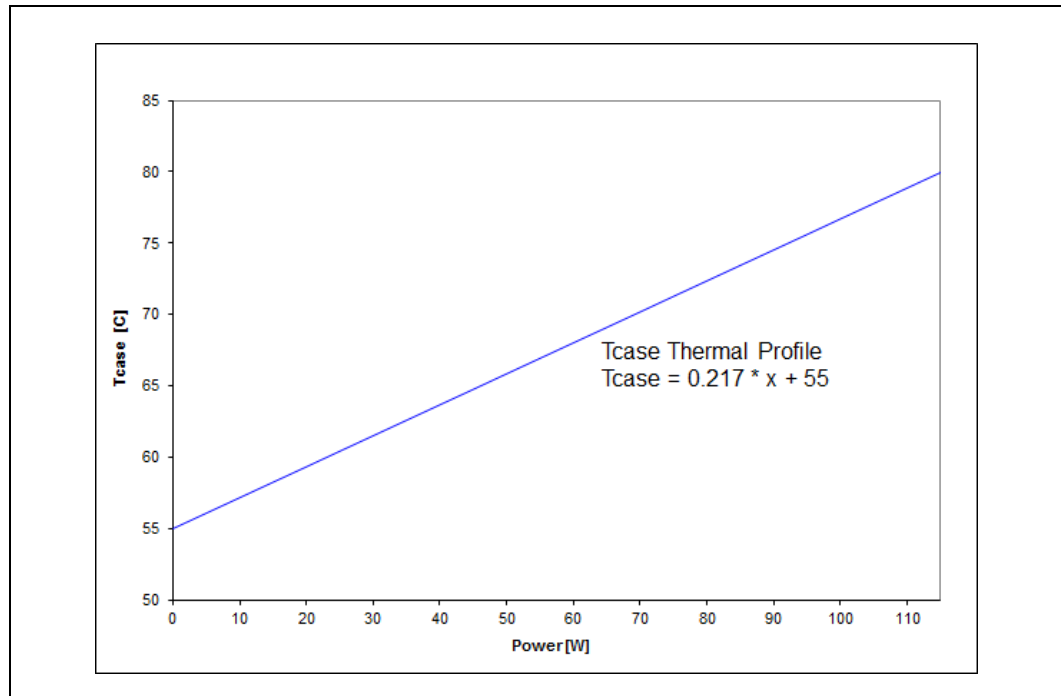
Core Frequency	Thermal Design Power (W)	Minimum T _{CASE} (°C)	Maximum T _{CASE} (°C)	Notes
Launch to FMB	115	5	See Figure 5-10 and Table 5-11	1, 2, 3, 4, 5

Notes:

1. These values are specified at V_{CC_MAX} for all processor frequencies. Systems must be designed to ensure the processor is not to be subjected to any static V_{CC} and I_{CC} combination wherein V_{CC} exceeds V_{CC_MAX} at specified ICC. Please refer to the electrical loadline specifications in Section 7.8.1.
2. Thermal Design Power (TDP) should be used for processor thermal solution design targets. TDP is not the maximum power that the processor can dissipate. TDP is measured at maximum T_{CASE}.
3. These specifications are based on final silicon characterization.
4. Power specifications are defined at all VIDs found in Table 7-3. The processor may be delivered under multiple VIDs for each frequency.
5. FMB, or Flexible Motherboard, guidelines provide a design target for meeting all planned processor frequency requirements.



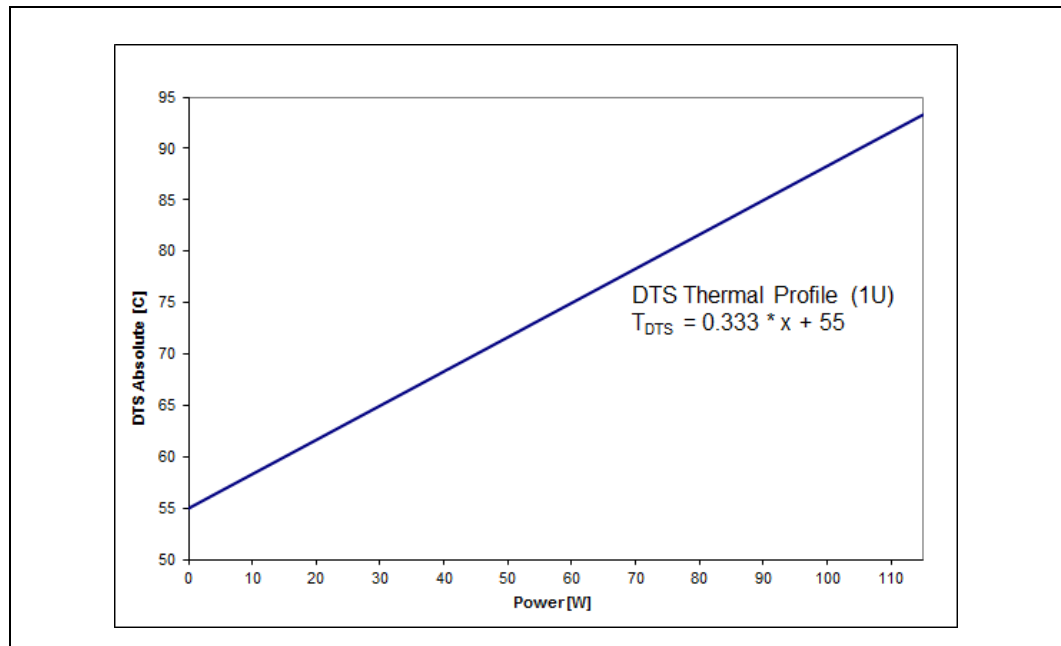
Figure 5-10. Tcase: 8-Core 115W Thermal Profile 1U



Notes:

1. Please refer to [Table 5-11](#) for discrete points that constitute the thermal profile.
2. Implementation of this Thermal Profile should result in virtually no TCC activation. Refer to the *Intel® Xeon® Processor E5-1600/E5-2600/E5-4600 Product Families Thermal/Mechanical Design Guide* for system and environmental implementation details.

Figure 5-11. DTS: 8-Core 115W Thermal Profile 1U



Notes:

1. Some processor units may be tested to lower TDP and the TEMPERATURE_TARGET MSR will be aligned to that lower TDP.
2. Please refer to [Table 5-11](#) for discrete points that constitute this thermal profile.



- Refer to the *Intel® Xeon® Processor E5-1600/E5-2600/E5-4600 Product Families Thermal/Mechanical Design Guide* for system and environmental implementation details.

Table 5-11. 8-Core 115W Thermal Profile Table 1U

Power (W)	Maximum T _{CASE} (°C)	Maximum DTS (°C)
0	55.0	55.0
5	56.1	56.7
10	57.2	58.3
15	58.3	60.0
20	59.3	61.7
25	60.4	63.3
30	61.5	65.0
35	62.6	66.7
40	63.7	68.3
45	64.8	69.3
50	65.9	71.7
55	66.9	73.3
60	68.0	75.0
65	69.1	76.6
70	70.2	78.3
75	71.3	80.0
80	72.4	81.6
85	73.4	83.3
90	74.5	85.0
95	75.6	86.6
100	76.7	88.3
105	77.8	90.0
110	78.9	91.6
115	80.0	93.3

5.1.3.6 8/6-Core 95W Thermal Specifications

Table 5-12. Tcase: 8/6-Core 95W Thermal Specifications, Workstation/Server Platform

Core Frequency	Thermal Design Power (W)	Minimum T _{CASE} (°C)	Maximum T _{CASE} (°C)	Notes
Launch to FMB	95	5	See Figure 5-12 and Table 5-13	1, 2, 3, 4, 5

Notes:

- These values are specified at V_{CC_MAX} for all processor frequencies. Systems must be designed to ensure the processor is not to be subjected to any static V_{CC} and I_{CC} combination wherein V_{CC} exceeds V_{CC_MAX} at specified ICC. Please refer to the electrical loadline specifications in [Section 7.8.1](#).
- Thermal Design Power (TDP) should be used for processor thermal solution design targets. TDP is not the maximum power that the processor can dissipate. TDP is measured at maximum T_{CASE}.
- These specifications are based on final silicon characterization.
- Power specifications are defined at all VIDs found in [Table 7-3](#). The processor may be delivered under multiple VIDs for each frequency.
- FMB, or Flexible Motherboard, guidelines provide a design target for meeting all planned processor frequency requirements.

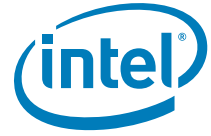
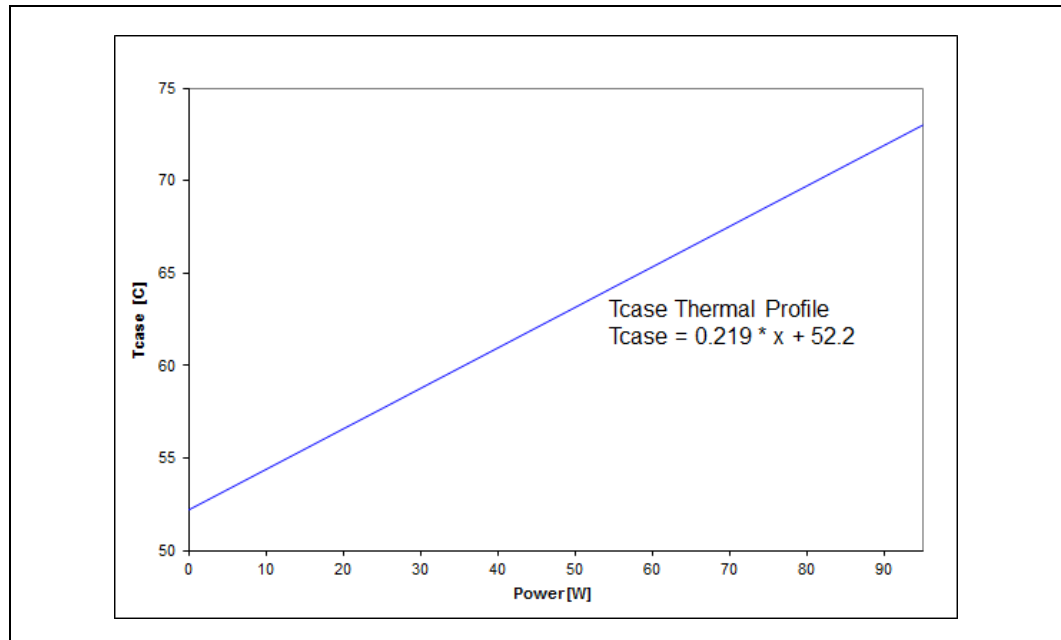


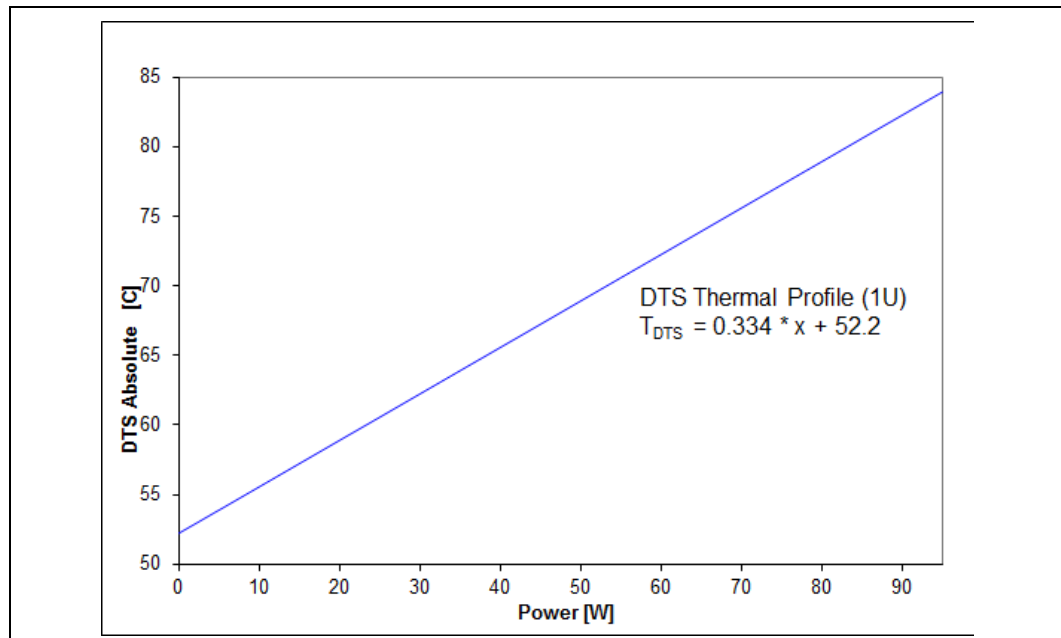
Figure 5-12. Tcase: 8/6-Core 95W Thermal Profile 1U



Notes:

1. Please refer to [Table 5-13](#) for discrete points that constitute this thermal profile.
2. Refer to the *Intel® Xeon® Processor E5-1600/E5-2600/E5-4600 Product Families Thermal/Mechanical Design Guide* for system and environmental implementation details.

Figure 5-13. DTS: 8-Core 95W Thermal Profile 1U

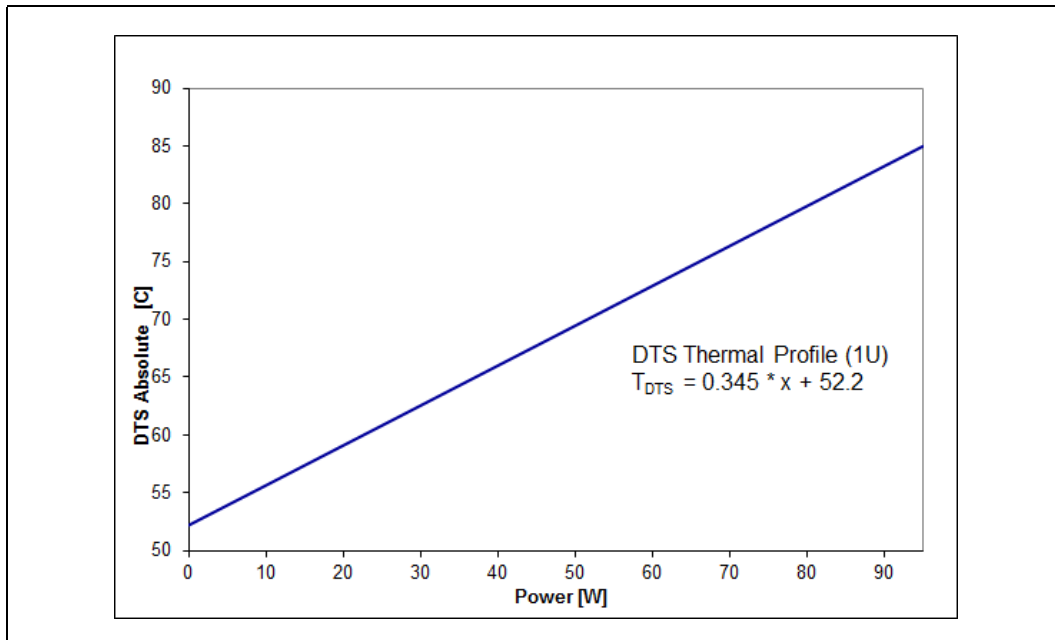


Notes:

1. Some processor units may be tested to lower TDP and the TEMPERATURE_TARGET MSR will be aligned to that lower TDP.
2. Please refer to [Table 5-13](#) for discrete points that constitute this thermal profile.
3. Refer to the *Intel® Xeon® Processor E5-1600/E5-2600/E5-4600 Product Families Thermal/Mechanical Design Guide* for system and environmental implementation details.



Figure 5-14. DTS: 6-Core 95W Thermal Profile 1U



Notes:

1. Some processor units may be tested to lower TDP and the TEMPERATURE_TARGET MSR will be aligned to that lower TDP.
2. Please refer to Table 5-13 for discrete points that constitute this thermal profile.
3. Refer to the *Intel® Xeon® Processor E5-1600/E5-2600/E5-4600 Product Families Thermal/Mechanical Design Guide* for system and environmental implementation details.

Table 5-13. 8/6-Core 95W Thermal Profile Table 1U (Sheet 1 of 2)

Power (W)	Maximum T _{CASE} (°C)	Maximum DTS (°C)	
	8/6-core	8-core	6-core
0	52.2	52.2	52.2
5	53.3	53.9	53.9
10	54.4	55.5	55.7
15	55.5	57.2	57.4
20	56.6	58.9	59.1
25	57.7	60.6	60.8
30	58.8	62.2	62.6
35	59.9	63.9	64.3
40	61.0	65.6	66.0
45	62.1	67.2	67.7
50	63.2	68.9	69.5
55	64.2	70.6	71.2
60	65.3	72.2	72.9
65	66.4	73.9	74.6
70	67.5	75.6	76.4
75	68.6	77.3	78.1
80	69.7	78.9	79.8



Table 5-13. 8/6-Core 95W Thermal Profile Table 1U (Sheet 2 of 2)

Power (W)	Maximum T _{CASE} (°C)	Maximum DTS (°C)	
	8/6-core	8-core	6-core
85	70.8	80.6	81.5
90	71.9	82.3	83.3
95	73.0	83.9	85.0

5.1.3.7 8-Core 70W Thermal Specifications

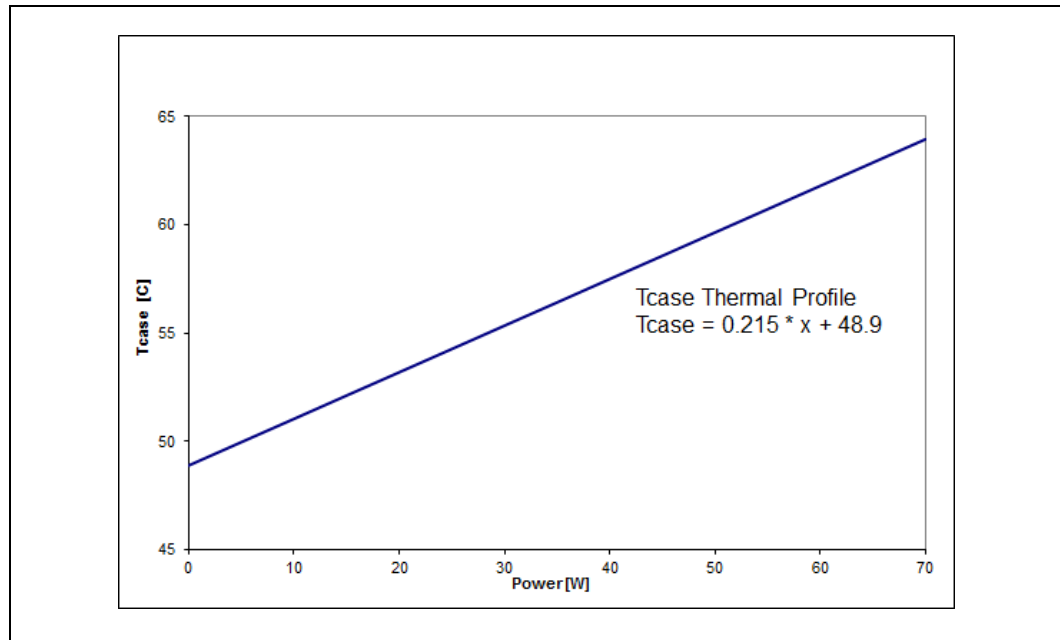
Table 5-14. Tcase: 8-Core 70W Thermal Specifications 1U

Core Frequency	Thermal Design Power (W)	Minimum T _{CASE} (°C)	Maximum T _{CASE} (°C)	Notes
Launch to FMB	70	5	See Figure 5-15 and Table 5-15	1, 2, 3, 4, 5

Notes:

1. These values are specified at V_{CC_MAX} for all processor frequencies. Systems must be designed to ensure the processor is not to be subjected to any static V_{CC} and I_{CC} combination wherein V_{CC} exceeds V_{CC_MAX} at specified ICC. Please refer to the electrical loadline specifications in Section 7.8.1.
2. Thermal Design Power (TDP) should be used for processor thermal solution design targets. TDP is not the maximum power that the processor can dissipate. TDP is measured at maximum T_{CASE}.
3. These specifications are based on final silicon characterization.
4. Power specifications are defined at all VIDs found in Table 7-3. The processor may be delivered under multiple VIDs for each frequency.
5. FMB, or Flexible Motherboard, guidelines provide a design target for meeting all planned processor frequency requirements.

Figure 5-15. Tcase: 8-Core 70W Thermal Profile 1U

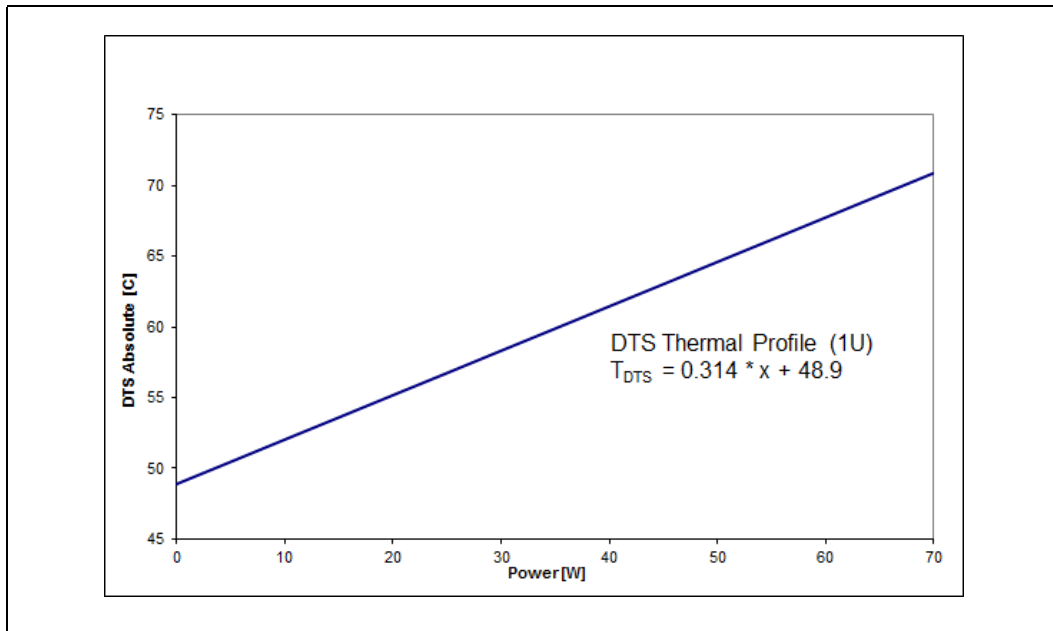


Notes:

1. Please refer to Table 5-15 for discrete points that constitute the thermal profile.
2. Implementation of this Thermal Profile should result in virtually no TCC activation. Refer to the Intel® Xeon® Processor E5-1600/E5-2600/E5-4600 Product Families Thermal/Mechanical Design Guide for system and environmental implementation details.



Figure 5-16. DTS: 8-Core 70W Thermal Profile 1U



Notes:

1. Some processor units may be tested to lower TDP and the TEMPERATURE_TARGET MSR will be aligned to that lower TDP.
2. Please refer to Table 5-15 for discrete points that constitute the thermal profile.
3. Implementation of this Thermal Profile should result in virtually no TCC activation. Refer to the *Intel® Xeon® Processor E5-1600/E5-2600/E5-4600 Product Families Thermal/Mechanical Design Guide* for system and environmental implementation details.

Table 5-15. 8-Core 70W Thermal Profile Table 1U

Power (W)	Maximum T _{CASE} (°C)	Maximum DTS (°C)
0	48.9	48.9
5	50.0	50.5
10	51.1	52.0
15	52.1	53.6
20	53.2	55.2
25	54.3	56.8
30	55.4	58.3
35	56.4	59.9
40	57.5	61.5
45	58.6	63.0
50	59.7	64.6
55	60.7	66.2
60	61.8	67.7
65	62.9	69.3
70	64.0	70.9



5.1.3.8 6-Core 60W Thermal Specifications

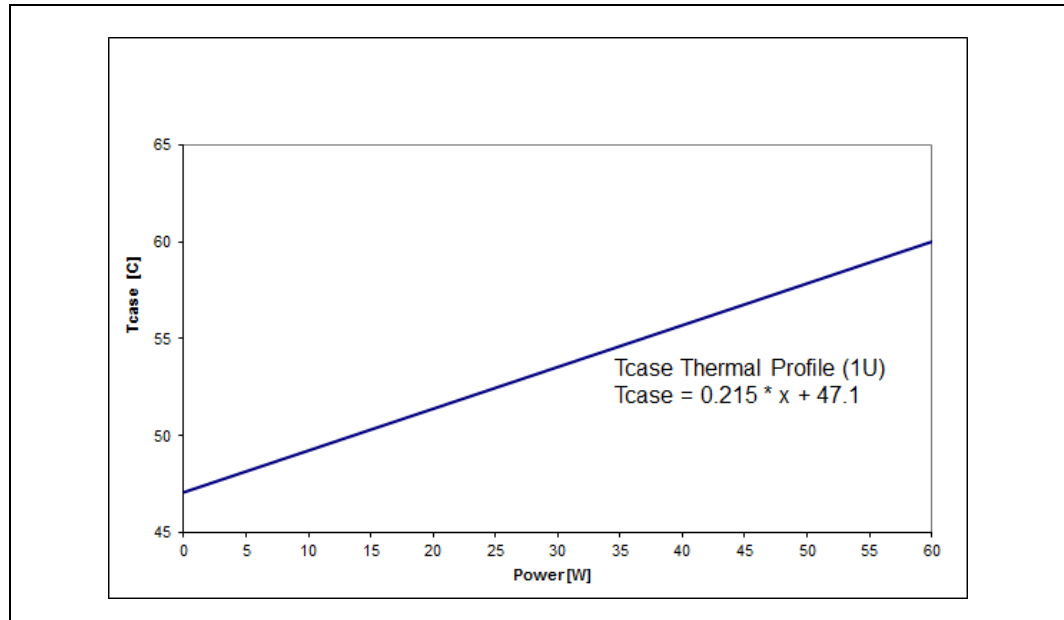
Table 5-16. Tcase: 6-Core 60W Thermal Specifications 1U

Core Frequency	Thermal Design Power (W)	Minimum T _{CASE} (°C)	Maximum T _{CASE} (°C)	Notes
Launch to FMB	60	5	See Figure 5-17 and Table 5-17	1, 2, 3, 4, 5

Notes:

1. These values are specified at V_{CC_MAX} for all processor frequencies. Systems must be designed to ensure the processor is not to be subjected to any static V_{CC} and I_{CC} combination wherein V_{CC} exceeds V_{CC_MAX} at specified ICC. Please refer to the electrical loadline specifications in Section 7.8.1.
2. Thermal Design Power (TDP) should be used for processor thermal solution design targets. TDP is not the maximum power that the processor can dissipate. TDP is measured at maximum T_{CASE}.
3. These specifications are based on final silicon characterization.
4. Power specifications are defined at all VIDs found in Table 7-3. The processor may be delivered under multiple VIDs for each frequency.
5. FMB, or Flexible Motherboard, guidelines provide a design target for meeting all planned processor frequency requirements.

Figure 5-17. Tcase: 6-Core 60W Thermal Profile 1U

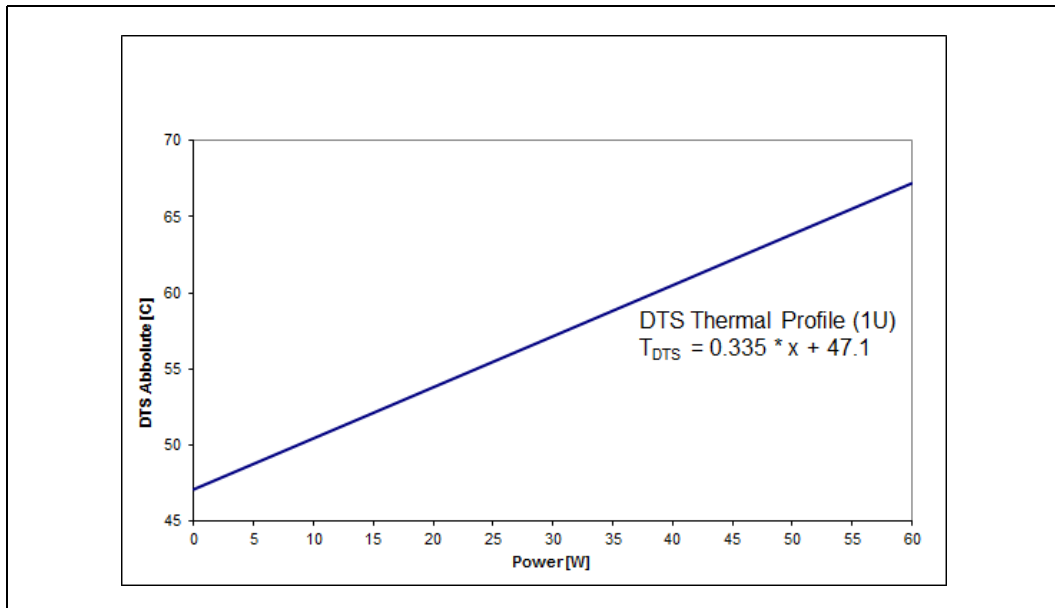


Notes:

1. Please refer to Table 5-17 for discrete points that constitute the thermal profile.
2. Implementation of this Thermal Profile should result in virtually no TCC activation. Refer to the Intel® Xeon® Processor E5-1600/E5-2600/E5-4600 Product Families Thermal/Mechanical Design Guide for system and environmental implementation details.



Figure 5-18. DTS: 6-Core 60W Thermal Profile 1U



Notes:

1. Some processor units may be tested to lower TDP and the TEMPERATURE_TARGET MSR will be aligned to that lower TDP.
2. Please refer to Table 5-17 for discrete points that constitute the thermal profile.
3. Implementation of this Thermal Profile should result in virtually no TCC activation. Refer to the *Intel® Xeon® Processor E5-1600/E5-2600/E5-4600 Product Families Thermal/Mechanical Design Guide* for system and environmental implementation details.

Table 5-17. 6-Core 60W Thermal Profile Table 1U

Power (W)	Maximum T _{CASE} (°C)	Maximum DTS (°C)
0	47.1	47.1
5	48.2	48.8
10	49.3	50.5
15	50.3	52.1
20	51.4	53.8
25	52.5	55.5
30	53.6	57.2
35	54.6	58.8
40	55.7	60.5
45	56.8	62.2
50	57.9	63.9
55	58.9	65.5
60	60.0	67.2



5.1.3.9 4-Core 130W Thermal Specifications

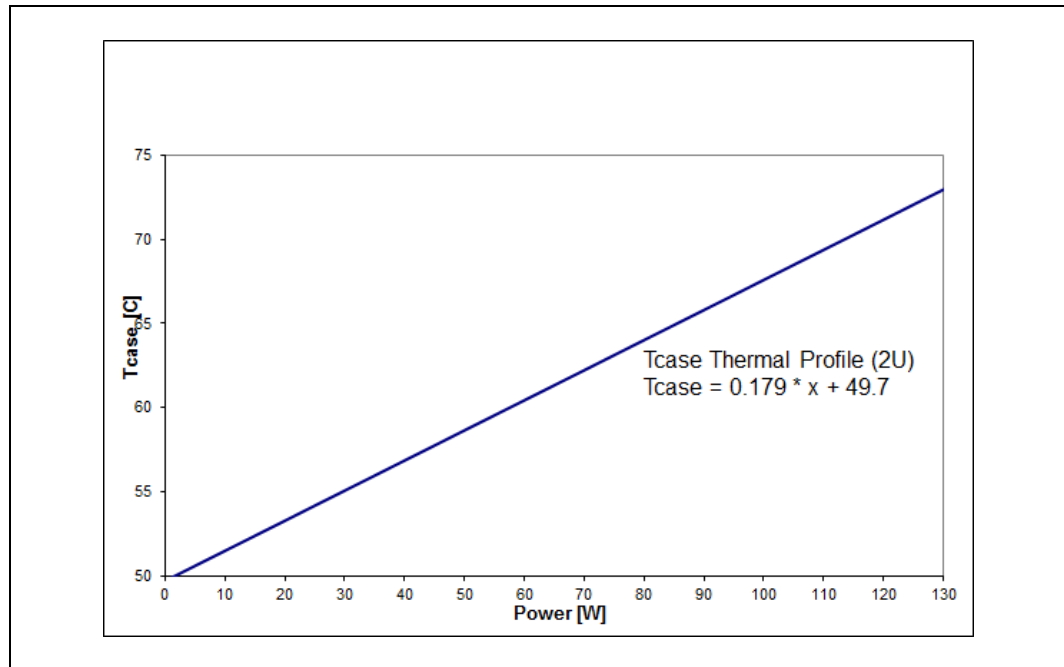
Table 5-18. Tcase: 4-Core 130W Thermal Specifications 2U

Core Frequency	Thermal Design Power (W)	Minimum T _{CASE} (°C)	Maximum T _{CASE} (°C)	Notes
Launch to FMB	130	5	See Figure 5-19 and Table 5-19	1, 2, 3, 4, 5

Notes:

1. These values are specified at V_{CC_MAX} for all processor frequencies. Systems must be designed to ensure the processor is not to be subjected to any static V_{CC} and I_{CC} combination wherein V_{CC} exceeds V_{CC_MAX} at specified ICC. Please refer to the electrical loadline specifications in Section 7.8.1.
2. Thermal Design Power (TDP) should be used for processor thermal solution design targets. TDP is not the maximum power that the processor can dissipate. TDP is measured at maximum T_{CASE}.
3. These specifications are based on final silicon characterization.
4. Power specifications are defined at all VIDs found in Table 7-3. The processor may be delivered under multiple VIDs for each frequency.
5. FMB, or Flexible Motherboard, guidelines provide a design target for meeting all planned processor frequency requirements.

Figure 5-19. Tcase: 4-Core 130W Thermal Profile 2U

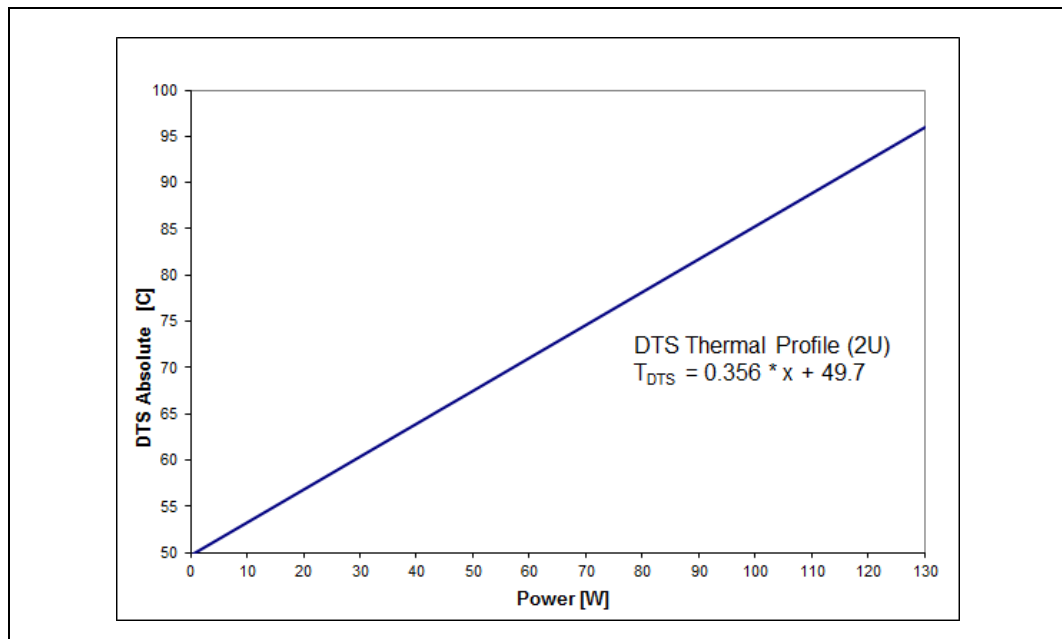


Notes:

1. This Thermal Profile is representative of a volumetrically unconstrained platform. Please refer to Table 5-19 for discrete points that constitute the thermal profile.
2. Implementation of this Thermal Profile should result in virtually no TCC activation. Refer to the Intel® Xeon® Processor E5-1600/E5-2600/E5-4600 Product Families Thermal/Mechanical Design Guide for system and environmental implementation details.



Figure 5-20. DTS: 4-Core 130W Thermal Profile 2U



Notes:

1. Some of the processor units may be tested to lower TDP and the TEMPERATURE_TARGET MSR will be aligned to that lower TDP.
2. This Thermal Profile is representative of a volumetrically unconstrained platform. Please refer to [Table 5-19](#) for discrete points that constitute the thermal profile.
3. Implementation of this Thermal Profile should result in virtually no TCC activation. Refer to the *Intel® Xeon® Processor E5-1600/E5-2600/E5-4600 Product Families Thermal/Mechanical Design Guide* for system and environmental implementation details.

Table 5-19. 4-Core 130W Thermal Profile Table 2U (Sheet 1 of 2)

Power (W)	Maximum T _{CASE} (°C)	Maximum DTS (°C)
0	49.7	49.7
5	50.6	51.5
10	51.5	53.3
15	52.4	55.0
20	53.3	56.8
25	54.2	58.6
30	55.1	60.4
35	56.0	62.2
40	56.9	63.9
45	57.8	65.0
50	58.7	67.5
55	59.5	69.3
60	60.4	71.1
65	61.3	72.8
70	62.2	74.6
75	63.1	76.4
80	64.0	78.2



Table 5-19. 4-Core 130W Thermal Profile Table 2U (Sheet 2 of 2)

Power (W)	Maximum T _{CASE} (°C)	Maximum DTS (°C)
85	64.9	80.0
90	65.8	81.7
95	66.7	83.5
100	67.6	85.3
105	68.5	87.1
110	69.4	88.9
115	70.3	90.6
120	71.2	92.4
125	72.1	94.2
130	73.0	96.0

5.1.3.10 4-Core 130W 1S WS Thermal Specifications

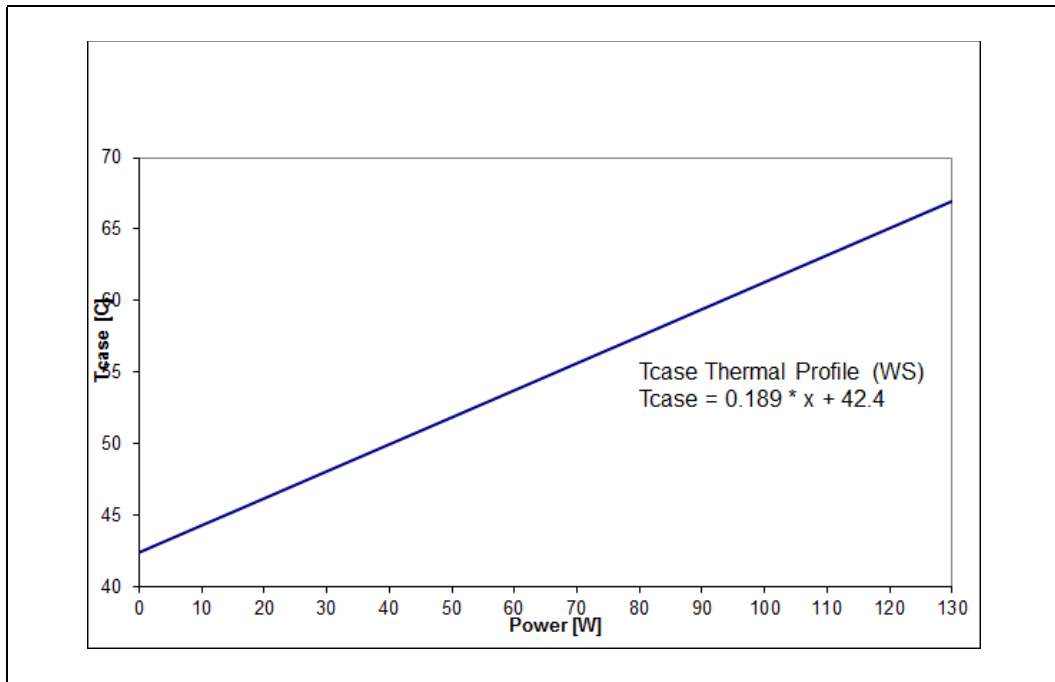
Table 5-20. Tcase: 4-Core 130W 1S WS Thermal Specifications, Workstation/Server Platform

Core Frequency	Thermal Design Power (W)	Minimum T _{CASE} (°C)	Maximum T _{CASE} (°C)	Notes
Launch to FMB	130	5	See Figure 5-21 and Table 5-21	1, 2, 3, 4, 5

Notes:

1. These values are specified at V_{CC_MAX} for all processor frequencies. Systems must be designed to ensure the processor is not to be subjected to any static V_{CC} and I_{CC} combination wherein V_{CC} exceeds V_{CC_MAX} at specified ICC. Please refer to the electrical loadline specifications in Section 7.8.1.
2. Thermal Design Power (TDP) should be used for processor thermal solution design targets. TDP is not the maximum power that the processor can dissipate. TDP is measured at maximum T_{CASE}.
3. These specifications are based on final silicon characterization.
4. Power specifications are defined at all VIDs found in Table 7-3. The processor may be delivered under multiple VIDs for each frequency.
5. FMB, or Flexible Motherboard, guidelines provide a design target for meeting all planned processor frequency requirements.

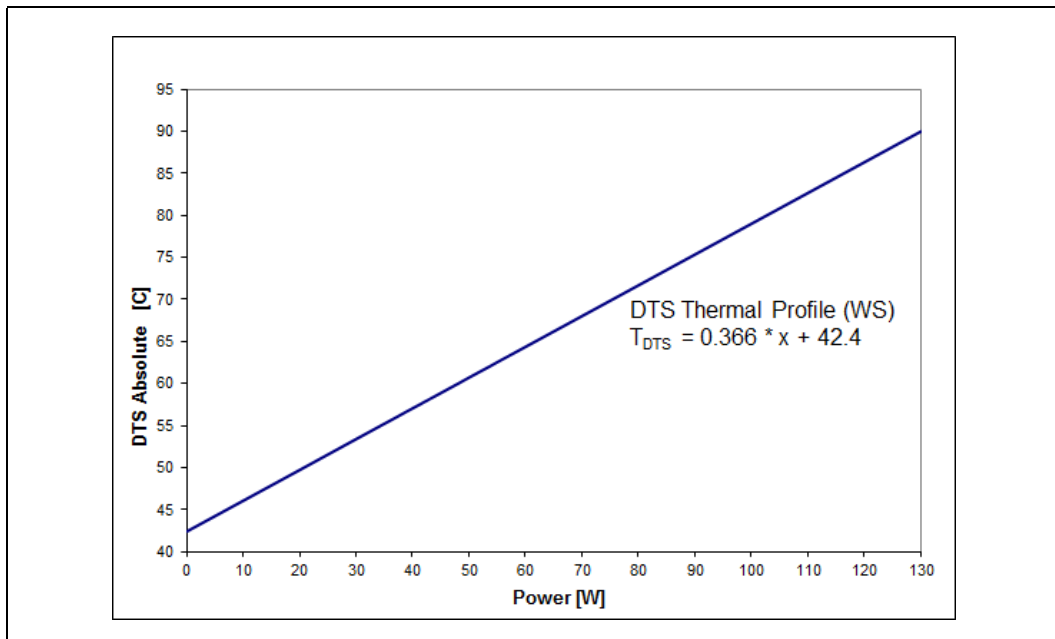
Figure 5-21. Tcase: 4-Core 130W 1S WS Thermal Profile



Notes:

1. This Thermal Profile is representative of a volumetrically constrained platform. Please refer to [Table 5-21](#) for discrete points that constitute this thermal profile.
2. Refer to the *Intel® Xeon® Processor E5-1600/E5-2600/E5-4600 Product Families Thermal/Mechanical Design Guide* for system and environmental implementation details.

Figure 5-22. DTS: 4-Core 130W 1S WS Thermal Profile



Notes:

1. Some processor units may be tested to lower TDP and the TEMPERATURE_TARGET MSR will be aligned to that lower TDP.



2. This Thermal Profile is representative of a volumetrically constrained platform. Please refer to [Table 5-21](#) for discrete points that constitute thermal profile.
3. Refer to the *Intel® Xeon® Processor E5-1600/E5-2600/E5-4600 Product Families Thermal/Mechanical Design Guide* for system and environmental implementation details.

Table 5-21. 4-Core 130W 1S WS Thermal Profile Table

Power (W)	Maximum T _{CASE} (°C)	Maximum DTS (°C)
0	42.4	42.4
5	43.3	44.2
10	44.3	46.1
15	45.2	47.9
20	46.2	49.7
25	47.1	51.6
30	48.1	53.4
35	49.0	55.2
40	50.0	57.0
45	50.9	58.1
50	51.9	60.7
55	52.8	62.5
60	53.7	64.4
65	54.7	66.2
70	55.6	68.0
75	56.6	69.9
80	57.5	71.7
85	58.5	73.5
90	59.4	75.3
95	60.4	77.2
100	61.3	79.0
105	62.2	80.8
110	63.2	82.7
115	64.1	84.5
120	65.1	86.3
125	66.0	88.2
130	67.0	90.0

5.1.3.11 4-Core 95W Thermal Specifications

The 4-Core 95W thermal specifications only applies to the Intel® Xeon® Processor E5-4600 Product Family.

Table 5-22. Tcase: 4-Core 95W Thermal Specifications 1U

Core Frequency	Thermal Design Power (W)	Minimum T _{CASE} (°C)	Maximum T _{CASE} (°C)	Notes
Launch to FMB	95	5	See Figure 5-23 and Table 5-23	1, 2, 3, 4, 5

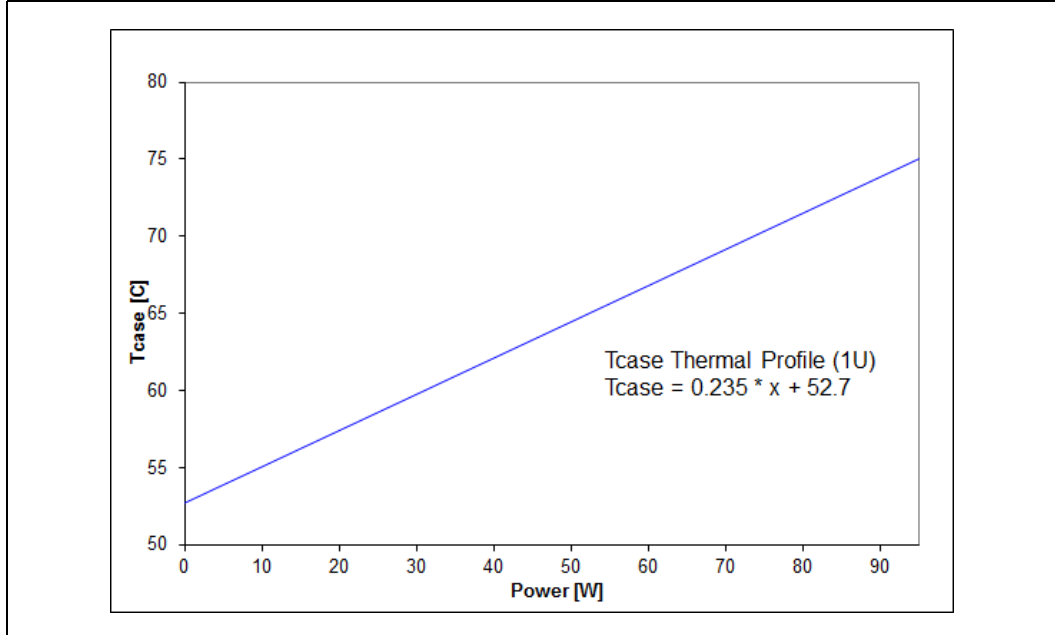
Notes:

1. These values are specified at V_{CC_MAX} for all processor frequencies. Systems must be designed to ensure the processor is not to be subjected to any static V_{CC} and I_{CC} combination wherein V_{CC} exceeds V_{CC_MAX} at specified ICC. Please refer to the electrical loadline specifications in [Section 7.8.1](#).



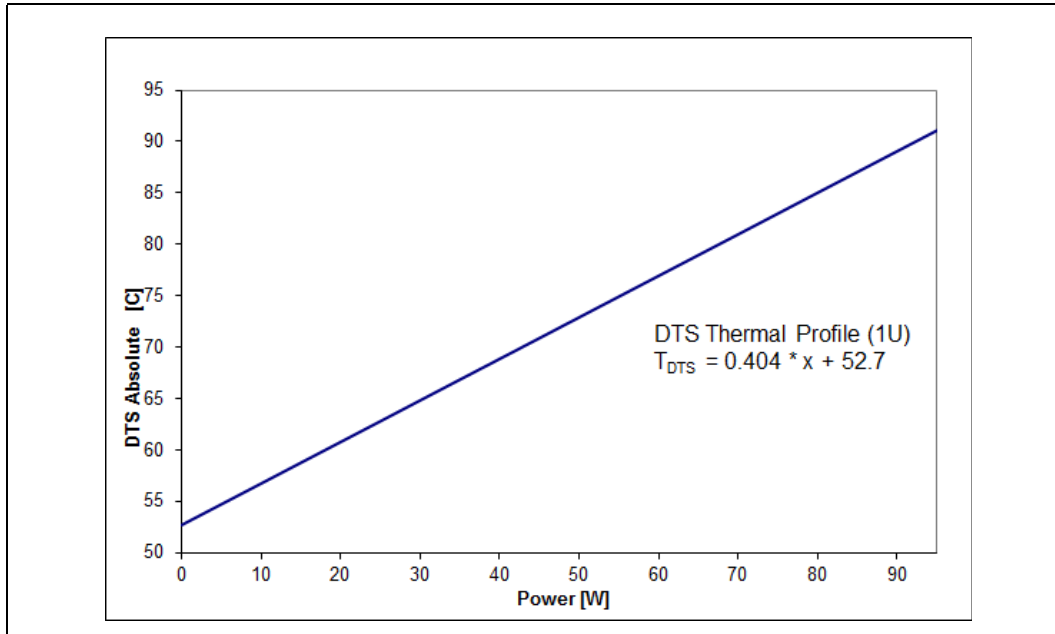
- 2. Thermal Design Power (TDP) should be used for processor thermal solution design targets. TDP is not the maximum power that the processor can dissipate. TDP is measured at maximum T_{CASE}.
- 3. These specifications are based on final silicon characterization.
- 4. Power specifications are defined at all VIDs found in Table 7-3. The processor may be delivered under multiple VIDs for each frequency.
- 5. FMB, or Flexible Motherboard, guidelines provide a design target for meeting all planned processor frequency requirements.

Figure 5-23. Tcase: 4-Core 95W Thermal Profile 1U



- 1. Please refer to Table 5-23 for discrete points that constitute the thermal profile.
- 2. Implementation of this Thermal Profile should result in virtually no TCC activation. Refer to the Intel® Xeon® Processor E5-1600/E5-2600/E5-4600 Product Families Thermal/Mechanical Design Guide for system and environmental implementation details.

Figure 5-24. DTS: 4-Core 95W Thermal Profile 1U





1. Some processor units may be tested to lower TDP and the TEMPERATURE_TARGET MSR will be aligned to that lower TDP.
2. Please refer to [Table 5-23](#) for discrete points that constitute the thermal profile.
3. Implementation of this Thermal Profile should result in virtually no TCC activation. Refer to the *Intel® Xeon® Processor E5-1600/E5-2600/E5-4600 Product Families Thermal/Mechanical Design Guide* for system and environmental implementation details.

Table 5-23. 4-Core 95W Thermal Profile Table 1U

Power (W)	Maximum T _{CASE} (°C) 4-core	Maximum DTS (°C) 4-core
0	52.7	52.7
5	53.9	54.7
10	55.1	56.7
15	56.2	58.8
20	57.4	60.8
25	58.6	62.8
30	59.8	64.8
35	60.9	66.8
40	62.1	68.9
45	63.3	70.1
50	64.5	72.9
55	65.6	74.9
60	66.8	76.9
65	68.0	79.0
70	69.2	81.0
75	70.3	83.0
80	71.5	85.0
85	72.7	87.0
90	73.9	89.1
95	75.0	91.1

5.1.3.12 4/2-Core 80W Thermal Specifications

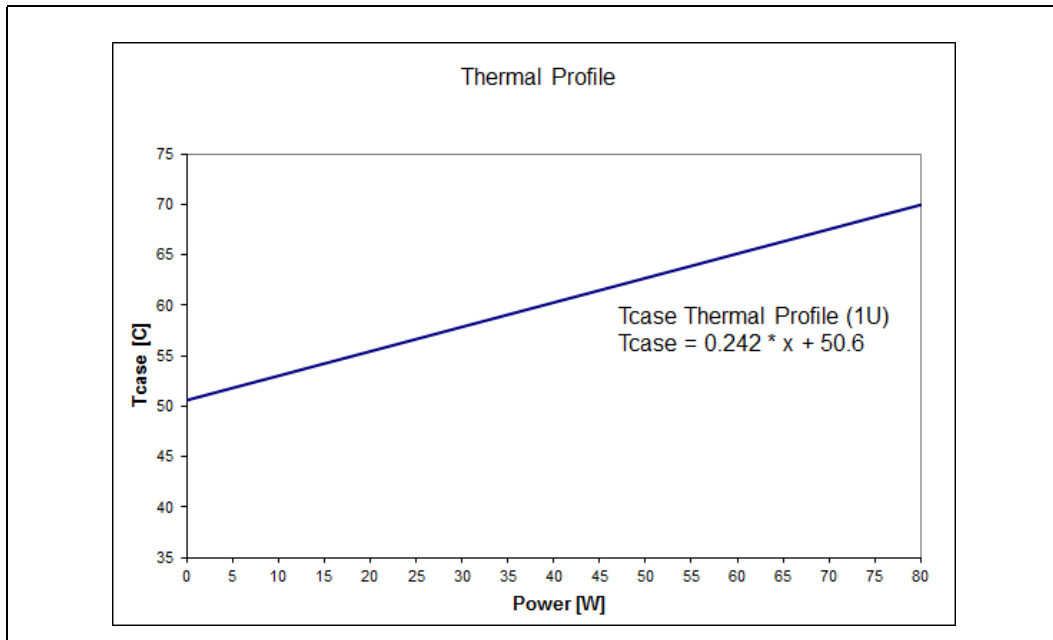
Table 5-24. Tcase: 4/2-Core 80W Thermal Specifications 1U

Core Frequency	Thermal Design Power (W)	Minimum T _{CASE} (°C)	Maximum T _{CASE} (°C)	Notes
Launch to FMB	80	5	See Figure 5-25 and Table 5-25	1, 2, 3, 4, 5

Notes:

1. These values are specified at V_{CC_MAX} for all processor frequencies. Systems must be designed to ensure the processor is not to be subjected to any static V_{CC} and I_{CC} combination wherein V_{CC} exceeds V_{CC_MAX} at specified ICC. Please refer to the electrical loadline specifications in [Section 7.8.1](#).
2. Thermal Design Power (TDP) should be used for processor thermal solution design targets. TDP is not the maximum power that the processor can dissipate. TDP is measured at maximum T_{CASE}.
3. These specifications are based on final silicon characterization.
4. Power specifications are defined at all VIDs found in [Table 7-3](#). The processor may be delivered under multiple VIDs for each frequency.
5. FMB, or Flexible Motherboard, guidelines provide a design target for meeting all planned processor frequency requirements.

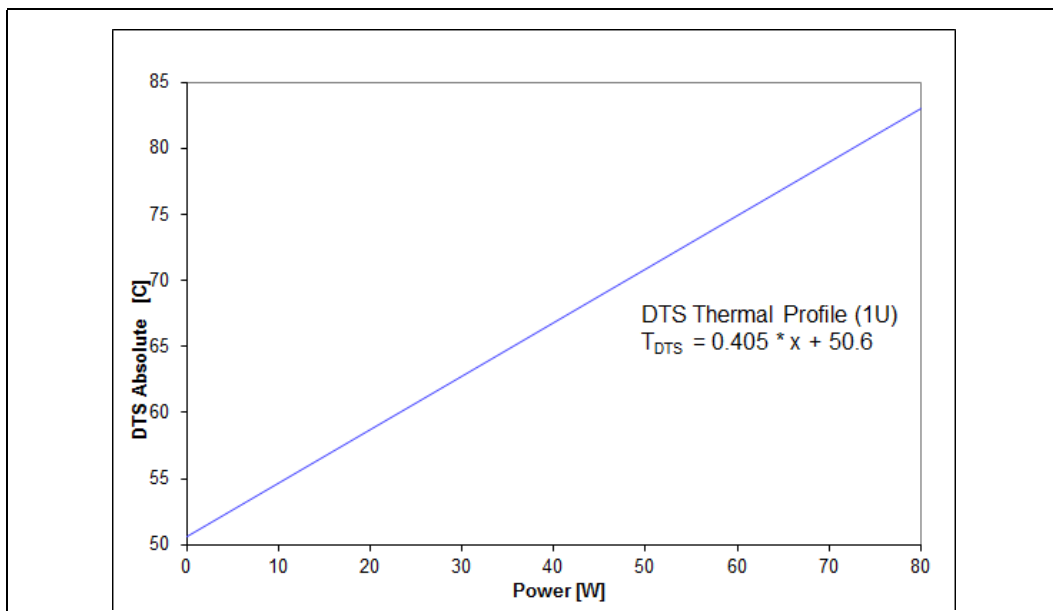
Figure 5-25. Tcase: 4/2-Core 80W Thermal Profile 1U



Notes:

1. Please refer to Table 5-25 for discrete points that constitute the thermal profile.
2. Implementation of this Thermal Profile should result in virtually no TCC activation. Refer to the *Intel® Xeon® Processor E5-1600/E5-2600/E5-4600 Product Families Thermal/Mechanical Design Guide* for system and environmental implementation details.

Figure 5-26. DTS: 4-Core 80W Thermal Profile 1U

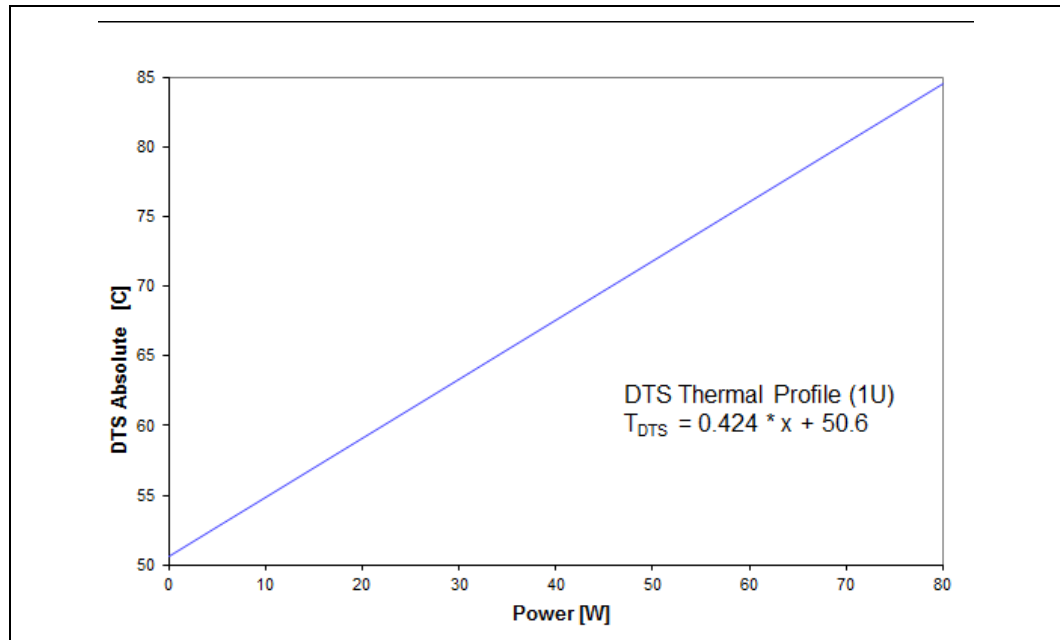


Notes:

1. Some processor units may be tested to lower TDP and the TEMPERATURE_TARGET MSR will be aligned to that lower TDP.
2. Please refer to Table 5-25 for discrete points that constitute the thermal profile.
3. Implementation of this Thermal Profile should result in virtually no TCC activation. Refer to the *Intel® Xeon® Processor E5-1600/E5-2600/E5-4600 Product Families Thermal/Mechanical Design Guide* for system and environmental implementation details.



Figure 5-27. DTS: 2-Core 80W Thermal Profile 1U



Notes:

1. Some processor units may be tested to lower TDP and the TEMPERATURE_TARGET MSR will be aligned to that lower TDP.
2. Please refer to Table 5-25 for discrete points that constitute the thermal profile.
3. Implementation of this Thermal Profile should result in virtually no TCC activation. Refer to the *Intel® Xeon® Processor E5-1600/E5-2600/E5-4600 Product Families Thermal/Mechanical Design Guide* for system and environmental implementation details.

Table 5-25. 4/2-Core 80W Thermal Profile Table 1U (Sheet 1 of 2)

Power (W)	Maximum T _{CASE} (°C)	Maximum DTS (°C)	
	4-core	4-core	2-core
0	50.6	50.6	50.6
5	51.8	52.6	52.7
10	53.0	54.7	54.8
15	54.2	56.7	57.0
20	55.4	58.7	59.1
25	56.7	60.7	61.2
30	57.9	62.8	63.3
35	59.1	64.8	65.4
40	60.3	66.8	67.6
45	61.5	68.8	69.7
50	62.7	70.9	71.8
55	63.9	72.9	73.9
60	65.1	74.9	76.0
65	66.3	76.9	78.2
70	67.5	79.0	80.3



Table 5-25. 4/2-Core 80W Thermal Profile Table 1U (Sheet 2 of 2)

Power (W)	Maximum T _{CASE} (°C)	Maximum DTS (°C)	
	4-core	4-core	2-core
75	68.8	81.0	82.4
80	70.0	83.0	84.5

5.1.4 Embedded Server Processor Thermal Profiles

Embedded server SKU's target operation at higher case temperatures and/or NEBS thermal profiles for embedded communications server form factors. The thermal profiles in this section pertain only to those specific SKU's. Network Equipment Building System (NEBS) is the most common set of environmental design guidelines applied to telecommunications equipment in the United States.

Digital Thermal Sensor (DTS) based thermal profiles are also provided for each Embedded server SKU. The thermal solution is expected to be developed in accordance with the Tcase thermal profile. Operational compliance monitoring of thermal specifications and fan speed modulation may be done via the DTS based thermal profile. The slope of a DTS profile assumes full fan speed which is not required over much of the power range. At most power levels on embedded SKU's, temperatures of the nominal profile are less than Tcontrol as indicated by the blue shaded region in each DTS profile graph. As a further simplification, operation at DTS temperatures up to Tcontrol is permitted at all power levels. Compliance to the DTS profile is required for any temperatures exceeding Tcontrol.

Table 5-26. Embedded Server Processor Elevated Tcase SKU Summary Table

TDP SKU	Tcase Spec	DTS Spec
LV95W-8C (8-core)	Figure 5-28	Figure 5-29
LV70W-8C (8-core)	Figure 5-30	Figure 5-31

5.1.4.1 8-Core LV95W Thermal Specifications

Table 5-27. Tcase: 8-Core LV95W Thermal Specifications, Embedded Server SKU

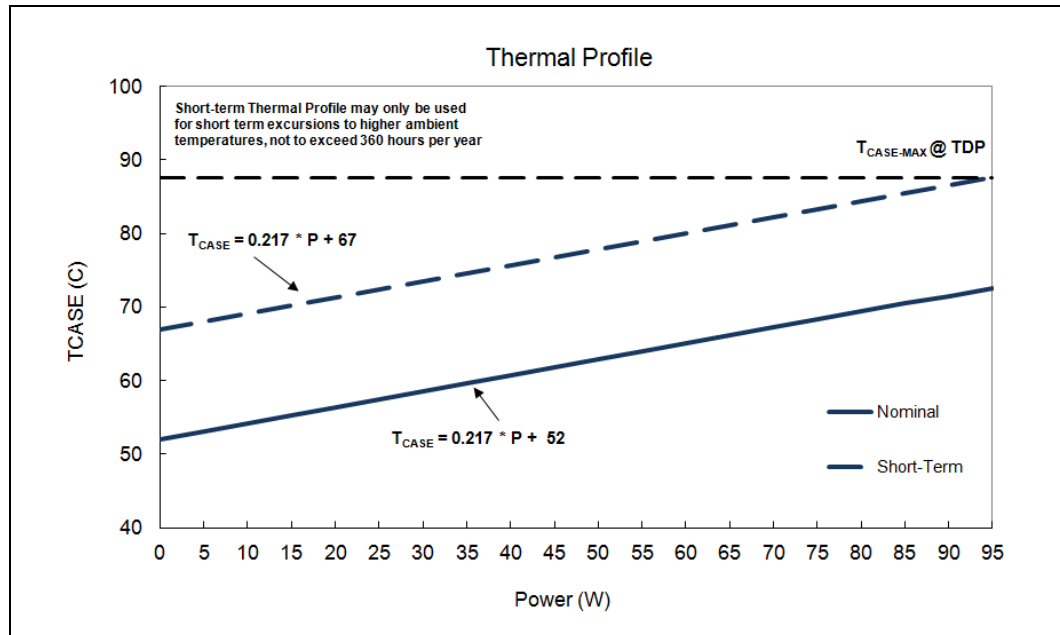
Core Frequency	Thermal Design Power (W)	Minimum T _{CASE} (°C)	Maximum T _{CASE} (°C)	Notes
Launch to FMB	95	5	See Figure 5-28 and Table 5-28	1, 2, 3, 4, 5

Notes:

1. These values are specified at V_{CC_MAX} for all processor frequencies. Systems must be designed to ensure the processor is not to be subjected to any static V_{CC} and I_{CC} combination wherein V_{CC} exceeds V_{CC_MAX} at specified ICC. Please refer to the electrical loadline specifications in Section 7.8.1.
2. Thermal Design Power (TDP) should be used for processor thermal solution design targets. TDP is not the maximum power that the processor can dissipate. TDP is measured at maximum T_{CASE}.
3. These specifications are based on final silicon characterization.
4. Power specifications are defined at all VIDs found in Table 7-3. The processor may be delivered under multiple VIDs for each frequency.
5. FMB, or Flexible Motherboard, guidelines provide a design target for meeting all planned processor frequency requirements.



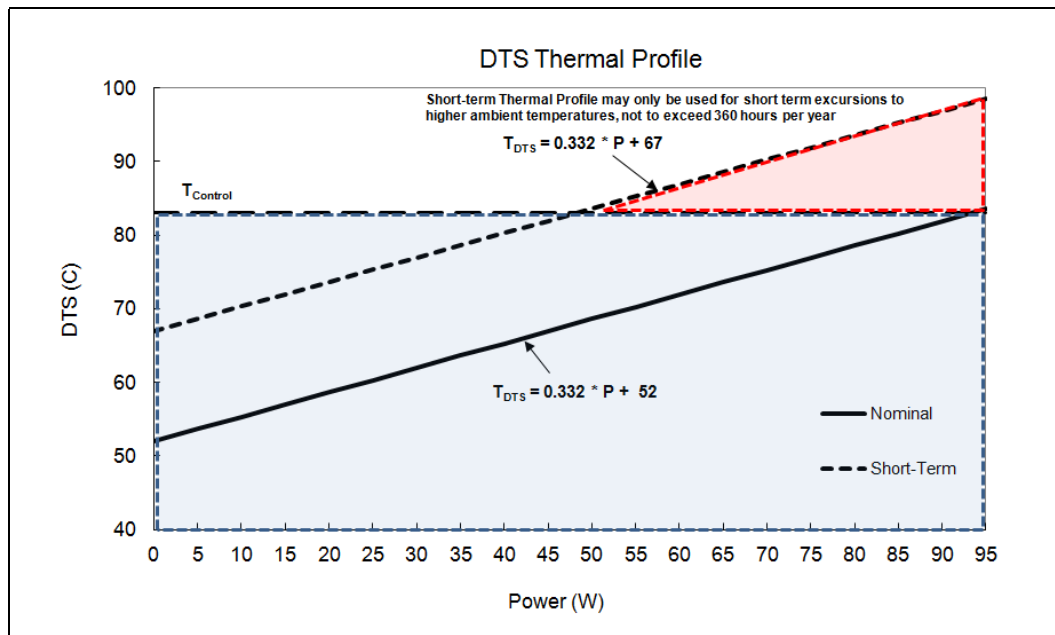
Figure 5-28. Tcase: 8-Core LV95W Thermal Profile, Embedded Server SKU



Notes:

1. This Thermal Profile is representative of a volumetrically constrained platform. Please refer to [Table 5-28](#) for discrete points that constitute the thermal profile.
2. Implementation of this Thermal Profile should result in virtually no TCC activation. Refer to the *Intel® Xeon® Processor E5-1600/E5-2600/E5-4600 Product Families Thermal/Mechanical Design Guide* for system and environmental implementation details.
3. The Nominal Thermal Profile must be used for all normal operating conditions or for products that do not require NEBS Level 3 compliance.
4. The Short-Term Thermal Profile may only be used for short-term excursions to higher ambient operating temperatures, not to exceed 96 hours per instance, 360 hours per year, and a maximum of 15 instances per year, as compliant with NEBS Level 3. Operation at the Short-Term Thermal Profile for durations exceeding 360 hours per year violate the processor thermal specifications and may result in permanent damage to the processor.

Figure 5-29. DTS: 8-Core LV95W Thermal Profile, Embedded Server SKU



Notes:

1. This Thermal Profile is representative of a volumetrically constrained platform. Please refer to Table 5-28 for discrete points that constitute the thermal profile.
2. Implementation of this Thermal Profile should result in virtually no TCC activation. Refer to the *Intel® Xeon® Processor E5-1600/E5-2600/E5-4600 Product Families Thermal/Mechanical Design Guide* for system and environmental implementation details.
3. The Nominal Thermal Profile must be used for all normal operating conditions or for products that do not require NEBS Level 3 compliance. As indicated by the blue shaded region, operation at DTS temperatures up to $T_{Control}$ is permitted at all power levels.
4. The Short-Term Thermal Profile may only be used for short-term excursions to higher ambient operating temperatures, not to exceed 96 hours per instance, 360 hours per year, and a maximum of 15 instances per year, as compliant with NEBS Level 3. Operation at the Short-Term Thermal Profile for durations exceeding 360 hours per year violate the processor thermal specifications and may result in permanent damage to the processor.

Table 5-28. 8-Core LV95W Thermal Profiles, Embedded Server SKU (Sheet 1 of 2)

Power (W)	Maximum T _{CASE} (°C)		Maximum DTS (°C)	
	Long Term	Short Term	Long Term	Short Term
0	52.6	67.6	52	67
5	53.7	68.7	54	69
10	54.8	69.8	55	70
15	55.8	70.8	57	72
20	56.9	71.9	59	74
25	58.0	73.0	60	75
30	59.1	74.1	62	77
35	60.1	75.1	64	79
40	61.2	76.2	65	80
45	62.3	77.3	67	82
50	63.4	78.4	69	84
55	64.4	79.4	70	85
60	65.5	80.5	72	87



Table 5-28. 8-Core LV95W Thermal Profiles, Embedded Server SKU (Sheet 2 of 2)

Power (W)	Maximum T _{CASE} (°C)		Maximum DTS (°C)	
	Long Term	Short Term	Long Term	Short Term
65	66.6	81.6	74	89
70	67.7	82.7	75	90
75	68.7	83.7	77	92
80	69.8	84.8	79	94
85	70.9	85.9	80	95
90	72.0	87.0	82	97
95	73.0	88.0	84	99

5.1.4.2 8-Core LV70W Thermal Specifications

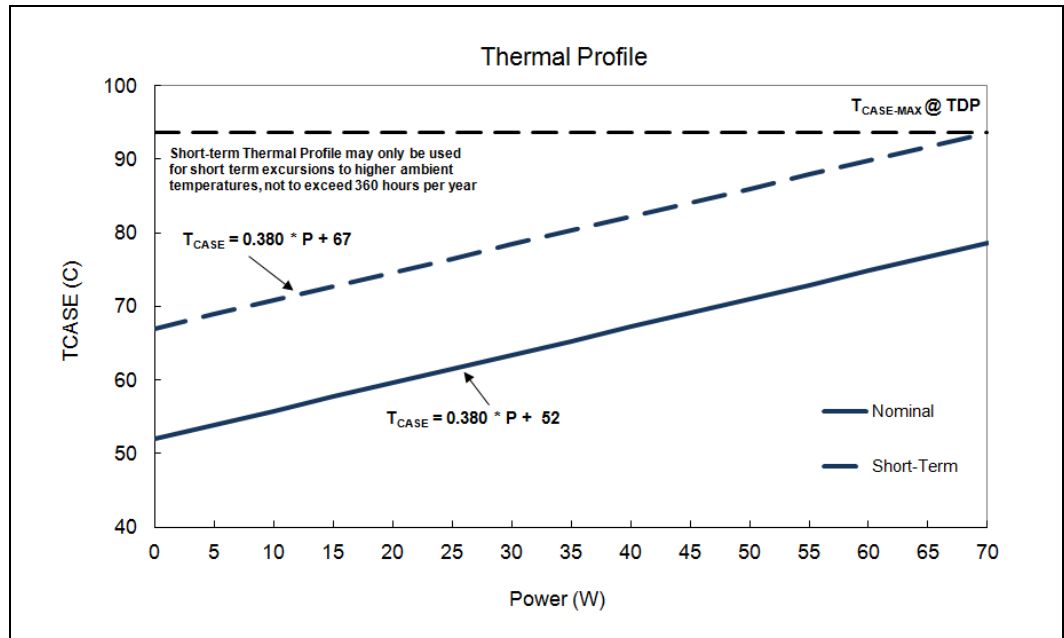
Table 5-29. Tcase: 8-Core LV70W Thermal Specifications, Embedded Server SKU

Core Frequency	Thermal Design Power (W)	Minimum T _{CASE} (°C)	Maximum T _{CASE} (°C)	Notes
Launch to FMB	70	5	See Figure 5-30 and Table 5-30	1, 2, 3, 4, 5

Notes:

1. These values are specified at V_{CC_MAX} for all processor frequencies. Systems must be designed to ensure the processor is not to be subjected to any static V_{CC} and I_{CC} combination wherein V_{CC} exceeds V_{CC_MAX} at specified ICC. Please refer to the electrical loadline specifications in Section 7.8.1.
2. Thermal Design Power (TDP) should be used for processor thermal solution design targets. TDP is not the maximum power that the processor can dissipate. TDP is measured at maximum T_{CASE}.
3. These specifications are based on initial final silicon simulations, which will be updated as further characterization data becomes available.
4. Power specifications are defined at all VIDs found in Table 7-3. The processor may be delivered under multiple VIDs for each frequency.
5. FMB, or Flexible Motherboard, guidelines provide a design target for meeting all planned processor frequency requirements.

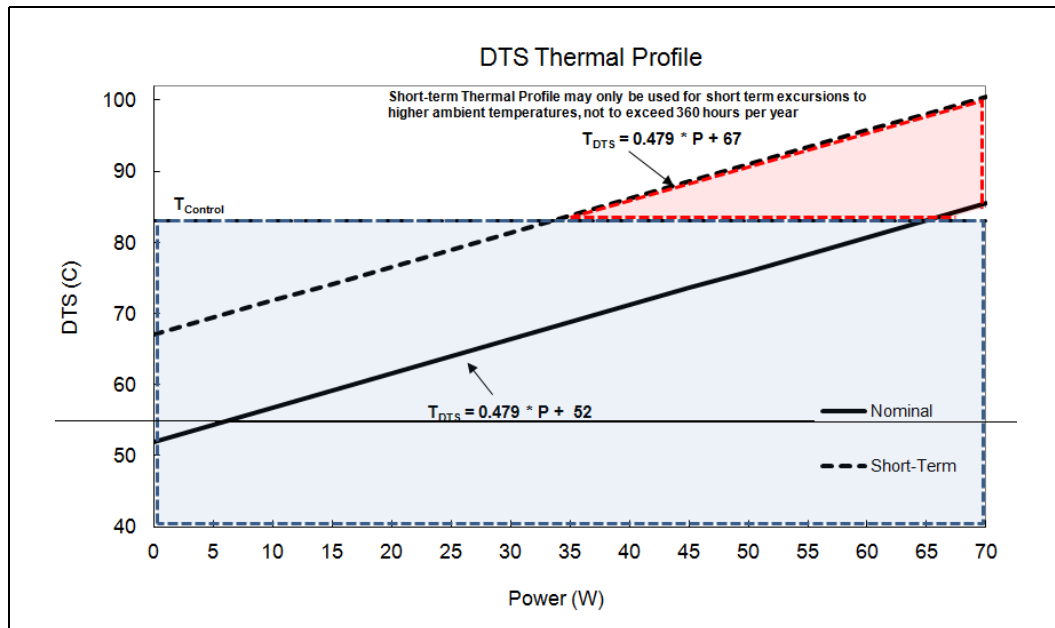
Figure 5-30. Tcase: 8-Core LV70W Thermal Profile, Embedded Server SKU



Notes:

1. This Thermal Profile is representative of a volumetrically constrained platform. Please refer to [Table 5-30](#) for discrete points that constitute the thermal profile.
2. Implementation of this Thermal Profile should result in virtually no TCC activation. Refer to the *Intel® Xeon® Processor E5-1600/E5-2600/E5-4600 Product Families Thermal/Mechanical Design Guide* for system and environmental implementation details.
3. The Nominal Thermal Profile must be used for all normal operating conditions or for products that do not require NEBS Level 3 compliance.
4. The Short-Term Thermal Profile may only be used for short-term excursions to higher ambient operating temperatures, not to exceed 96 hours per instance, 360 hours per year, and a maximum of 15 instances per year, as compliant with NEBS Level 3. Operation at the Short-Term Thermal Profile for durations exceeding 360 hours per year violate the processor thermal specifications and may result in permanent damage to the processor.

Figure 5-31. DTS: 8-Core LV70W Thermal Profile, Embedded Server SKU



Notes:

1. This Thermal Profile is representative of a volumetrically constrained platform. Please refer to [Table 5-28](#) for discrete points that constitute the thermal profile.
2. Implementation of this Thermal Profile should result in virtually no TCC activation. Refer to the *Intel® Xeon® Processor E5-1600/E5-2600/E5-4600 Product Families Thermal/Mechanical Design Guide* for system and environmental implementation details.
3. The Nominal Thermal Profile must be used for all normal operating conditions or for products that do not require NEBS Level 3 compliance. As indicated by the blue shaded region, operation at DTS temperatures up to $T_{Control}$ is permitted at all power levels.
4. The Short-Term Thermal Profile may only be used for short-term excursions to higher ambient operating temperatures, not to exceed 96 hours per instance, 360 hours per year, and a maximum of 15 instances per year, as compliant with NEBS Level 3. Operation at the Short-Term Thermal Profile for durations exceeding 360 hours per year violate the processor thermal specifications and may result in permanent damage to the processor.

Table 5-30. 8-Core LV70W Thermal Profile Table, Embedded Server SKU (Sheet 1 of 2)

Power (W)	Maximum T_{CASE} (°C)		Maximum DTS (°C)	
	Long Term	Short Term	Long Term	Short Term
0	52.0	67.0	52	67
5	53.8	68.8	54	69
10	55.6	70.6	57	72
15	57.4	72.4	59	74
20	59.2	74.2	62	77



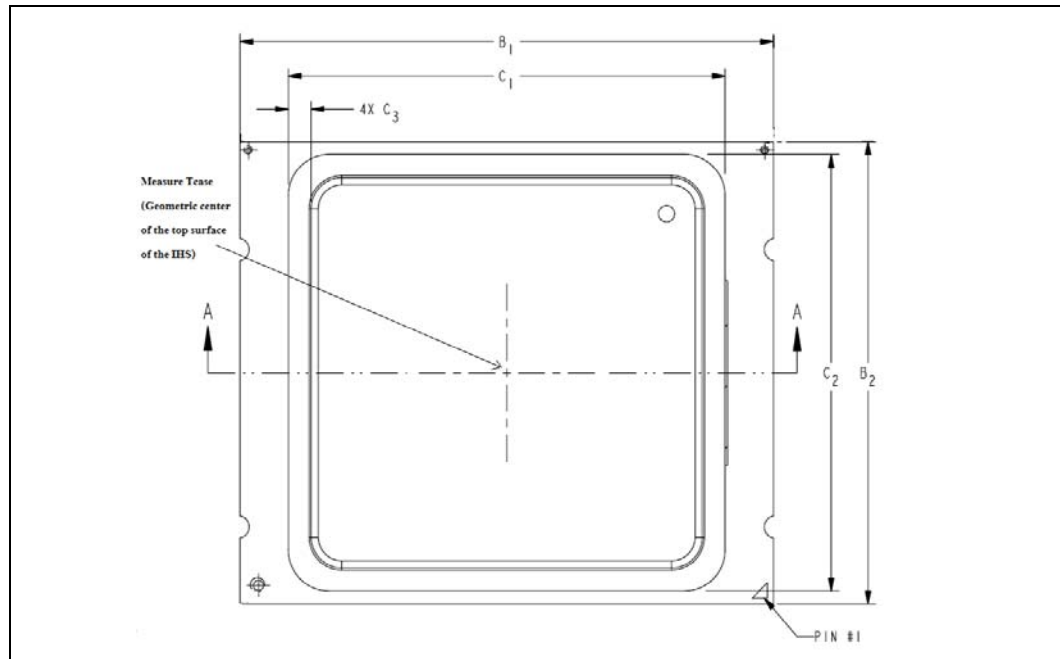
Table 5-30. 8-Core LV70W Thermal Profile Table, Embedded Server SKU (Sheet 2 of 2)

Power (W)	Maximum T _{CASE} (°C)		Maximum DTS (°C)	
	Long Term	Short Term	Long Term	Short Term
25	61.0	76.0	64	79
30	62.7	77.7	66	81
35	64.5	79.5	69	84
40	66.3	81.3	71	86
45	68.1	83.1	74	89
50	69.9	84.9	76	91
55	71.7	86.7	78	93
60	73.5	88.5	81	96
65	75.3	90.3	83	98
70	77.1	92.1	86	101

5.1.5 Thermal Metrology

The minimum and maximum case temperatures (T_{CASE}) specified in Table 5-2 through Table 5-30 are measured at the geometric top center of the processor integrated heat spreader (IHS). Figure 5-32 illustrates the location where T_{CASE} temperature measurements should be made. For detailed guidelines on temperature measurement methodology, refer to the Intel® Xeon® Processor E5-1600/E5-2600/E5-4600 Product Families Thermal/Mechanical Design Guide.

Figure 5-32. Case Temperature (T_{CASE}) Measurement Location



- Notes:**
1. Figure is not to scale and is for reference only.
 2. B1: Max = 52.57 mm, Min = 52.43 mm.
 3. B2: Max = 45.07 mm, Min = 44.93 mm.
 4. C1: Max = 43.1 mm, Min = 42.9 mm.
 5. C2: Max = 42.6 mm, Min = 42.4 mm.
 6. C3: Max = 2.35 mm, Min = 2.15 mm.



5.2 Processor Core Thermal Features

5.2.1 Processor Temperature

A new feature in the processor is a software readable field in the TEMPERATURE_TARGET MSR register that contains the minimum temperature at which the TCC will be activated and PROCHOT_N will be asserted. The TCC activation temperature is calibrated on a part-by-part basis and normal factory variation may result in the actual TCC activation temperature being higher than the value listed in the register. TCC activation temperatures may change based on processor stepping, frequency or manufacturing efficiencies.

5.2.2 Adaptive Thermal Monitor

The Adaptive Thermal Monitor feature provides an enhanced method for controlling the processor temperature when the processor silicon reaches its maximum operating temperature. Adaptive Thermal Monitor uses Thermal Control Circuit (TCC) activation to reduce processor power via a combination of methods. The first method (Frequency/SVID control) involves the processor adjusting its operating frequency (via the core ratio multiplier) and input voltage (via the SVID signals). This combination of reduced frequency and voltage results in a reduction to the processor power consumption. The second method (clock modulation) reduces power consumption by modulating (starting and stopping) the internal processor core clocks. The processor intelligently selects the appropriate TCC method to use on a dynamic basis. BIOS is not required to select a specific method.

The Adaptive Thermal Monitor feature must be enabled for the processor to be operating within specifications. Snooping and interrupt processing are performed in the normal manner while the TCC is active.

With a properly designed and characterized thermal solution, it is anticipated that the TCC would be activated for very short periods of time when running the most power intensive applications. The processor performance impact due to these brief periods of TCC activation is expected to be so minor that it would be immeasurable. An under-designed thermal solution that is not able to prevent excessive activation of the TCC in the anticipated ambient environment may cause a noticeable performance loss, and in some cases may result in a T_c that exceeds the specified maximum temperature which may affect the long-term reliability of the processor. In addition, a thermal solution that is significantly under-designed may not be capable of cooling the processor even when the TCC is active continuously. Refer to the *Intel® Xeon® Processor E5-1600/E5-2600/E5-4600 Product Families Thermal/Mechanical Design Guide* for information on designing a compliant thermal solution.

The duty cycle for the TCC, when activated by the Thermal Monitor, is factory configured and cannot be modified. The Thermal Monitor does not require any additional hardware, software drivers, or interrupt handling routines.

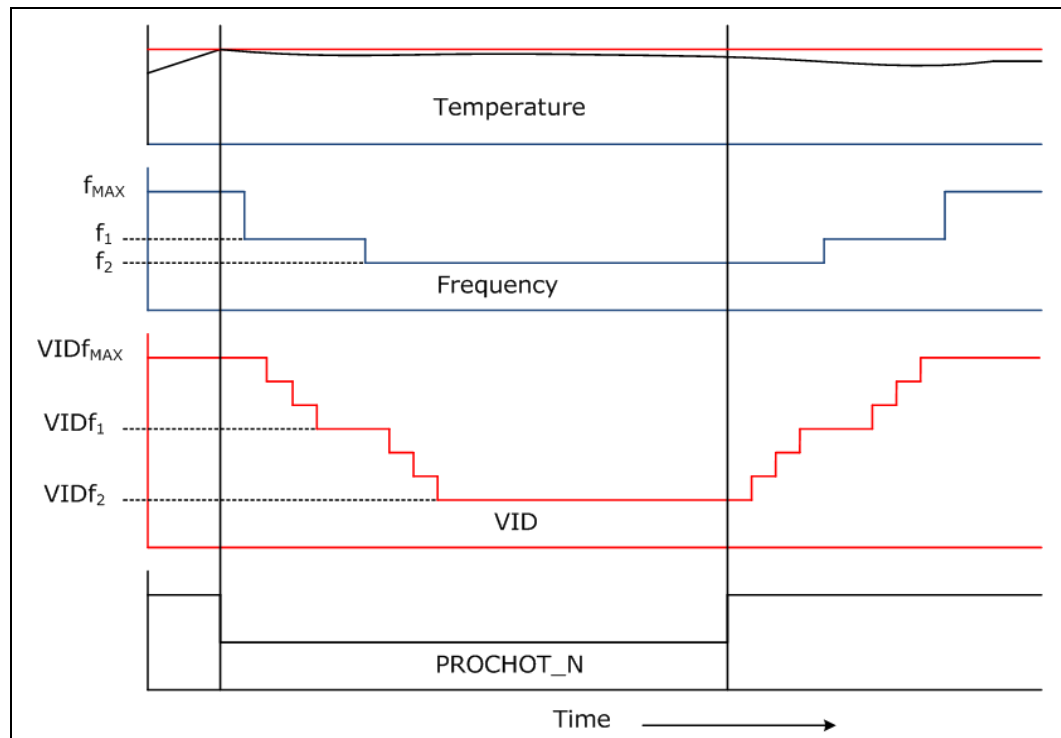
5.2.2.1 Frequency/SVID Control

The processor uses Frequency/SVID control whereby TCC activation causes the processor to adjust its operating frequency (via the core ratio multiplier) and VCC input voltage (via the SVID signals). This combination of reduced frequency and voltage results in a reduction to the processor power consumption.

This method includes multiple operating points, each consisting of a specific operating frequency and voltage. The first operating point represents the normal operating condition for the processor. The remaining points consist of both lower operating frequencies and voltages. When the TCC is activated, the processor automatically transitions to the new lower operating frequency. This transition occurs very rapidly (on the order of microseconds). Once the new operating frequency is engaged, the processor will transition to the new core operating voltage by issuing a new SVID code to the VCC voltage regulator. The voltage regulator must support dynamic SVID steps to support this method. During the voltage change, it will be necessary to transition through multiple SVID codes to reach the target operating voltage. Each step will be one SVID table entry (see [Table 7-3](#)). The processor continues to execute instructions during the voltage transition. Operation at the lower voltages reduces the power consumption of the processor.

A small amount of hysteresis has been included to prevent rapid active/inactive transitions of the TCC when the processor temperature is near its maximum operating temperature. Once the temperature has dropped below the maximum operating temperature, and the hysteresis timer has expired, the operating frequency and voltage transition back to the normal system operating point via the intermediate SVID/frequency points. Transition of the SVID code will occur first, to insure proper operation once the processor reaches its normal operating frequency. Refer to [Figure 5-33](#) for an illustration of this ordering.

Figure 5-33. Frequency and Voltage Ordering





5.2.2.2 Clock Modulation

Clock modulation is performed by alternately turning the clocks off and on at a duty cycle specific to the processor (factory configured to 37.5% on and 62.5% off for TM1). The period of the duty cycle is configured to 32 microseconds when the TCC is active. Cycle times are independent of processor frequency. A small amount of hysteresis has been included to prevent rapid active/inactive transitions of the TCC when the processor temperature is near its maximum operating temperature. Once the temperature has dropped below the maximum operating temperature, and the hysteresis timer has expired, the TCC goes inactive and clock modulation ceases. Clock modulation is automatically engaged as part of the TCC activation when the Frequency/SVID targets are at their minimum settings. It may also be initiated by software at a configurable duty cycle.

5.2.3 On-Demand Mode

The processor provides an auxiliary mechanism that allows system software to force the processor to reduce its power consumption. This mechanism is referred to as “On-Demand” mode and is distinct from the Adaptive Thermal Monitor feature. On-Demand mode is intended as a means to reduce system level power consumption. Systems must not rely on software usage of this mechanism to limit the processor temperature. If bit 4 of the IA32_CLOCK_MODULATION MSR is set to a ‘1’, the processor will immediately reduce its power consumption via modulation (starting and stopping) of the internal core clock, independent of the processor temperature. When using On-Demand mode, the duty cycle of the clock modulation is programmable via bits 3:0 of the same IA32_CLOCK_MODULATION MSR. In On-Demand mode, the duty cycle can be programmed from 6.25% on / 93.75% off to 93.75% on / 6.25% off in 6.25% increments. On-Demand mode may be used in conjunction with the Adaptive Thermal Monitor; however, if the system tries to enable On-Demand mode at the same time the TCC is engaged, the factory configured duty cycle of the TCC will override the duty cycle selected by the On-Demand mode.

5.2.4 PROCHOT_N Signal

An external signal, PROCHOT_N (processor hot), is asserted when the processor core temperature has reached its maximum operating temperature. If Adaptive Thermal Monitor is enabled (note it must be enabled for the processor to be operating within specification), the TCC will be active when PROCHOT_N is asserted. The processor can be configured to generate an interrupt upon the assertion or de-assertion of PROCHOT_N.

The PROCHOT_N signal is bi-directional in that it can either signal when the processor (any core) has reached its maximum operating temperature or be driven from an external source to activate the TCC. The ability to activate the TCC via PROCHOT_N can provide a means for thermal protection of system components.

As an output, PROCHOT_N will go active when the processor temperature monitoring sensor detects that one or more cores has reached its maximum safe operating temperature. This indicates that the processor Thermal Control Circuit (TCC) has been activated, if enabled. As an input, assertion of PROCHOT_N by the system will activate the TCC, if enabled, for all cores. TCC activation due to PROCHOT_N assertion by the system will result in the processor immediately transitioning to the minimum frequency and corresponding voltage (using Freq/SVID control). Clock modulation is not activated in this case. The TCC will remain active until the system de-asserts PROCHOT_N.



PROCHOT_N can allow voltage regulator (VR) thermal designs to target maximum sustained current instead of maximum current. Systems should still provide proper cooling for the VR, and rely on PROCHOT_N as a backup in case of system cooling failure. The system thermal design should allow the power delivery circuitry to operate within its temperature specification even while the processor is operating at its Thermal Design Power.

With a properly designed and characterized thermal solution, it is anticipated that PROCHOT_N will be asserted for very short periods of time when running the most power intensive applications. An under-designed thermal solution that is not able to prevent excessive assertion of PROCHOT_N in the anticipated ambient environment may cause a noticeable performance loss. Refer to the appropriate platform design guide and for details on implementing the bi-directional PROCHOT_N feature.

5.2.5 THERMTRIP_N Signal

Regardless of whether Adaptive Thermal Monitor is enabled, in the event of a catastrophic cooling failure, the processor will automatically shut down when the silicon has reached an elevated temperature (refer to the THERMTRIP_N definition in [Section 6, "Signal Descriptions"](#)). At this point, the THERMTRIP_N signal will go active and stay active. THERMTRIP_N activation is independent of processor activity and does not generate any Intel QuickPath Interconnect transactions. If THERMTRIP_N is asserted, all processor supplies (VCC, VTTA, VTTD, VSA, VCCPLL, VCCD) must be removed within the timeframe provided. The temperature at which THERMTRIP_N asserts is not user configurable and is not software visible.

5.2.6 Integrated Memory Controller (IMC) Thermal Features

5.2.6.1 DRAM Throttling Options

The Integrated Memory Controller (IMC) has two, independent mechanisms that cause system memory throttling:

- Open Loop Thermal Throttling (OLTT) and Hybrid OLTT (OLTT_Hybrid)
- Closed Loop Thermal Throttling (CLTT) and Hybrid CLTT (CLTT_Hybrid)

5.2.6.1.1 Open Loop Thermal Throttling (OLTT)

Pure energy based estimation for systems with no BMC or Intel ME. No memory temperature information is provided by the platform or DIMMs. The CPU is informed of the ambient temperature estimate by the BIOS or by a device via the PECCI interface. DIMM temperature estimates and bandwidth control are monitored and managed by the PCU on a per rank basis.

5.2.6.1.2 Hybrid Open Loop Thermal Throttling (OLTT_Hybrid)

Temperature information is provided by the platform (for example, BMC or Intel® Management Engine (Intel® ME)) through PECCI and the PCU interpolates gaps with energy based estimations.

5.2.6.1.3 Closed Loop Thermal Throttling (CLTT)

The processor periodically samples temperatures from the DIMM TSoD devices over a programmable interval. The PCU determines the hottest DIMM rank from TSoD data and informs the integrated memory controller for use in bandwidth throttling decisions.



5.2.6.2 Hybrid Closed Loop Thermal Throttling (CLTT_Hybrid)

The processor periodically samples temperature from the DIMM TSoD devices over a programmable interval and interpolates gaps or the BMC/Intel ME samples a motherboard thermal sensor in the memory subsection and provides this data to the PCU via the PECE interface. This data is combined with an energy based estimations calculated by the PCU. When needed, system memory is then throttled using CAS bandwidth control. The processor supports dynamic reprogramming of the memory thermal limits based on system thermal state by the BMC or Intel ME.

5.2.6.3 MEM_HOT_C01_N and MEM_HOT_C23_N Signal

The processor includes a pair of new bi-directional memory thermal status signals useful for manageability schemes. Each signal presents and receives thermal status for a pair of memory channels (channels 0 and 1 and channels 2 and 3).

- Input Function: The processor can periodically sense the MEM_HOT_{C01/C23}_N signals to detect if the platform is requesting a memory throttling event. Manageability hardware could drive this signal due to a memory voltage regulator thermal or electrical issue or because of a detected system thermal event (for example, fan is going to fail) other system devices are exceeding their thermal target. The input sense period of these signals are programmable, 100 us is the default value. The input sense assertion time recognized by the processor is programmable, 1 us is the default value. If the sense assertion time is programmed to zero, then the processor ignores all external assertions of MEM_HOT_{C01/C23}_N signals (in effect they become outputs).
- Output Function: The output behavior of the MEM_HOT_{C01/C23}_N signals supports Level mode. In this mode, MEM_HOT_{C01/C23}_N event temperatures are programmable via TEMP_OEM_HI, TEMP_LOW, TEMP_MID, and TEMP_HI threshold settings in the iMC. In Level mode, when asserted, the signal indicates to the platform that a BIOS-configured thermal threshold has been reached by one or more DIMMs in the covered channel pair.

5.2.6.4 Integrated Dual SMBus Master Controllers for SMI

The processor includes two integrated SMBus master controllers running at 100 KHz for dedicated PCU access to the serial presence detect (SPD) devices and thermal sensors (TSoD) on the DIMMs. Each controller is responsible for a pair of memory channels and supports up to eight SMBus slave devices. Note that clock-low stretching is not supported by the processor. To avoid design complexity and minimize package C-state transitions, the SMBus interface between the processor and DIMMs must be connected.

The SMBus controllers for the system memory interface support the following SMBus protocols/commands:

- Random byte Read
- Byte Write
- I²C* Write to Pointer Register
- I²C Present Pointer Register Word Read
- I²C Pointer Write Register Read.

Refer to the *System Management Bus (SMBus) Specification, Revision 2.0* for standing timing protocols and specific command structure details.

§



6 Signal Descriptions

This chapter describes the processor signals. They are arranged in functional groups according to their associated interface or category.

6.1 System Memory Interface Signals

Table 6-1. Memory Channel DDR0, DDR1, DDR2, DDR3

Signal Name	Description
DDR{0/1/2/3}_BA[2:0]	Bank Address. Defines the bank which is the destination for the current Activate, Read, Write, or Precharge command.
DDR{0/1/2/3}_CAS_N	Column Address Strobe.
DDR{0/1/2/3}_CKE[5:0]	Clock Enable.
DDR{0/1/2/3}_CLK_DN[3:0] DDR{0/1/2/3}_CLK_DP[3:0]	Differential clocks to the DIMM. All command and control signals are valid on the rising edge of clock.
DDR{0/1/2/3}_CS_N[9:0]	Chip Select. Each signal selects one rank as the target of the command and address.
DDR{0/1/2/3}_DQ[63:00]	Data Bus. DDR3 Data bits.
DDR{0/1/2/3}_DQS_DP[17:00] DDR{0/1/2/3}_DQS_DN[17:00]	Data strobes. Differential pair, Data/ECC Strobe. Differential strobes latch data/ECC for each DRAM. Different numbers of strobes are used depending on whether the connected DRAMs are x4, x8. Driven with edges in center of data, receive edges are aligned with data edges.
DDR{0/1/2/3}_ECC[7:0]	Check bits. An error correction code is driven along with data on these lines for DIMMs that support that capability
DDR{0/1/2/3}_MA[15:00]	Memory Address. Selects the Row address for Reads and writes, and the column address for activates. Also used to set values for DRAM configuration registers.
DDR{0/1/2/3}_MA_PAR	Odd parity across Address and Command.
DDR{0/1/2/3}_ODT[5:0]	On Die Termination. Enables DRAM on die termination during Data Write or Data Read transactions.
DDR{0/1/2/3}_PAR_ERR_N	Parity Error detected by Registered DIMM (one for each channel).
DDR{0/1/2/3}_RAS_N	Row Address Strobe.
DDR{0/1/2/3}_WE_N	Write Enable.

Table 6-2. Memory Channel Miscellaneous

Signal Name	Description
DDR_RESET_C01_N DDR_RESET_C23_N	System memory reset: Reset signal from processor to DRAM devices on the DIMMs. DDR_RESET_C01_N is used for memory channels 0 and 1 while DDR_RESET_C23_N is used for memory channels 2 and 3.
DDR_SCL_C01 DDR_SCL_C23	SMBus clock for the dedicated interface to the serial presence detect (SPD) and thermal sensors (TSoD) on the DIMMs. DDR_SCL_C01 is used for memory channels 0 and 1 while DDR_SCL_C23 is used for memory channels 2 and 3.
DDR_SDA_C01 DDR_SDA_C23	SMBus data for the dedicated interface to the serial presence detect (SPD) and thermal sensors (TSoD) on the DIMMs. DDR_SDA_C1 is used for memory channels 0 and 1 while DDR_SDA_C23 is used for memory channels 2 and 3.
DDR_VREFDQRX_C01 DDR_VREFDQRX_C23	Voltage reference for system memory reads. DDR_VREFDQRX_C01 is used for memory channels 0 and 1 while DDR_VREFDQRX_C23 is used for memory channels 2 and 3.
DDR_VREFDQTX_C01 DDR_VREFDQTX_C23	Voltage reference for system memory writes. DDR_VREFDQTX_C01 is used for memory channels 0 and 1 while DDR_VREFDQTX_C23 is used for memory channels 2 and 3. These signals are not connected.
DDR{01/23}_RCOMP[2:0]	System memory impedance compensation. Impedance compensation must be terminated on the system board using a precision resistor. See the appropriate Platform Design Guide (PDG) for implementation details.
DRAM_PWR_OK_C01 DRAM_PWR_OK_C23	Power good input signal used to indicate that the VCCD power supply is stable for memory channels 0 & 1 and channels 2 & 3.

6.2 PCI Express* Based Interface Signals

Note: PCI Express* Ports 1, 2 and 3 Signals are receive and transmit differential pairs.

Table 6-3. PCI Express* Port 1 Signals

Signal Name	Description
PE1A_RX_DN[3:0] PE1A_RX_DP[3:0]	PCIe* Receive Data Input
PE1B_RX_DN[7:4] PE1B_RX_DP[7:4]	PCIe* Receive Data Input
PE1A_TX_DN[3:0] PE1A_TX_DP[3:0]	PCIe* Transmit Data Output
PE1B_TX_DN[7:4] PE1B_TX_DP[7:4]	PCIe* Transmit Data Output

Table 6-4. PCI Express* Port 2 Signals (Sheet 1 of 2)

Signal Name	Description
PE2A_RX_DN[3:0] PE2A_RX_DP[3:0]	PCIe* Receive Data Input
PE2B_RX_DN[7:4] PE2B_RX_DP[7:4]	PCIe* Receive Data Input
PE2C_RX_DN[11:8] PE2C_RX_DP[11:8]	PCIe* Receive Data Input



Table 6-4. PCI Express* Port 2 Signals (Sheet 2 of 2)

Signal Name	Description
PE2D_RX_DN[15:12] PE2D_RX_DP[15:12]	PCIe* Receive Data Input
PE2A_TX_DN[3:0] PE2A_TX_DP[3:0]	PCIe* Transmit Data Output
PE2B_TX_DN[7:4] PE2B_TX_DP[7:4]	PCIe* Transmit Data Output
PE2C_TX_DN[11:8] PE2C_TX_DP[11:8]	PCIe* Transmit Data Output
PE2D_TX_DN[15:12] PE2D_TX_DP[15:12]	PCIe* Transmit Data Output

Table 6-5. PCI Express* Port 3 Signals

Signal Name	Description
PE3A_RX_DN[3:0] PE3A_RX_DP[3:0]	PCIe* Receive Data Input
PE3B_RX_DN[7:4] PE3B_RX_DP[7:4]	PCIe* Receive Data Input
PE3C_RX_DN[11:8] PE3C_RX_DP[11:8]	PCIe* Receive Data Input
PE3D_RX_DN[15:12] PE3D_RX_DP[15:12]	PCIe* Receive Data Input
PE3A_TX_DN[3:0] PE3A_TX_DP[3:0]	PCIe* Transmit Data Output
PE3B_TX_DN[7:4] PE3B_TX_DP[7:4]	PCIe* Transmit Data Output
PE3C_TX_DN[11:8] PE3C_TX_DP[11:8]	PCIe* Transmit Data Output
PE3D_TX_DN[15:12] PE3D_TX_DP[15:12]	PCIe* Transmit Data Output

Table 6-6. PCI Express* Miscellaneous Signals (Sheet 1 of 2)

Signal Name	Description
PE_RBIAS	This input is used to control PCI Express* bias currents. A 50 ohm 1% tolerance resistor must be connected from this land to VSS by the platform. PE_RBIAS is required to be connected as if the link is being used even when PCIe* is not used. Refer to the appropriate Platform Design Guide (PDG) for further details.
PE_RBIAS_SENSE	Provides dedicated bias resistor sensing to minimize the voltage drop caused by packaging and platform effects. PE_RBIAS_SENSE is required to be connected as if the link is being used even when PCIe* is not used. Refer to the appropriate Platform Design Guide (PDG) for further details.
PE_VREF_CAP	PCI Express* voltage reference used to measure the actual output voltage and comparing it to the assumed voltage. A 0.01uF capacitor must be connected from this land to VSS.
PEHPSCL	PCI Express* Hot-Plug SMBus Clock: Provides PCI Express* hot-plug support via a dedicated SMBus interface. Requires an external general purpose input/output (GPIO) expansion device on the platform.



Table 6-6. PCI Express* Miscellaneous Signals (Sheet 2 of 2)

Signal Name	Description
PEHPSDA	PCI Express* Hot-Plug SMBus Data: Provides PCI Express* hot-plug support via a dedicated SMBus interface. Requires an external general purpose input/output (GPIO) expansion device on the platform.

Note: Refer to the appropriate Platform Design Guide (PDG) for additional implementation details.

6.3 DMI2/PCI Express* Port 0 Signals

Table 6-7. DMI2 and PCI Express* Port 0 Signals

Signal Name	Description
DMI_RX_DN[3:0] DMI_RX_DP[3:0]	DMI2 Receive Data Input
DMI_TX_DP[3:0] DMI_TX_DN[3:0]	DMI2 Transmit Data Output

6.4 Intel QuickPath Interconnect Signals

Table 6-8. Intel QPI Port 0 and 1 Signals

Signal Name	Description
QPI{0/1}_CLKRX_DN/DP	Reference Clock Differential Input. These pins provide the PLL reference clock differential input. The Intel QPI forward clock frequency is half the Intel QPI data rate.
QPI{0/1}_CLKTX_DN/DP	Reference Clock Differential Output. These pins provide the PLL reference clock differential input. The Intel QPI forward clock frequency is half the Intel QPI data rate.
QPI{0/1}_DRX_DN/DP[19:00]	Intel QPI Receive data input.
QPI{0/1}_DTX_DN/DP[19:00]	Intel QPI Transmit data output.

Table 6-9. Intel QPI Miscellaneous Signals

Signal Name	Description
QPI_RBIAS	This input is used to control Intel QPI bias currents. QPI_RBIAS is required to be connected as if the link is being used even when Intel QPI is not used. Refer to the appropriate Platform Design Guide (PDG) for further details.
QPI_RBIAS_SENSE	Provides dedicated bias resistor sensing to minimize the voltage drop caused by packaging and platform effects. QPI_RBIAS_SENSE is required to be connected as if the link is being used even when Intel QPI is not used. Refer to the appropriate Platform Design Guide (PDG) for further details.
QPI_VREF_CAP	Intel QPI voltage reference used to measure the actual output voltage and comparing it to the assumed voltage. Refer to the appropriate Platform Design Guide (PDG) for further details.

Note: Refer to the appropriate Platform Design Guide (PDG) for additional implementation details.



6.5 PECE Signal

Table 6-10. PECE Signals

Signal Name	Description
PECE	PECE (Platform Environment Control Interface) is the serial sideband interface to the processor and is used primarily for thermal, power and error management. Details regarding the PECE electrical specifications, protocols and functions can be found in the Platform Environment Control Interface Specification.

6.6 System Reference Clock Signals

Table 6-11. System Reference Clock (BCLK{0/1}) Signals

Signal Name	Description
BCLK{0/1}_D[N/P]	Reference Clock Differential input. These pins provide the PLL reference clock differential input into the processor. Both 100MHz BCLK0 and BCLK1 from the same clock source provide the required reference clock inputs to the various PLLs inside the CPU.

6.7 JTAG and TAP Signals

Table 6-12. JTAG and TAP Signals

Signal Name	Description
BPM_N[7:0]	Breakpoint and Performance Monitor Signals: I/O signals from the processor that indicate the status of breakpoints and programmable counters used for monitoring processor performance. These are 100 MHz signals.
EAR_N	External Alignment of Reset, used to bring the processor up into a deterministic state. This signal is pulled up on the die, refer to Table 7-6 for details.
PRDY_N	Probe Mode Ready is a processor output used by debug tools to determine processor debug readiness.
PREQ_N	Probe Mode Request is used by debug tools to request debug operation of the processor.
TCK	TCK (Test Clock) provides the clock input for the processor Test Bus (also known as the Test Access Port).
TDI	TDI (Test Data In) transfers serial test data into the processor. TDI provides the serial input needed for JTAG specification support.
TDO	TDO (Test Data Out) transfers serial test data out of the processor. TDO provides the serial output needed for JTAG specification support.
TMS	TMS (Test Mode Select) is a JTAG specification support signal used by debug tools.
TRST_N	TRST_N (Test Reset) resets the Test Access Port (TAP) logic. TRST_N must be driven low during power on Reset.

Note: Refer to the appropriate Platform Design Guide (PDG) for Debug Port implementation details.



6.8 Serial VID Interface (SVID) Signals

Table 6-13. SVID Signals

SVIDALERT_N	Serial VID alert.
SVIDCLK	Serial VID clock.
SVIDDATA	Serial VID data out.

6.9 Processor Asynchronous Sideband and Miscellaneous Signals

Table 6-14. Processor Asynchronous Sideband Signals (Sheet 1 of 3)

Signal Name	Description
BIST_ENABLE	BIST Enable Strap. Input which allows the platform to enable or disable built-in self test (BIST) on the processor. This signal is pulled up on the die, refer to Table 7-6 for details.
BMCINIT	BMC Initialization Strap. Indicates whether Service Processor Boot Mode should be used. Used in combination with FRMAGENT and SOCKET_ID inputs. <ul style="list-style-type: none"> 0: Service Processor Boot Mode Disabled. Example boot modes: Local PCH (this processor hosts a legacy PCH with firmware behind it), Intel QPI Link Boot (for processors one hop away from the FW agent), or Intel QPI Link Init (for processors more than one hop away from the firmware agent). 1: Service Processor Boot Mode Enabled. In this mode of operation, the processor performs the absolute minimum internal configuration and then waits for the Service Processor to complete its initialization. The socket boots after receiving a "GO" handshake signal via a firmware scratchpad register. This signal is pulled down on the die, refer to Table 7-6 for details.
CAT_ERR_N	Indicates that the system has experienced a fatal or catastrophic error and cannot continue to operate. The processor will assert CAT_ERR_N for nonrecoverable machine check errors and other internal unrecoverable errors. It is expected that every processor in the system will wire-OR CAT_ERR_N for all processors. Since this is an I/O land, external agents are allowed to assert this land which will cause the processor to take a machine check exception. This signal is sampled after PWRGOOD assertion. On the processor, CAT_ERR_N is used for signaling the following types of errors: <ul style="list-style-type: none"> Legacy MCERR's, CAT_ERR_N is asserted for 16 BCLs. Legacy IERR's, CAT_ERR_N remains asserted until warm or cold reset.
CPU_ONLY_RESET	Resets all the processors on the platform without resetting the DMI2 links.
ERROR_N[2:0]	Error status signals for integrated I/O (IIO) unit: <ul style="list-style-type: none"> 0 = Hardware correctable error (no operating system or firmware action necessary) 1 = Non-fatal error (operating system or firmware action required to contain and recover) 2 = Fatal error (system reset likely required to recover)
FRMAGENT	Bootable Firmware Agent Strap. This input configuration strap used in combination with SOCKET_ID to determine whether the socket is a legacy socket, bootable firmware agent is present, and DMI links are used in PCIe* mode (instead of DMI2 mode). The firmware flash ROM is located behind the local PCH attached to the processor via the DMI2 interface. This signal is pulled down on the die, refer to Table 7-6 for details.
MEM_HOT_C01_N MEM_HOT_C23_N	Memory throttle control. MEM_HOT_C01_N and MEM_HOT_C23_N signals have two modes of operation – input and output mode. Input mode is externally asserted and is used to detect external events such as VR_HOT# from the memory voltage regulator and causes the processor to throttle the appropriate memory channels. Output mode is asserted by the processor known as level mode. In level mode, the output indicates that a particular branch of memory subsystem is hot. MEM_HOT_C01_N is used for memory channels 0 & 1 while MEM_HOT_C23_N is used for memory channels 2 & 3.
PMSYNC	Power Management Sync. A sideband signal to communicate power management status from the Platform Controller Hub (PCH) to the processor.



Table 6-14. Processor Asynchronous Sideband Signals (Sheet 2 of 3)

Signal Name	Description
PROCHOT_N	PROCHOT_N will go active when the processor temperature monitoring sensor detects that the processor has reached its maximum safe operating temperature. This indicates that the processor Thermal Control Circuit has been activated, if enabled. This signal can also be driven to the processor to activate the Thermal Control Circuit. This signal is sampled after PWRGOOD assertion. If PROCHOT_N is asserted at the deassertion of RESET_N, the processor will tristate its outputs.
PWRGOOD	Power Good is a processor input. The processor requires this signal to be a clean indication that BCLK, VTTA/VTTD, VSA, VCCPLL, and VCCD_01 and VCCD_23 supplies are stable and within their specifications. “Clean” implies that the signal will remain low (capable of sinking leakage current), without glitches, from the time that the power supplies are turned on until they come within specification. The signal must then transition monotonically to a high state. PWRGOOD can be driven inactive at any time, but clocks and power must again be stable before a subsequent rising edge of PWRGOOD. PWRGOOD transitions from inactive to active when all supplies except VCC are stable. VCC has a VBOOT of zero volts and is not included in PWRGOOD indication in this phase. However, for the active to inactive transition, if any CPU power supply (VCC, VTTA/VTTD, VSA, VCCD, or VCCPLL) is about to fail or is out of regulation, the PWRGOOD is to be negated. The signal must be supplied to the processor; it is used to protect internal circuits against voltage sequencing issues. It should be driven high throughout boundary scan operation. Note: VCC has a Vboot setting of 0.0V and is not included in the PWRGOOD indication and VSA has a Vboot setting of 0.9V. Refer to the <i>VR12/IMVP7 Pulse Width Modulation Specification</i> .
RESET_N	Asserting the RESET_N signal resets the processor to a known state and invalidates its internal caches without writing back any of their contents. Note some PLL, Intel QuickPath Interconnect and error states are not effected by reset and only PWRGOOD forces them to a known state.
RSVD	RESERVED. All signals that are RSVD must be left unconnected on the board. Refer to Section 7.1.10, “Reserved or Unused Signals” for details.
SAFE_MODE_BOOT	Safe mode boot Strap. SAFE_MODE_BOOT allows the processor to wake up safely by disabling all clock gating, this allows BIOS to load registers or patches if required. This signal is sampled after PWRGOOD assertion. The signal is pulled down on the die, refer to Table 7-6 for details.
SOCKET_ID[1:0]	Socket ID Strap. Socket identification configuration straps for establishing the PECL address, Intel QPI Node ID, and other settings. This signal is used in combination with FRMAGENT to determine whether the socket is a legacy socket, bootable firmware agent is present, and DMI links are used in PCIe* mode (instead of DMI2 mode). Each processor socket consumes one Node ID, and there are 128 Home Agent tracker entries. This signal is pulled down on the die, refer to Table 7-6 for details.
TEST[4:0]	Test[4:0] must be individually connected to an appropriate power source or ground through a resistor for proper processor operation. Refer to the appropriate Platform Design Guide (PDG) for additional implementation details.
THERMTRIP_N	Assertion of THERMTRIP_N (Thermal Trip) indicates one of two possible over-temperature conditions: One, the processor junction temperature has reached a level beyond which permanent silicon damage may occur and Two, the system memory interface has exceeded a critical temperature limit set by BIOS. Measurement of the processor junction temperature is accomplished through multiple internal thermal sensors that are monitored by the Digital Thermal Sensor (DTS). Simultaneously, the Power Control Unit (PCU) monitors external memory temperatures via the dedicated SMBus interface to the DIMMs. If any of the DIMMs exceed the BIOS defined limits, the PCU will signal THERMTRIP_N to prevent damage to the DIMMs. Once activated, the processor will stop all execution and shut down all PLLs. To further protect the processor, its core voltage (VCC), VTTA, VTTD, VSA, VCCPLL, VCCD supplies must be removed following the assertion of THERMTRIP_N. Once activated, THERMTRIP_N remains latched until RESET_N is asserted. While the assertion of the RESET_N signal may de-assert THERMTRIP_N, if the processor’s junction temperature remains at or above the trip level, THERMTRIP_N will again be asserted after RESET_N is de-asserted. This signal can also be asserted if the system memory interface has exceeded a critical temperature limit set by BIOS. This signal is sampled after PWRGOOD assertion.



Table 6-14. Processor Asynchronous Sideband Signals (Sheet 3 of 3)

Signal Name	Description
TXT_AGENT	Intel TXT Platform Enable Strap. 0 = Default. The socket is not the Intel TXT Agent. 1 = The socket is the Intel TXT Agent. In non-Scalable DP platforms, the legacy socket (identified by SOCKET_ID[1:0] = 00b) with Intel TXT Agent should always set the TXT_AGENT to 1b. On Scalable DP platforms the Intel TXT AGENT is at the Node Controller. Refer to the Platform Design Guide for more details. This signal is pulled down on the die, refer to Table 7-6 for details.
TXT_PLTEN	Intel TXT Platform Enable Strap. 0 = The platform is not Intel TXT enabled. All sockets should be set to zero. Scalable DP (sDP) platforms should choose this setting if the Node Controller does not support Intel TXT. 1 = Default. The platform is Intel TXT enabled. All sockets should be set to one. In a non-Scalable DP platform this is the default. When this is set, Intel TXT functionality requires user to explicitly enable Intel TXT via BIOS setup. This signal is pulled up on the die, refer to Table 7-6 for details.

Table 6-15. Miscellaneous Signals

Signal Name	Description
IVT_ID_N	This output can be used by the platform to determine if the installed processor is a future processor planned for the Intel® Xeon® processor E5-1600/E5-2600/E5-4600 product families-based Platform. There is no connection to the processor silicon for this signal. This signal is also used by the VCCPLL and VTT rails to switch their output voltage to support future processors.
SKTOCC_N	SKTOCC_N (Socket occupied) is used to indicate that a processor is present. This is pulled to ground on the processor package; there is no connection to the processor silicon for this signal.

6.10 Processor Power and Ground Supplies

Table 6-16. Power and Ground Signals (Sheet 1 of 2)

Signal Name	Description
VCC	Variable power supply for the processor cores, lowest level caches (LLC), ring interface, and home agent. It is provided by a VRM/EVRD 12.0 compliant regulator for each CPU socket. The output voltage of this supply is selected by the processor, using the serial voltage ID (SVID) bus. Note: VCC has a Vboot setting of 0.0V and is not included in the PWRGOOD indication. Refer to the <i>VR12/IMVP7 Pulse Width Modulation Specification</i> .
VCC_SENSE VSS_VCC_SENSE	VCC_SENSE and VSS_VCC_SENSE provide an isolated, low impedance connection to the processor core power and ground. These signals must be connected to the voltage regulator feedback circuit, which insures the output voltage (that is, processor voltage) remains within specification. Please see the applicable platform design guide for implementation details.
VSA_SENSE VSS_VSA_SENSE	VSA_SENSE and VSS_VSA_SENSE provide an isolated, low impedance connection to the processor system agent (VSA) power plane. These signals must be connected to the voltage regulator feedback circuit, which insures the output voltage (that is, processor voltage) remains within specification. Please see the applicable platform design guide for implementation details.



Table 6-16. Power and Ground Signals (Sheet 2 of 2)

Signal Name	Description
VTTD_SENSE VSS_VTTD_SENSE	VTTD_SENSE and VSS_VTTD_SENSE provide an isolated, low impedance connection to the processor I/O power plane. These signals must be connected to the voltage regulator feedback circuit, which insures the output voltage (that is, processor voltage) remains within specification. Please see the applicable platform design guide for implementation details.
VCCD_01 and VCCD_23	Variable power supply for the processor system memory interface. Provided by two VRM/EVRD 12.0 compliant regulators per CPU socket. VCCD_01 and VCCD_23 are used for memory channels 0, 1, 2, and 3 respectively. The valid voltage of this supply (1.50 V or 1.35 V) is configured by BIOS after determining the operating voltages of the installed memory. VCCD_01 and VCCD_23 will also be referred to as VCCD. Note: The processor must be provided VCCD_01 and VCCD_23 for proper operation, even in configurations where no memory is populated. A VRM/EVRD 12.0 controller is recommended, but not required.
VCCPLL	Fixed power supply (1.8V) for the processor phased lock loop (PLL).
VSA	Variable power supply for the processor system agent units. These include logic (non-I/O) for the integrated I/O controller, the integrated memory controller (IMC), the Intel QPI agent, and the Power Control Unit (PCU). The output voltage of this supply is selected by the processor, using the serial voltage ID (SVID) bus. Note: VSA has a Vboot setting of 0.9V. Refer to the <i>VR12/IMVP7 Pulse Width Modulation Specification</i> .
VSS	Processor ground node.
VTTA VTTD	Combined fixed analog and digital power supply for I/O sections of the processor Intel QPI interface, Direct Media Interface Gen 2 (DMI2) interface, and PCI Express* interface. These signals will also be referred to as VTT. Please see the appropriate Platform Design Guide (PDG) for implementation details.

§





7 Electrical Specifications

7.1 Processor Signaling

The processor includes 2011 lands, which utilize various signaling technologies. Signals are grouped by electrical characteristics and buffer type into various signal groups. These include DDR3 (Reference Clock, Command, Control, and Data), PCI Express*, DMI2, Intel QuickPath Interconnect, Platform Environmental Control Interface (PECI), System Reference Clock, SMBus, JTAG and Test Access Port (TAP), SVID Interface, Processor Asynchronous Sideband, Miscellaneous, and Power/Other signals. Refer to [Table 7-5](#) for details.

Detailed layout, routing, and termination guidelines corresponding to these signal groups can be found in the applicable platform design guide (Refer to [Section 1.7](#), “Related Documents”).

Intel strongly recommends performing analog simulations of all interfaces. Please refer to [Section 1.7](#), “Related Documents” for signal integrity model availability.

7.1.1 System Memory Interface Signal Groups

The system memory interface utilizes DDR3 technology, which consists of numerous signal groups. These include: Reference Clocks, Command Signals, Control Signals, and Data Signals. Each group consists of numerous signals, which may utilize various signaling technologies. Please refer to [Table 7-5](#) for further details. Throughout this chapter the system memory interface maybe referred to as DDR3.

7.1.2 PCI Express* Signals

The PCI Express* Signal Group consists of PCI Express* ports 1, 2, and 3, and PCI Express* miscellaneous signals. Please refer to [Table 7-5](#) for further details.

7.1.3 DMI2/PCI Express* Signals

The Direct Media Interface Gen 2 (DMI2) sends and receives packets and/or commands to the PCH. The DMI2 is an extension of the standard PCI Express* Specification. The DMI2/PCI Express* Signals consist of DMI2 receive and transmit input/output signals and a control signal to select DMI2 or PCIe* 2.0 operation for port 0. Please refer to [Table 7-5](#) for further details.

7.1.4 Intel QuickPath Interconnect (Intel QPI)

The processor provides two Intel QPI port for high speed serial transfer between other processors. Each port consists of two uni-directional links (for transmit and receive). A differential signaling scheme is utilized, which consists of opposite-polarity (DP, DN) signal pairs.

7.1.5 Platform Environmental Control Interface (PECI)

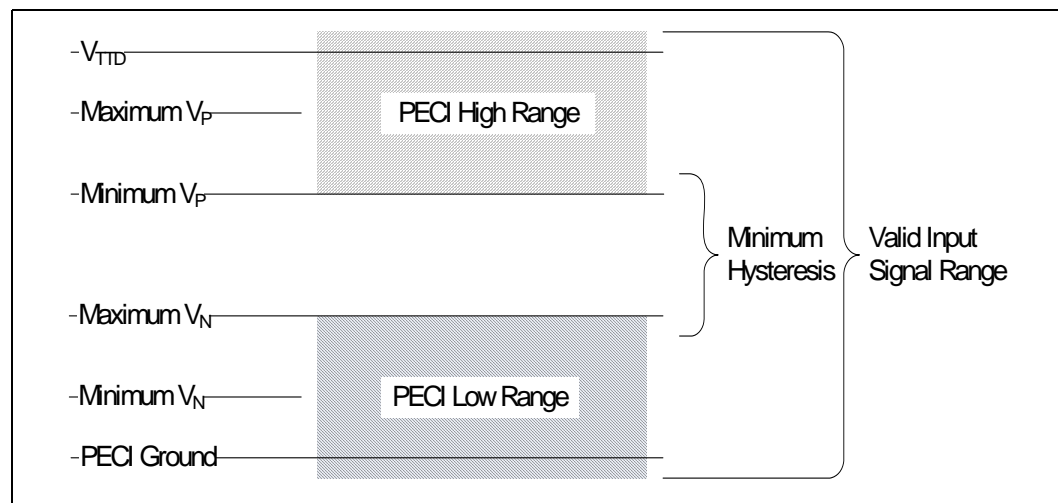
PECI is an Intel proprietary interface that provides a communication channel between Intel processors and chipset components to external system management logic and thermal monitoring devices. The processor contains a Digital Thermal Sensor (DTS) that reports a relative die temperature as an offset from Thermal Control Circuit (TCC) activation temperature. Temperature sensors located throughout the die are implemented as analog-to-digital converters calibrated at the factory. PECI provides an interface for external devices to read processor temperature, perform processor manageability functions, and manage processor interface tuning and diagnostics. Please refer to [Section 2.5, “Platform Environment Control Interface \(PECI\)”](#) for processor specific implementation details for PECI.

The PECI interface operates at a nominal voltage set by V_{TDD} . The set of DC electrical specifications shown in [Table 7-17](#) is used with devices normally operating from a V_{TDD} interface supply.

7.1.5.1 Input Device Hysteresis

The PECI client and host input buffers must use a Schmitt-triggered input design for improved noise immunity. Please refer to [Figure 7-1](#) and [Table 7-17](#).

Figure 7-1. Input Device Hysteresis



7.1.6 System Reference Clocks (BCLK{0/1}_DP, BCLK{0/1}_DN)

The processor core, processor uncore, Intel® QuickPath Interconnect link, PCI Express* and DDR3 memory interface frequencies) are generated from BCLK{0/1}_DP and BCLK{0/1}_DN signals. There is no direct link between core frequency and Intel QuickPath Interconnect link frequency (for example, no core frequency to Intel QuickPath Interconnect multiplier). The processor maximum core frequency, Intel QuickPath Interconnect link frequency and DDR memory frequency are set during manufacturing. It is possible to override the processor core frequency setting using software. This permits operation at lower core frequencies than the factory set maximum core frequency.



The processor core frequency is configured during reset by using values stored within the device during manufacturing. The stored value sets the lowest core multiplier at which the particular processor can operate. If higher speeds are desired, the appropriate ratio can be configured via the IA32_PERF_CTL MSR (MSR 199h); Bits [15:0].

Clock multiplying within the processor is provided by the internal phase locked loop (PLL), which requires a constant frequency BCLK{0/1}_DP, BCLK{0/1}_DN input, with exceptions for spread spectrum clocking. DC specifications for the BCLK{0/1}_DP, BCLK{0/1}_DN inputs are provided in [Table 7-18](#). These specifications must be met while also meeting the associated signal quality specifications outlined in [Section 7.9](#).

7.1.6.1 PLL Power Supply

An on-die PLL filter solution is implemented on the processor. Refer to [Table 7-11](#) for DC specifications and to the applicable platform design guide for decoupling and routing guidelines.

7.1.7 JTAG and Test Access Port (TAP) Signals

Due to the voltage levels supported by other components in the JTAG and Test Access Port (TAP) logic, Intel recommends the processor be first in the TAP chain, followed by any other components within the system. Please refer to the *Intel® Xeon® Processor E5-1600/E5-2600/E5-4600 Product Families – BSDL (Boundary Scan Description Language)* for more details. A translation buffer should be used to connect to the rest of the chain unless one of the other components is capable of accepting an input of the appropriate voltage. Two copies of each signal may be required with each driving a different voltage level.

7.1.8 Processor Sideband Signals

The processor include asynchronous sideband signals that provide asynchronous input, output or I/O signals between the processor and the platform or Platform Controller Hub. Details can be found in [Table 7-5](#) and the applicable platform design guide.

All Processor Asynchronous Sideband input signals are required to be asserted/deasserted for a defined number of BCLKs in order for the processor to recognize the proper signal state. Refer to [Section 7.9](#) for applicable signal integrity specifications.

7.1.9 Power, Ground and Sense Signals

Processors also include various other signals including power/ground and sense points. Details can be found in [Table 7-5](#) and the applicable platform design guide.

7.1.9.1 Power and Ground Lands

All V_{CC} , V_{CCPLL} , V_{SA} , V_{CCD} , V_{TTA} , and V_{TTD} lands must be connected to their respective processor power planes, while all V_{SS} lands must be connected to the system ground plane. Refer to the applicable platform design guide for decoupling, voltage plane and routing guidelines for each power supply voltage.

For clean on-chip power distribution, processors include lands for all required voltage supplies. These are listed in [Table 7-1](#).



Table 7-1. Power and Ground Lands

Power and Ground Lands	Number of Lands	Comments
V _{CC}	208	Each V _{CC} land must be supplied with the voltage determined by the SVID Bus signals. Table 7-3 Defines the voltage level associated with each core SVID pattern. Table 7-11 , Figure 7-2 , and Figure 7-5 represent V _{CC} static and transient limits. V _{CC} has a VBOOT setting of 0.0V.
V _{CCPLL}	3	Each V _{CCPLL} land is connected to a 1.80 V supply, power the Phase Lock Loop (PLL) clock generation circuitry. An on-die PLL filter solution is implemented within the processor.
V _{CCD_01} V _{CCD_23}	51	Each V _{CCD} land is connected to a switchable 1.50 V and 1.35 V supply, provide power to the processor DDR3 interface. These supplies also power the DDR3 memory subsystem. V _{CCD} is also controlled by the SVID Bus. V _{CCD} is the generic term for V _{CCD_01} , V _{CCD_23} .
V _{TTA}	14	V _{TTA} lands must be supplied by a fixed 1.05 V supply.
V _{TTD}	19	V _{TTD} lands must be supplied by a fixed 1.05 V supply.
V _{SA}	25	Each V _{SA} land must be supplied with the voltage determined by the SVID Bus signals, typically set at 0.965V. V _{SA} has a VBOOT setting of 0.9 V.
V _{SS}	548	Ground

7.1.9.2 Decoupling Guidelines

Due to its large number of transistors and high internal clock speeds, the processor is capable of generating large current swings between low and full power states. This may cause voltages on power planes to sag below their minimum values if bulk decoupling is not adequate. Large electrolytic bulk capacitors (C_{BULK}), help maintain the output voltage during current transients, for example coming out of an idle condition. Care must be taken in the baseboard design to ensure that the voltages provided to the processor remain within the specifications listed in [Table 7-11](#). Failure to do so can result in timing violations or reduced lifetime of the processor. For further information, refer to the appropriate Platform Design Guide (PDG).

7.1.9.3 Voltage Identification (VID)

The Voltage Identification (VID) specification for the V_{CC}, V_{SA}, V_{CCD} voltage are defined by the *VR12/IMVP7 Pulse Width Modulation Specification*. The reference voltage or the VID setting is set via the SVID communication bus between the processor and the voltage regulator controller chip. The VID settings are the nominal voltages to be delivered to the processor's V_{CC}, V_{SA}, V_{CCD} lands. [Table 7-3](#) specifies the reference voltage level corresponding to the VID value transmitted over serial VID. The VID codes will change due to temperature and/or current load changes in order to minimize the power and to maximize the performance of the part. The specifications are set so that a voltage regulator can operate with all supported frequencies.

Individual processor VID values may be calibrated during manufacturing such that two processor units with the same core frequency may have different default VID settings.

The processor uses voltage identification signals to support automatic selection of V_{CC}, V_{SA}, and V_{CCD} power supply voltages. If the processor socket is empty (SKTOCC_N high), or a “not supported” response is received from the SVID bus, then the voltage regulation circuit cannot supply the voltage that is requested, the voltage regulator must disable itself or not power on. Vout MAX register (30h) is programmed by the processor to set the maximum supported VID code and if the programmed VID code is



higher than the VID supported by the VR, then VR will respond with a “not supported” acknowledgement. See the *VR12/IMVP7 Pulse Width Modulation Specification* for further details.

7.1.9.3.1 SVID Commands

The processor provides the ability to operate while transitioning to a new VID setting and its associated processor voltage rails (V_{CC} , V_{SA} , and V_{CCD}). This is represented by a DC shift. It should be noted that a low-to-high or high-to-low voltage state change may result in as many VID transitions as necessary to reach the target voltage. Transitions above the maximum specified VID are not supported. The processor supports the following VR commands:

- SetVID_fast (20 mV/ μ s for V_{CC} , 10 mV/ μ s for V_{SA}/V_{CCD}),
- SetVID_slow (5 mV/ μ s for V_{CC} , 2.5 mV/ μ s for V_{SA}/V_{CCD}), and
- Slew Rate Decay (downward voltage only and it's a function of the output capacitance's time constant) commands. [Table 7-3](#) and [Table 7-21](#) includes SVID step sizes and DC shift ranges. Minimum and maximum voltages must be maintained as shown in [Table 7-11](#).

The VRM or EVRD utilized must be capable of regulating its output to the value defined by the new VID. The *VR12/IMVP7 Pulse Width Modulation Specification* contains further details.

Power source characteristics must be guaranteed to be stable whenever the supply to the voltage regulator is stable.

7.1.9.3.2 SetVID Fast Command

The SetVID-fast command contains the target VID in the payload byte. The range of voltage is defined in the VID table. The VR should ramp to the new VID setting with a fast slew rate as defined in the slew rate data register. Typically 10 to 20 mV/ μ s depending on platform, voltage rail, and the amount of decoupling capacitance.

The SetVID-fast command is preemptive, the VR interrupts its current processes and moves to the new VID. The SetVID-fast command operates on 1 VR address at a time. This command is used in the processor for package C6 fast exit and entry.

7.1.9.3.3 SetVID Slow Command

The SetVID-slow command contains the target VID in the payload byte. The range of voltage is defined in the VID table. The VR should ramp to the new VID setting with a “slow” slew rate as defined in the slow slew rate data register. The SetVID_Slow is 1/4 slower than the SetVID_fast slew rate.

The SetVID-slow command is preemptive, the VR interrupts its current processes and moves to the new VID. This is the instruction used for normal P-state voltage change. This command is used in the processor for the Intel Enhanced SpeedStep Technology transitions.

7.1.9.3.4 SetVID-Decay Command

The SetVID-Decay command is the slowest of the DVID transitions. It is only used for VID down transitions. The VR does not control the slew rate, the output voltage declines with the output load current only.

The SetVID- Decay command is preemptive, that is, the VR interrupts its current processes and moves to the new VID.

7.1.9.3.5 SVID Power State Functions: SetPS

The processor has three power state functions and these will be set seamlessly via the SVID bus using the SetPS command. Based on the power state command, the SetPS commands sends information to VR controller to configure the VR to improve efficiency, especially at light loads. For example, typical power states are:

- PS0(00h): Represents full power or active mode
- PS1(01h): Represents a light load 5 A to 20 A
- PS2(02h): Represents a very light load <5 A

The VR may change its configuration to meet the processor's power needs with greater efficiency. For example, it may reduce the number of active phases, transition from CCM (Continuous Conduction Mode) to DCM (Discontinuous Conduction Mode) mode, reduce the switching frequency or pulse skip, or change to asynchronous regulation. For example, typical power states are 00h = run in normal mode; a command of 01h= shed phases mode, and an 02h=pulse skip.

The VR may reduce the number of active phases from PS0 to PS1 or PS0 to PS2 for example. There are multiple VR design schemes that can be used to maintain a greater efficiency in these different power states, please work with your VR controller suppliers for optimizations.

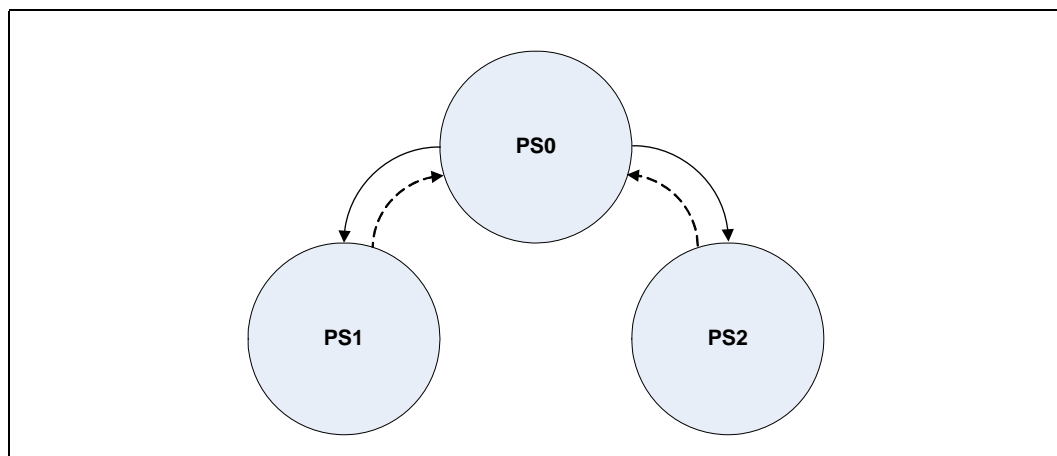
The SetPS command sends a byte that is encoded as to what power state the VR should transition to.

If a power state is not supported by the controller, the slave should acknowledge with command rejected (11b)

Note the mapping of power states 0-n will be detailed in the *VR12/IMVP7 Pulse Width Modulation Specification*.

If the VR is in a low power state and receives a SetVID command moving the VID up then the VR exits the low power state to normal mode (PS0) to move the voltage up as fast as possible. The processor must re-issue low power state (PS1 or PS2) command if it is in a low current condition at the new higher voltage. See [Figure 7-2](#) for VR power state transitions.

Figure 7-2. VR Power-State Transitions





7.1.9.3.6 SVID Voltage Rail Addressing

The processor addresses 4 different voltage rail control segments within VR12 (VCC, VCCD_01, VCCD_23, and VSA). The SVID data packet contains a 4-bit addressing code:

Table 7-2. SVID Address Usage

PWM Address (HEX)	Processor
00	V _{CC}
01	V _{SA}
02	V _{CCD_01}
03	+1 not used
04	V _{CCD_23}
05	+1 not used

Notes:

1. Check with VR vendors for determining the physical address assignment method for their controllers.
2. VR addressing is assigned on a per voltage rail basis.
3. Dual VR controllers will have two addresses with the lowest order address, always being the higher phase count.
4. For future platform flexibility, the VR controller should include an address offset, as shown with +1 not used.

Table 7-3. VR12.0 Reference Code Voltage Identification (VID) Table (Sheet 1 of 2)

HEX	VCC, VSA, VCCD	HEX	VCC, VSA, VCCD	HEX	VCC, VSA, VCCD	HEX	VCC, VSA, VCCD	HEX	VCC, VSA, VCCD	HEX	VCC, VSA, VCCD
00	0.00000	55	0.67000	78	0.84500	9B	1.02000	BE	1.19500	E1	1.37000
33	0.50000	56	0.67500	79	0.85000	9C	1.02500	BF	1.20000	E2	1.37500
34	0.50500	57	0.68000	7A	0.85500	9D	1.03000	C0	1.20500	E3	1.38000
35	0.51000	58	0.68500	7B	0.86000	9E	1.03500	C1	1.21000	E4	1.38500
36	0.51500	59	0.69000	7C	0.86500	9F	1.04000	C2	1.21500	E5	1.39000
37	0.52000	5A	0.69500	7D	0.87000	A0	1.04500	C3	1.22000	E6	1.39500
38	0.52500	5B	0.70000	7E	0.87500	A1	1.05000	C4	1.22500	E7	1.40000
39	0.53000	5C	0.70500	7F	0.88000	A2	1.05500	C5	1.23000	E8	1.40500
3A	0.53500	5D	0.71000	80	0.88500	A3	1.06000	C6	1.23500	E9	1.41000
3B	0.54000	5E	0.71500	81	0.89000	A4	1.06500	C7	1.24000	EA	1.41500
3C	0.54500	5F	0.72000	82	0.89500	A5	1.07000	C8	1.24500	EB	1.42000
3D	0.55000	60	0.72500	83	0.90000	A6	1.07500	C9	1.25000	EC	1.42500
3E	0.55500	61	0.73000	84	0.90500	A7	1.08000	CA	1.25500	ED	1.43000
3F	0.56000	62	0.73500	85	0.91000	A8	1.08500	CB	1.26000	EE	1.43500
40	0.56500	63	0.74000	86	0.91500	A9	1.09000	CC	1.26500	EF	1.44000
41	0.57000	64	0.74500	87	0.92000	AA	1.09500	CD	1.27000	F0	1.44500
42	0.57500	65	0.75000	88	0.92500	AB	1.10000	CE	1.27500	F1	1.45000
43	0.58000	66	0.75500	89	0.93000	AC	1.10500	CF	1.28000	F2	1.45500
44	0.58500	67	0.76000	8A	0.93500	AD	1.11000	D0	1.28500	F3	1.46000
45	0.59000	68	0.76500	8B	0.94000	AE	1.11500	D1	1.29000	F4	1.46500
46	0.59500	69	0.77000	8C	0.94500	AF	1.12000	D2	1.29500	F5	1.47000
47	0.60000	6A	0.77500	8D	0.95000	B0	1.12500	D3	1.30000	F6	1.47500
48	0.60500	6B	0.78000	8E	0.95500	B1	1.13000	D4	1.30500	F7	1.48000



Table 7-3. VR12.0 Reference Code Voltage Identification (VID) Table (Sheet 2 of 2)

HEX	VCC, VSA, VCCD	HEX	VCC, VSA, VCCD	HEX	VCC, VSA, VCCD	HEX	VCC, VSA, VCCD	HEX	VCC, VSA, VCCD	HEX	VCC, VSA, VCCD
49	0.61000	6C	0.78500	8F	0.96000	B2	1.13500	D5	1.31000	F8	1.48500
4A	0.61500	6D	0.79000	90	0.96500	B3	1.14000	D6	1.31500	F9	1.49000
4B	0.62000	6E	0.79500	91	0.97000	B4	1.14500	D7	1.32000	FA	1.49500
4C	0.62500	6F	0.80000	92	0.97500	B5	1.15000	D8	1.32500	FB	1.50000
4D	0.63000	70	0.80500	93	0.98000	B6	1.15500	D9	1.33000	FC	1.50500
4E	0.63500	71	0.81000	94	0.98500	B7	1.16000	DA	1.33500	FD	1.51000
4F	0.64000	72	0.81500	95	0.99000	B8	1.16500	DB	1.34000	FE	1.51500
50	0.64500	73	0.82000	96	0.99500	B9	1.17000	DC	1.34500	FF	1.52000
51	0.65000	74	0.82500	97	1.00000	BA	1.17500	DD	1.35000		
52	0.65500	75	0.83000	98	1.00500	BB	1.18000	DE	1.35500		
53	0.66000	76	0.83500	99	1.01000	BC	1.18500	DF	1.36000		
54	0.66500	77	0.84000	9A	1.01500	BD	1.19000	E0	1.36500		

Notes:

1. 00h = Off State
2. VID Range HEX 01-32 are not used by the processor.
3. For VID Ranges supported see [Table 7-11](#).
4. VCCD is a fixed voltage of 1.35 V or 1.5 V.

7.1.10 Reserved or Unused Signals

All Reserved (RSVD) signals must not be connected. Connection of these signals to V_{CC}, V_{TTA}, V_{TTD}, V_{CCD}, V_{CCPLL}, V_{SS}, or to any other signal (including each other) can result in component malfunction or incompatibility with future processors. See [Chapter 8, “Processor Land Listing”](#) for a land listing of the processor and the location of all Reserved signals.

For reliable operation, always connect unused inputs or bi-directional signals to an appropriate signal level. Unused active high inputs should be connected through a resistor to ground (V_{SS}). Unused outputs maybe left unconnected; however, this may interfere with some Test Access Port (TAP) functions, complicate debug probing, and prevent boundary scan testing. A resistor must be used when tying bi-directional signals to power or ground. When tying any signal to power or ground, a resistor will also allow for system testability. Resistor values should be within ± 20% of the impedance of the baseboard trace, unless otherwise noted in the appropriate platform design guidelines.

7.2 Signal Group Summary

Signals are grouped by buffer type and similar characteristics as listed in [Table 7-5](#). The buffer type indicates which signaling technology and specifications apply to the signals.

Table 7-4. Signal Description Buffer Types (Sheet 1 of 2)

Signal	Description
Analog	Analog reference or output. May be used as a threshold voltage or for buffer compensation
Asynchronous ¹	Signal has no timing relationship with any system reference clock.
CMOS	CMOS buffers: 1.05 V or 1.5 V tolerant



Table 7-4. Signal Description Buffer Types (Sheet 2 of 2)

Signal	Description
DDR3	DDR3 buffers: 1.5 V and 1.35 V tolerant
DMI2	Direct Media Interface Gen 2 signals. These signals are compatible with PCI Express* 2.0 and 1.0 Signaling Environment AC Specifications.
Intel QPI	Current-mode 6.4 GT/s and 8.0 GT/s forwarded-clock Intel QuickPath Interconnect signaling
Open Drain CMOS	Open Drain CMOS (ODCMOS) buffers: 1.05 V tolerant
PCI Express*	PCI Express* interface signals. These signals are compatible with PCI Express* 3.0 Signalling Environment AC Specifications and are AC coupled. The buffers are not 3.3-V tolerant. Refer to the PCIe* specification.
Reference	Voltage reference signal.
SSTL	Source Series Terminated Logic (JEDEC SSTL_15)

Notes:

1. Qualifier for a buffer type.

Table 7-5. Signal Groups (Sheet 1 of 3)

Differential/Single Ended	Buffer Type	Signals ¹
DDR3 Reference Clocks²		
Differential	SSTL Output	DDR{0/1/2/3}_CLK_D[N/P][3:0]
DDR3 Command Signals²		
Single ended	SSTL Output	DDR{0/1/2/3}_BA[2:0] DDR{0/1/2/3}_CAS_N DDR{0/1/2/3}_MA[15:00] DDR{0/1/2/3}_MA_PAR DDR{0/1/2/3}_RAS_N DDR{0/1/2/3}_WE_N
	CMOS1.5v Output	DDR_RESET_C[01/23]_N
DDR3 Control Signals²		
Single ended	CMOS1.5v Output	DDR{0/1/2/3}_CS_N[9:0] DDR{0/1/2/3}_ODT[5:0] DDR{0/1/2/3}_CKE[5:0]
	Reference Output	DDR_VREFDOTX_C[01/23]
	Reference Input	DDR_VREFDQRX_C[01/23] DDR{01/23}_RCOMP[2:0]
DDR3 Data Signals²		
Differential	SSTL Input/Output	DDR{0/1/2/3}_DQS_D[N/P][17:00]
Single ended	SSTL Input/Output	DDR{0/1/2/3}_DQ[63:00] DDR{0/1/2/3}_ECC[7:0]
	SSTL Input	DDR{0/1/2/3}_PAR_ERR_N
DDR3 Miscellaneous Signals²		
Single ended	CMOS1.5v Input	DRAM_PWR_OK_C[01/23]



Table 7-5. Signal Groups (Sheet 2 of 3)

Differential/Single Ended	Buffer Type	Signals ¹
PCI Express* Port 1, 2, & 3 Signals		
Differential	PCI Express* Input	PE1A_RX_D[N/P][3:0] PE1B_RX_D[N/P][7:4] PE2A_RX_D[N/P][3:0] PE2B_RX_D[N/P][7:4] PE2C_RX_D[N/P][11:8] PE2D_RX_D[N/P][15:12] PE3A_RX_D[N/P][3:0] PE3B_RX_D[N/P][7:4] PE3C_RX_D[N/P][11:8] PE3D_RX_D[N/P][15:12]
Differential	PCI Express* Output	PE1A_TX_D[N/P][3:0] PE1B_TX_D[N/P][7:4] PE2A_TX_D[N/P][3:0] PE2B_TX_D[N/P][7:4] PE2C_TX_D[N/P][11:8] PE2D_TX_D[N/P][15:12] PE3A_TX_D[N/P][3:0] PE3B_TX_D[N/P][7:4] PE3C_TX_D[N/P][11:8] PE3D_TX_D[N/P][15:12]
PCI Express* Miscellaneous Signals		
Single ended	Analog Input	PE_RBIAS_SENSE
	Reference Input/Output	PE_RBIAS PE_VREF_CAP
DMI2/PCI Express* Signals		
Differential	DMI2 Input	DMI_RX_D[N/P][3:0]
	DMI2 Output	DMI_TX_D[N/P][3:0]
Intel® QuickPath Interconnect (QPI) Signals		
Differential	Intel QPI Input	QPI{0/1}_DRX_D[N/P][19:00] QPI{0/1}_CLKRX_D[N/P]
	Intel QPI Output	QPI{0/1}_DTX_D[N/P][19:00] QPI{0/1}_CLKTX_D[N/P]
Single ended	Analog Input	QPI_RBIAS_SENSE
	Analog Input/Output	QPI_RBIAS
Platform Environmental Control Interface (PECI)		
Single ended	PECI	PECI
System Reference Clock (BCLK{0/1})		
Differential	CMOS1.05v Input	BCLK{0/1}_D[N/P]
SMBus		
Single ended	Open Drain CMOS Input/Output	DDR_SCL_C{01/23} DDR_SDA_C{01/23} PEHPSCL PEHPSDA

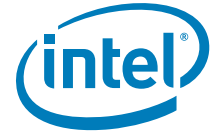


Table 7-5. Signal Groups (Sheet 3 of 3)

Differential/Single Ended	Buffer Type	Signals ¹
JTAG & TAP Signals		
Single ended	CMOS1.05V Input	TCK, TDI, TMS, TRST_N
	CMOS1.05V Input/Output	PREQ_N
	CMOS1.05V Output	PRDY_N
	Open Drain CMOS Input/Output	BPM_N[7:0] EAR_N
	Open Drain CMOS Output	TDO
Serial VID Interface (SVID) Signals		
Single ended	CMOS1.05v Input	SVIDALERT_N
	Open Drain CMOS Input/Output	SVIDDATA
	Open Drain CMOS Output	SVIDCLK
Processor Asynchronous Sideband Signals		
Single ended	CMOS1.05v Input	BIST_ENABLE BMCINIT FRMAGENT PWRGOOD PMSYNC RESET_N SAFE_MODE_BOOT SOCKET_ID[1:0] TXT_AGENT TXT_PLTEN
	Open Drain CMOS Input/Output	CAT_ERR_N CPU_ONLY_RESET MEM_HOT_C{01/23}_N PROCHOT_N
	Open Drain CMOS Output	ERROR_N[2:0] THERMTRIP_N
Miscellaneous Signals		
N/A	Output	IVT_ID_N SKTOCC_N
Power/Other Signals		
	Power / Ground	V _{CC} , V _{TTA} , V _{TTD} , V _{CCD_01} , V _{CCD_23} , V _{CCPLL} , V _{SA} and V _{SS}
	Sense Points	VCC_SENSE VSS_VCC_SENSE VSS_VTTD_SENSE VTTD_SENSE VSA_SENSE VSS_VSA_SENSE

Notes:

1. Refer to [Section 6, “Signal Descriptions”](#) for signal description details.
2. DDR{0/1/2/3} refers to DDR3 Channel 0, DDR3 Channel 1, DDR3 Channel 2 and DDR3 Channel 3.

Table 7-6. Signals with On-Die Termination

Signal Name	Pull Up /Pull Down	Rail	Value	Units	Notes
DDR{0/1}_PAR_ERR_N	Pull Up	VCCD_01	65	Ω	
DDR{2/3}_PAR_ERR_N	Pull Up	VCCD_23	65	Ω	
BMCINIT	Pull Down	VSS	2K	Ω	1
FRMAGENT	Pull Down	VSS	2K	Ω	1
TXT_AGENT	Pull Down	VSS	2K	Ω	1
SAFE_MODE_BOOT	Pull Down	VSS	2K	Ω	1
SOCKET_ID[1:0]	Pull Down	VSS	2K	Ω	1
BIST_ENABLE	Pull Up	VTT	2K	Ω	1
TXT_PLTEN	Pull Up	VTT	2K	Ω	1
EAR_N	Pull Up	VTT	2K	Ω	2

Notes:

1. Please refer to the applicable platform design guide to change the default states of these signals.
2. Refer to [Table 7-20](#) for details on the R_{ON} (Buffer on Resistance) value for this signal.

7.3 Power-On Configuration (POC) Options

Several configuration options can be configured by hardware. The processor samples its hardware configuration at reset, on the active-to-inactive transition of RESET_N, or upon assertion of PWRGOOD (inactive-to-active transition). For specifics on these options, please refer to [Table 7-7](#).

The sampled information configures the processor for subsequent operation. These configuration options cannot be changed except by another reset transition of the latching signal (RESET_N or PWRGOOD).

Table 7-7. Power-On Configuration Option Lands

Configuration Option	Land Name	Notes
Output tri state	PROCHOT_N	1
Execute BIST (Built-In Self Test)	BIST_ENABLE	2
Enable Service Processor Boot Mode	BMCINIT	3
Enable Intel TXT Platform	TXT_PLTEN	3
Power-up Sequence Halt for ITP configuration	EAR_N	3
Enable Bootable Firmware Agent	FRMAGENT	3
Enable Intel TXT Agent	TXT_AGENT	3
Enable Safe Mode Boot	SAFE_MODE_BOOT	3
Configure Socket ID	SOCKET_ID[1:0]	3

Notes:

1. Output tri-state option enables Fault Resilient Booting (FRB), for FRB details see [Section 7.4](#). The signal used to latch PROCHOT_N for enabling FRB mode is RESET_N.
2. BIST_ENABLE is sampled at RESET_N de-assertion and CPU_ONLY_RESET de-assertion (on the falling edge).
3. This signal is sampled after PWRGOOD assertion.



7.4 Fault Resilient Booting (FRB)

The processor supports both socket and core level Fault Resilient Booting (FRB), which provides the ability to boot the system as long as there is one processor functional in the system. One limitation to socket level FRB is that the system cannot boot if the legacy socket that connects to an active PCH becomes unavailable since this is the path to the system BIOS. See [Table 7-8](#) for a list of output tri-state FRB signals.

Socket level FRB will tri-state processor outputs via the PROCHOT_N signal. Assertion of the PROCHOT_N signal through RESET_N de-assertion will tri-state processor outputs. Note, that individual core disabling is also supported for those cases where disabling the entire package is not desired.

The processor extends the FRB capability to the core granularity by maintaining a register in the uncore so that BIOS or another entity can disable one or more specific processor cores.

Table 7-8. Fault Resilient Booting (Output Tri-State) Signals

Output Tri-State Signal Groups	Signals
Intel QPI	QPI0_CLKTX_DN[1:0] QPI0_CLKTX_DP[1:0] QPI0_DTX_DN[19:00] QPI0_DTX_DP[19:00] QPI1_CLKTX_DN[1:0] QPI1_CLKTX_DP[1:0] QPI1_DTX_DN[19:00] QPI1_DTX_DP[19:00]
SMBus	DDR_SCL_C01 DDR_SDA_C01 DDR_SCL_C23 DDR_SDA_C23 PEHPSCL PEHPSDA
JTAG & TAP	TDO
Processor Sideband	CAT_ERR_N ERROR_N[2:0] BPM_N[7:0] PRDY_N THERMTRIP_N PROCHOT_N PECI
SVID	SVIDCLK

7.5 Mixing Processors

Intel supports and validates and four two processor configurations only in which all processors operate with the same Intel QuickPath Interconnect frequency, core frequency, power segment, and have the same internal cache sizes. Mixing components operating at different internal clock frequencies is not supported and will not be validated by Intel. Combining processors from different power segments is also not supported.

Note: Processors within a system must operate at the same frequency per bits [15:8] of the FLEX_RATIO MSR (Address: 194h); however this does not apply to frequency transitions initiated due to thermal events, Extended HALT, Enhanced Intel SpeedStep



Technology transitions signal. Please refer to the *Intel® 64 and IA-32 Architectures Software Developer's Manual (SDM) Volumes 1, 2, and 3* for details on the FLEX_RATIO MSR and setting the processor core frequency.

Not all operating systems can support dual processors with mixed frequencies. Mixing processors of different steppings but the same model (as per CPUID instruction) is supported provided there is no more than one stepping delta between the processors, for example, S and S+1.

S and S+1 is defined as mixing of two CPU steppings in the same platform where one CPU is S (stepping) = CPUID.(EAX=01h):EAX[3:0], and the other is S+1 = CPUID.(EAX=01h):EAX[3:0]+1. The stepping ID is found in EAX[3:0] after executing the CPUID instruction with Function 01h.

Details regarding the CPUID instruction are provided in the *AP-485, Intel® Processor Identification and the CPUID Instruction* application note. Also refer to the *Intel® Xeon® Processor E5 Product Family Specification Update*.

7.6 Flexible Motherboard Guidelines (FMB)

The Flexible Motherboard (FMB) guidelines are estimates of the maximum values the processor will have over certain time periods. The values are only estimates and actual specifications for future processors may differ. Processors may or may not have specifications equal to the FMB value in the foreseeable future. System designers should meet the FMB values to ensure their systems will be compatible with future processors.

7.7 Absolute Maximum and Minimum Ratings

Table 7-9 specifies absolute maximum and minimum ratings. At conditions outside functional operation condition limits, but within absolute maximum and minimum ratings, neither functionality nor long-term reliability can be expected. If a device is returned to conditions within functional operation limits after having been subjected to conditions outside these limits, but within the absolute maximum and minimum ratings, the device may be functional, but with its lifetime degraded depending on exposure to conditions exceeding the functional operation condition limits.

Although the processor contains protective circuitry to resist damage from Electro-Static Discharge (ESD), precautions should always be taken to avoid high static voltages or electric fields.

Table 7-9. Processor Absolute Minimum and Maximum Ratings

Symbol	Parameter	Min	Max	Unit
V _{CC}	Processor core voltage with respect to V _{SS}	-0.3	1.4	V
V _{CCPLL}	Processor PLL voltage with respect to V _{SS}	-0.3	2.0	V
V _{CCD}	Processor IO supply voltage for DDR3 (standard voltage) with respect to V _{SS}	-0.3	1.85	V
V _{CCD}	Processor IO supply voltage for DDR3L (low Voltage) with respect to V _{SS}	-0.3	1.7	V
V _{SA}	Processor SA voltage with respect to V _{SS}	-0.3	1.4	V
V _{TTA} V _{TTD}	Processor analog IO voltage with respect to V _{SS}	-0.3	1.4	V



Notes:

1. For functional operation, all processor electrical, signal quality, mechanical, and thermal specifications must be satisfied.
2. Overshoot and undershoot voltage guidelines for input, output, and I/O signals are outlined in [Section 7.9.5](#). Excessive overshoot or undershoot on any signal will likely result in permanent damage to the processor.

7.7.1 Storage Conditions Specifications

Environmental storage condition limits define the temperature and relative humidity limits to which the device is exposed to while being stored in a Moisture Barrier Bag. The specified storage conditions are for component level prior to board attach (see notes in [Table 7-10](#) for post board attach limits).

[Table 7-10](#) specifies absolute maximum and minimum storage temperature limits which represent the maximum or minimum device condition beyond which damage, latent or otherwise, may occur. The table also specifies sustained storage temperature, relative humidity, and time-duration limits. These limits specify the maximum or minimum device storage conditions for a sustained period of time. At conditions outside sustained limits, but within absolute maximum and minimum ratings, quality & reliability may be affected.

Table 7-10. Storage Condition Ratings

Symbol	Parameter	Min	Max	Unit
T _{absolute storage}	The minimum/maximum device storage temperature beyond which damage (latent or otherwise) may occur when subjected to for any length of time.	-25	125	°C
T _{sustained storage}	The minimum/maximum device storage temperature for a sustained period of time.	-5	40	°C
T _{short term storage}	The ambient storage temperature (in shipping media) for a short period of time.	-20	85	°C
RH _{sustained storage}	The maximum device storage relative humidity for a sustained period of time.	60% @ 24		°C
Time _{sustained storage}	A prolonged or extended period of time: typically associated with sustained storage conditions Unopened bag, includes 6 months storage time by customer.	0	30	months
Time _{short term storage}	A short period of time (in shipping media).	0	72	hours

Notes:

1. Storage conditions are applicable to storage environments only. In this scenario, the processor must not receive a clock, and no lands can be connected to a voltage bias. Storage within these limits will not affect the long-term reliability of the device. For functional operation, please refer to the processor case temperature specifications.
2. These ratings apply to the Intel component and do not include the tray or packaging.
3. Failure to adhere to this specification can affect the long-term reliability of the processor.
4. Non-operating storage limits post board attach: Storage condition limits for the component once attached to the application board are not specified. Intel does not conduct component level certification assessments post board attach given the multitude of attach methods, socket types and board types used by customers. Provided as general guidance only, Intel board products are specified and certified to meet the following temperature and humidity limits (Non-Operating Temperature Limit: -40°C to 70°C & Humidity: 50% to 90%, non condensing with a maximum wet bulb of 28°C).
5. Device storage temperature qualification methods follow JEDEC High and Low Temperature Storage Life Standards: *JESD22-A119* (low temperature) and *JESD22-A103* (high temperature).



7.8 DC Specifications

DC specifications are defined at the processor pads, unless otherwise noted.

DC specifications are only valid while meeting specifications for case temperature (T_{CASE} specified in [Section 5](#)), clock frequency, and input voltages. Care should be taken to read all notes associated with each specification.



7.8.1 Voltage and Current Specifications

Table 7-11. Voltage Specification

Symbol	Parameter	Voltage Plane	Min	Typ	Max	Unit	Notes ¹
V _{CC} VID	V _{CC} VID Range		0.6		1.35	V	2, 3
V _{CC}	Core Voltage (Launch - FMB)	V _{CC}	See Table 7-13, Table 7-14 and Figure 7-3, Figure 7-4			V	3, 4, 7, 8, 12, 14, 18
V _{VID_STEP} (V _{CC} , V _{SA} , V _{CCD})	VID step size during a transition			5.0		mV	10
V _{CCPLL}	PLL Voltage	V _{CCPLL}	0.955*V _{CCPLL_TYP}	1.8	1.045*V _{CCPLL_TYP}	V	11, 12, 13, 17
V _{CCD} (V _{CCD_01} , V _{CCD_23})	I/O Voltage for DDR3 (Standard Voltage)	V _{CCD}	0.95*V _{CCD_TYP}	1.5	1.05*V _{CCD_TYP}	V	11, 13, 14, 16, 17
V _{CCD} (V _{CCD_01} , V _{CCD_23})	I/O Voltage for DDR3L (Low Voltage)	V _{CCD}	0.95*V _{CCD_TYP}	1.35	1.075*V _{CCD_TYP}	V	11, 13, 14, 16, 17
V _{TT} (V _{TTA} , V _{TTD})	Uncore Voltage (Launch - FMB)	V _{TT}	0.957*V _{TT_TYP}	1.05	1.043*V _{TT_TYP}	V	3, 5, 9, 12, 13
V _{SA_VID}	V _{SA} VID Range	V _{SA}	0.6	0.965	1.20	V	2, 3, 14, 15
V _{SA}	System Agent Voltage (Launch - FMB)	V _{SA}	V _{SA_VID} - 0.064	V _{SA_VID}	V _{SA_VID} + 0.064	V	3, 6, 12, 14, 19

Notes:

- Unless otherwise noted, all specifications in this table apply to all processors. These specifications are based on final silicon characterization.
- Individual processor VID values may be calibrated during manufacturing such that two devices at the same speed may have different settings.
- These voltages are targets only. A variable voltage source should exist on systems in the event that a different voltage is required.
- The V_{CC} voltage specification requirements are measured across the remote sense pin pairs (V_{CC_SENSE} and V_{SS_VCC_SENSE}) on the processor package. Voltage measurement should be taken with a DC to 100 MHz bandwidth oscilloscope limit (or DC to 20 MHz for older model oscilloscopes), using a 1.5 pF maximum probe capacitance, and 1MΩ minimum impedance. The maximum length of the ground wire on the probe should be less than 5 mm to ensure external noise from the system is not coupled in the scope probe.
- The V_{TTA} and V_{TTD} voltage specification requirements are measured across the remote sense pin pairs (V_{TTD_SENSE} and V_{SS_VTTD_SENSE}) on the processor package. Voltage measurement should be taken with a DC to 100 MHz bandwidth oscilloscope limit (or DC to 20 MHz for older model oscilloscopes), using a 1.5 pF maximum probe capacitance, and 1MΩ minimum impedance. The maximum length of the ground wire on the probe should be less than 5 mm to ensure external noise from the system is not coupled in the scope probe.
- The V_{SA} voltage specification requirements are measured across the remote sense pin pairs (V_{SA_SENSE} and V_{SS_VSA_SENSE}) on the processor package. Voltage measurement should be taken with a DC to 100 MHz bandwidth oscilloscope limit (or DC to 20 MHz for older model oscilloscopes), using a 1.5 pF maximum probe capacitance, and 1MΩ minimum impedance. The maximum length of the ground wire on the probe should be less than 5 mm to ensure external noise from the system is not coupled in the scope probe.
- For the 8/6-core processor refer to Table 7-13 and corresponding Figure 7-3. For the 4/2-core processor refer to Table 7-14 and corresponding Figure 7-4. The processor should not be subjected to any static V_{CC} level that exceeds the V_{CC_MAX} associated with any particular current. Failure to adhere to this specification can shorten processor lifetime.
- Minimum V_{CC} and maximum I_{CC} are specified at the maximum processor case temperature (T_{CASE}) shown in Section 5, "Thermal Management Specifications". I_{CC_MAX} is specified at the relative V_{CC_MAX} point on the V_{CC} load line. The processor is capable of drawing I_{CC_MAX} for up to 5 seconds. Refer to Figure 7-5 for further details on the average processor current draw over various time durations.
- The processor should not be subjected to any static V_{TTA}, V_{TTD} level that exceeds the V_{TT_MAX} associated with any particular current. Failure to adhere to this specification can shorten processor lifetime.
- This specification represents the V_{CC} reduction or V_{CC} increase due to each VID transition, see Section 7.1.9.3, "Voltage Identification (VID)".
- Baseboard bandwidth is limited to 20 MHz.
- FMB is the flexible motherboard guidelines. See Section 7.6 for FMB details.
- DC + AC + Ripple = Total Tolerance
- For Power State Functions see Section 7.1.9.3.5.
- V_{SA_VID} does not have a loadline, the output voltage is expected to be the VID value.



16. V_{CCD} tolerance at processor pins. Tolerance for VR at remote sense is $\pm 3.3\% \cdot V_{CCD}$.
17. The V_{CCPLL} , V_{CCD01} , V_{CCD23} voltage specification requirements are measured across vias on the platform. Choose V_{CCPLL} , V_{CCD01} , or V_{CCD23} vias close to the socket and measure with a DC to 100 MHz bandwidth oscilloscope limit (or DC to 20 MHz for older model oscilloscopes), using 1.5 pF maximum probe capacitance, and 1M Ω minimum impedance. The maximum length of the ground wire on the probe should be less than 5 mm to ensure external noise from the system is not coupled in the scope probe.
18. VCC has a Vboot setting of 0.0 V and is not included in the PWRGOOD indication. Refer to the *VR12/IMVP7 Pulse Width Modulation Specification*.
19. VSA has a Vboot setting of 0.9 V. Refer to the *VR12/IMVP7 Pulse Width Modulation Specification*.

Table 7-12. Processor Current Specifications

Parameter Symbol and Definition	Processor TDP / Core Count	TDC (A)	Max (A)	Notes ¹
I_{TT} I/O Termination Supply, Processor Current on V_{TTA}/V_{TTD}	All Intel® Xeon® processor E5-1600/E5-2600/E5-4600 product families	20	24	2, 3, 5, 6
I_{SA} System Agent Supply, Processor Current on V_{SA}		20	24	
I_{CCD_01} DDR3 Supply, Processor Current V_{CCD_01}		3	4	
I_{CCD_23} DDR3 Supply, Processor Current V_{CCD_23}		3	4	
I_{CCPLL} PLL Supply, Processor Current on V_{CCPLL}		2	2	
$I_{CCD_01_S3}$ $I_{CCD_23_S3}$ DDR3 Supply, Processor Current on V_{CCD_01}/V_{CCD_23} in System S3 Standby State			--	1
I_{CC} Core Supply, Processor Current on V_{CC}	8-core/6-core			
	150 W 8-core	155	185	2, 5, 6
	135 W 8-core	135	165	
	130 W 6-core, 6-core 1S WS and 8-core			
	115 W 8-core			
	95 W 6-core, 8-core and LV95W-8C	115	135	
	70 W 8-core and LV70W-8C	80	100	
	60 W 6-core	70	85	
	4-core/2-core			
	130 W 4-core and 4-core 1S WS	115	150	2, 5, 6
	95 W 4-core	115	135	
80 W 2-core and 4-core	80	100		

Notes:

1. Unless otherwise noted, all specifications in this table apply to all processors. These specifications are based on final silicon characterization.
2. Launch to FMB, this is the flexible motherboard guidelines. See [Section 7.6](#) for FMB details.
3. I_{CC_TDC} (Thermal Design Current) is the sustained (DC equivalent) current that the processor is capable of drawing indefinitely and should be used for the voltage regulator thermal assessment. The voltage regulator is responsible for monitoring its temperature and asserting the necessary signal to inform the processor of a thermal excursion. Please refer to the *VR12/IMVP7 Pulse Width Modulation Specification* for further details.
4. Specification is at $T_{CASE} = 50^{\circ}C$. Characterized by design (not tested).
5. $I_{CCD_01_MAX}$ and $I_{CCD_23_MAX}$ refers only to the processor's current draw and does not account for the current consumption by the memory devices.
6. Minimum V_{CC} and maximum I_{CC} are specified at the maximum processor case temperature (T_{CASE}) shown in [Section 5](#), "Thermal Management Specifications". I_{CC_MAX} is specified at the relative V_{CC_MAX} point on the V_{CC} load line. The processor is



capable of drawing I_{CC_MAX} for up to 5 seconds. Refer to Figure 7-5 for further details on the average processor current draw over various time durations.

Table 7-13. 8/6 Core: Processor V_{CC} Static and Transient Tolerance

I_{CC} (A)	V_{CC_MAX} (V)	V_{CC_TYP} (V)	V_{CC_MIN} (V)	Notes
0	VID + 0.015	VID - 0.000	VID - 0.015	1,2,3,4,5,6
5	VID + 0.011	VID - 0.004	VID - 0.019	1,2,3,4,5,6
10	VID + 0.007	VID - 0.008	VID - 0.023	1,2,3,4,5,6
15	VID + 0.003	VID - 0.012	VID - 0.027	1,2,3,4,5,6
19	VID + 0.000	VID - 0.015	VID - 0.030	1,2,3,4,5,6
25	VID - 0.005	VID - 0.020	VID - 0.035	1,2,3,4,5,6
30	VID - 0.009	VID - 0.024	VID - 0.039	1,2,3,4,5,6
35	VID - 0.013	VID - 0.028	VID - 0.043	1,2,3,4,5,6
40	VID - 0.017	VID - 0.032	VID - 0.047	1,2,3,4,5,6
45	VID - 0.021	VID - 0.036	VID - 0.051	1,2,3,4,5,6
50	VID - 0.025	VID - 0.040	VID - 0.055	1,2,3,4,5,6
55	VID - 0.029	VID - 0.044	VID - 0.059	1,2,3,4,5,6
60	VID - 0.033	VID - 0.048	VID - 0.063	1,2,3,4,5,6
65	VID - 0.037	VID - 0.052	VID - 0.067	1,2,3,4,5,6
70	VID - 0.041	VID - 0.056	VID - 0.071	1,2,3,4,5,6
75	VID - 0.045	VID - 0.060	VID - 0.075	1,2,3,4,5,6
80	VID - 0.049	VID - 0.064	VID - 0.079	1,2,3,4,5,6
85	VID - 0.053	VID - 0.068	VID - 0.083	1,2,3,4,5,6
90	VID - 0.057	VID - 0.072	VID - 0.087	1,2,3,4,5,6
95	VID - 0.061	VID - 0.076	VID - 0.091	1,2,3,4,5,6
100	VID - 0.065	VID - 0.080	VID - 0.095	1,2,3,4,5,6
105	VID - 0.069	VID - 0.084	VID - 0.099	1,2,3,4,5,6
110	VID - 0.073	VID - 0.088	VID - 0.103	1,2,3,4,5,6
115	VID - 0.077	VID - 0.092	VID - 0.107	1,2,3,4,5,6
120	VID - 0.081	VID - 0.096	VID - 0.111	1,2,3,4,5,6
125	VID - 0.085	VID - 0.100	VID - 0.115	1,2,3,4,5,6
130	VID - 0.089	VID - 0.104	VID - 0.119	1,2,3,4,5,6
135	VID - 0.093	VID - 0.108	VID - 0.123	1,2,3,4,5,6
140	VID - 0.097	VID - 0.112	VID - 0.127	1,2,3,4,5,6
145	VID - 0.101	VID - 0.116	VID - 0.131	1,2,3,4,5,6
150	VID - 0.105	VID - 0.120	VID - 0.135	1,2,3,4,5,6
155	VID - 0.109	VID - 0.124	VID - 0.139	1,2,3,4,5,6
160	VID - 0.113	VID - 0.128	VID - 0.143	1,2,3,4,5,6
165	VID - 0.117	VID - 0.132	VID - 0.147	1,2,3,4,5,6
170	VID - 0.121	VID - 0.136	VID - 0.151	1,2,3,4,5,6
175	VID - 0.125	VID - 0.140	VID - 0.155	1,2,3,4,5,6
180	VID - 0.129	VID - 0.144	VID - 0.159	1,2,3,4,5,6
185	VID - 0.133	VID - 0.148	VID - 0.163	1,2,3,4,5,6

Notes:

1. The loadline specification includes both static and transient limits.



2. This table is intended to aid in reading discrete points on graph in [Figure 7-3](#).
3. The loadlines specify voltage limits at the die measured at the VCC_SENSE and VSS_VCC_SENSE lands. Voltage regulation feedback for voltage regulator circuits must also be taken from processor VCC_SENSE and VSS_VCC_SENSE lands. Refer to the *VR12/IMVP7 Pulse Width Modulation Specification* for loadline guidelines and VR implementation details.
4. The Vcc_min and Vcc_max loadlines represent static and transient limits. Please see [Section 6](#) for Vcc Overshoot specifications.
5. The Adaptive Loadline Positioning slope is 0.8 mΩ.
6. The 8/6-core Icc ranges are as follows:
 - 0-185 A for 150 W processor
 - 0-165 A for 135 W, 130 W, 115 W processors
 - 0-135 A for 95 W, LV95W-8C processors
 - 0-100 A for 70 W, LV70W-8C processors
 - 0-85 A for 60 W processors

Figure 7-3. 8/6-Core: V_{CC} Static and Transient Tolerance Loadlines

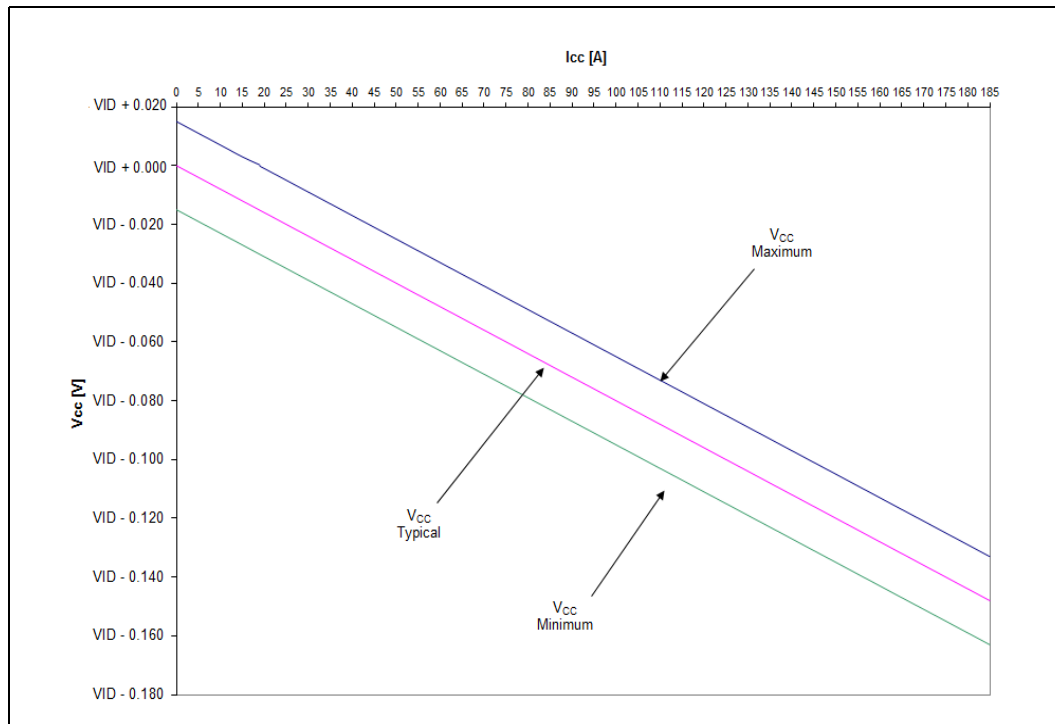


Table 7-14. 4/2-Core: Processor V_{CC} Static and Transient Tolerance (Sheet 1 of 2)

I _{CC} (A)	V _{CC_MAX} (V)	V _{CC_TYP} (V)	V _{CC_MIN} (V)	Notes
0	VID + 0.015	VID - 0.000	VID - 0.015	1,2,3,4,5,6
5	VID + 0.011	VID - 0.004	VID - 0.019	1,2,3,4,5,6
10	VID + 0.007	VID - 0.008	VID - 0.023	1,2,3,4,5,6
15	VID + 0.003	VID - 0.012	VID - 0.027	1,2,3,4,5,6
19	VID + 0.000	VID - 0.015	VID - 0.030	1,2,3,4,5,6
25	VID - 0.005	VID - 0.020	VID - 0.035	1,2,3,4,5,6
30	VID - 0.009	VID - 0.024	VID - 0.039	1,2,3,4,5,6
35	VID - 0.013	VID - 0.028	VID - 0.043	1,2,3,4,5,6
40	VID - 0.017	VID - 0.032	VID - 0.047	1,2,3,4,5,6
45	VID - 0.021	VID - 0.036	VID - 0.051	1,2,3,4,5,6
50	VID - 0.025	VID - 0.040	VID - 0.055	1,2,3,4,5,6
55	VID - 0.029	VID - 0.044	VID - 0.059	1,2,3,4,5,6



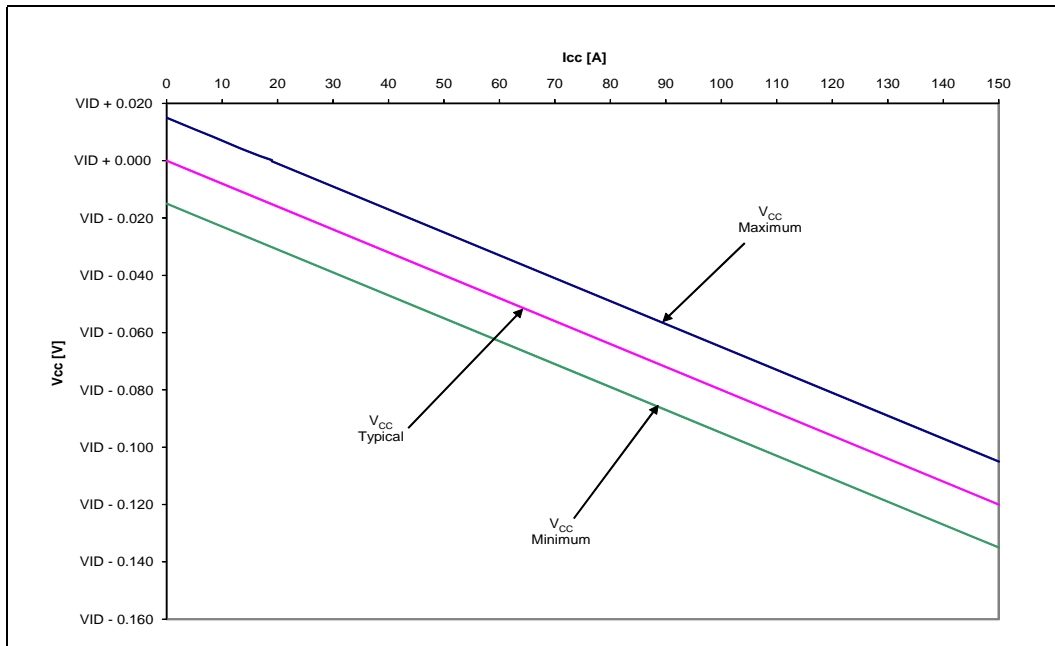
Table 7-14. 4/2-Core: Processor V_{CC} Static and Transient Tolerance (Sheet 2 of 2)

I _{CC} (A)	V _{CC_MAX} (V)	V _{CC_TYP} (V)	V _{CC_MIN} (V)	Notes
60	VID - 0.033	VID - 0.048	VID - 0.063	1,2,3,4,5,6
65	VID - 0.037	VID - 0.052	VID - 0.067	1,2,3,4,5,6
70	VID - 0.041	VID - 0.056	VID - 0.071	1,2,3,4,5,6
75	VID - 0.045	VID - 0.060	VID - 0.075	1,2,3,4,5,6
80	VID - 0.049	VID - 0.064	VID - 0.079	1,2,3,4,5,6
85	VID - 0.053	VID - 0.068	VID - 0.083	1,2,3,4,5,6
90	VID - 0.057	VID - 0.072	VID - 0.087	1,2,3,4,5,6
95	VID - 0.061	VID - 0.076	VID - 0.091	1,2,3,4,5,6
100	VID - 0.065	VID - 0.080	VID - 0.095	1,2,3,4,5,6
105	VID - 0.069	VID - 0.084	VID - 0.099	1,2,3,4,5,6
110	VID - 0.073	VID - 0.088	VID - 0.103	1,2,3,4,5,6
115	VID - 0.077	VID - 0.092	VID - 0.107	1,2,3,4,5,6
120	VID - 0.081	VID - 0.096	VID - 0.111	1,2,3,4,5,6
125	VID - 0.085	VID - 0.100	VID - 0.115	1,2,3,4,5,6
130	VID - 0.089	VID - 0.104	VID - 0.119	1,2,3,4,5,6
135	VID - 0.093	VID - 0.108	VID - 0.123	1,2,3,4,5,6
140	VID - 0.097	VID - 0.112	VID - 0.127	1,2,3,4,5,6
145	VID - 0.101	VID - 0.116	VID - 0.131	1,2,3,4,5,6
150	VID - 0.105	VID - 0.120	VID - 0.135	1,2,3,4,5,6

Notes:

1. The loadline specification includes both static and transient limits.
2. This table is intended to aid in reading discrete points on graph in [Figure 7-4](#).
3. The loadlines specify voltage limits at the die measured at the V_{CC_sense} and V_{SS_VCC_sense} lands. Voltage regulation feedback for voltage regulator circuits must also be taken from processor V_{CC_sense} and V_{SS_VCC_sense} lands. Refer to the *VR12/IMVP7 Pulse Width Modulation Specification* for loadline guidelines and VR implementation details.
4. The V_{CC_min} and V_{CC_max} loadlines represent static and transient limits. Please see [Section 7.8.2.1, "VCC Overshoot Specifications"](#).
5. The Adaptive Loadline Positioning slope is 0.8 mΩ.
6. The 4/2-core I_{CC} ranges are as follows:
 - 0-150 A for 130 W processor
 - 0-135 A for 95 W processor
 - 0-100 A for 80 W processor

Figure 7-4. 4/2-Core: Processor V_{CC} Static and Transient Tolerance Loadlines

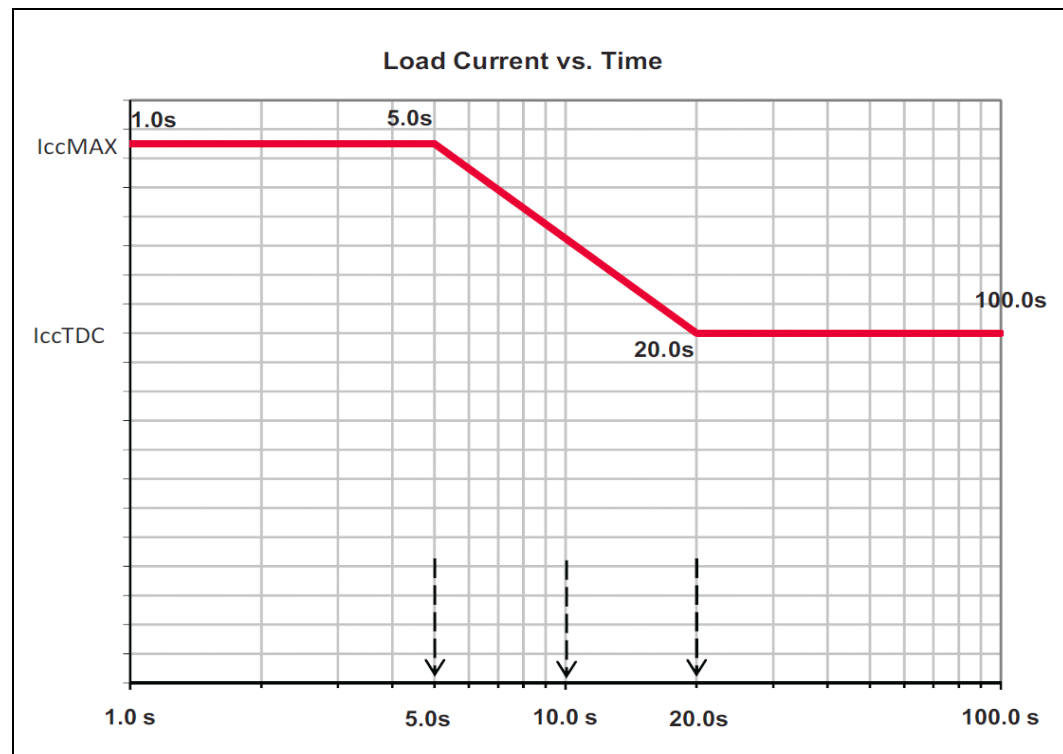




7.8.2 Die Voltage Validation

Core voltage (V_{CC}) overshoot events at the processor must meet the specifications in Table 7-15 when measured across the VCC_SENSE and VSS_VCC_SENSE lands. Overshoot events that are < 10 ns in duration may be ignored. These measurements of processor die level overshoot should be taken with a 100 MHz bandwidth limited oscilloscope.

Figure 7-5. Load Current Versus Time



Notes:

1. The peak current for *any* 5 second sample does not exceed I_{cc_max} .
2. The average current for *any* 10 second sample does not exceed the Y value at 10 seconds.
3. The average current for *any* 20 second period or greater does not exceed I_{cc_tdc} .
4. Turbo performance may be impacted by failing to meet durations specified in this graph. Ensure that the platform design can handle peak and average current based on the specification.
5. Processor or voltage regulator thermal protection circuitry should not trip for load currents greater than I_{CC_TDC} .
6. Not 100% tested. Specified by design characterization.

7.8.2.1 V_{CC} Overshoot Specifications

The processor can tolerate short transient overshoot events where V_{CC} exceeds the VID voltage when transitioning from a high-to-low current load condition. This overshoot cannot exceed $VID + V_{OS_MAX}$ (V_{OS_MAX} is the maximum allowable overshoot above VID). These specifications apply to the processor die voltage as measured across the VCC_SENSE and VSS_VCC_SENSE lands.

Table 7-15. V_{CC} Overshoot Specifications (Sheet 1 of 2)

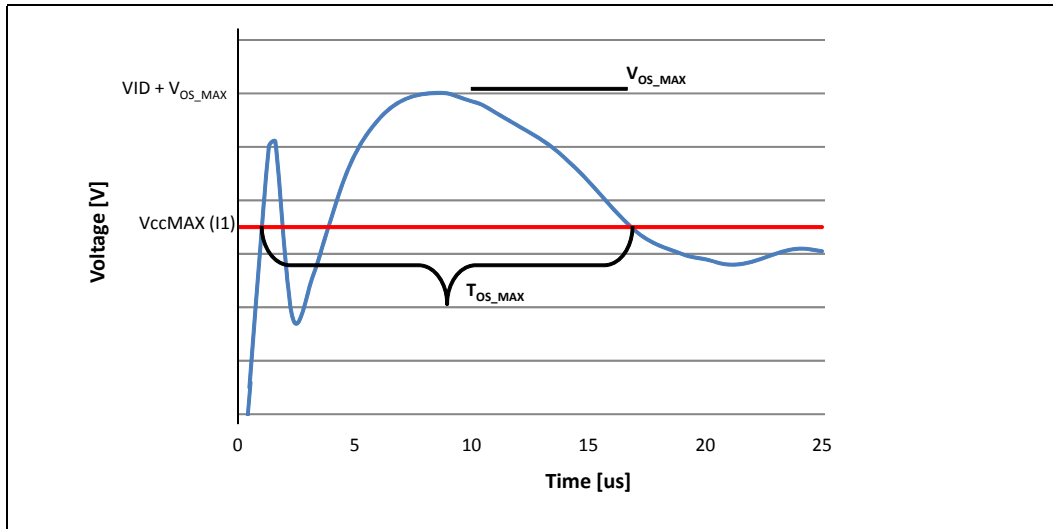
Symbol	Parameter	Min	Max	Units	Figure	Notes
V_{OS_MAX}	Magnitude of V_{CC} overshoot above VID		65	mV	7-6	



Table 7-15. V_{CC} Overshoot Specifications (Sheet 2 of 2)

Symbol	Parameter	Min	Max	Units	Figure	Notes
T_{OS_MAX}	Time duration of V_{CC} overshoot above V_{CCMAX} value at the new lighter load		25	μs	7-6	

Figure 7-6. V_{CC} Overshoot Example Waveform



Notes:

1. V_{OS_MAX} is the measured overshoot voltage.
2. T_{OS_MAX} is the measured time duration above $V_{CCMAX}(I1)$.
3. Istep: Load Release Current Step, for example, $I2$ to $I1$, where $I2 > I1$.
4. $V_{CCMAX}(I1) = VID - I1 * RLL + 15$ mV

7.8.3 Signal DC Specifications

DC specifications are defined at the processor pads, unless otherwise noted. DC specifications are only valid while meeting specifications for case temperature (T_{CASE} specified in Section 5, "Thermal Management Specifications"), clock frequency, and input voltages. Care should be taken to read all notes associated with each specification.

Table 7-16. DDR3 and DDR3L Signal DC Specifications (Sheet 1 of 2)

Symbol	Parameter	Min	Typ	Max	Units	Notes ¹
I_{IL}	Input Leakage Current	-500		+500	μA	10
Data Signals						
V_{IL}	Input Low Voltage			$0.43 * V_{CCD}$	V	2, 3
V_{IH}	Input High Voltage	$0.57 * V_{CCD}$			V	2, 4, 5
R_{ON}	DDR3 Data Buffer On Resistance	21		31	Ω	6
Data ODT	On-Die Termination for Data Signals	45 90		55 110	Ω	8
PAR_ERR_N ODT	On-Die Termination for Parity Error Signals	59		72	Ω	
Reference Clock Signals, Command, and Data Signals						



Table 7-16. DDR3 and DDR3L Signal DC Specifications (Sheet 2 of 2)

Symbol	Parameter	Min	Typ	Max	Units	Notes ¹
V _{OL}	Output Low Voltage		$(V_{CCD} / 2) * (R_{ON} / (R_{ON} + R_{VTT_TERM}))$		V	2, 7
V _{OH}	Output High Voltage		$V_{CCD} - ((V_{CCD} / 2) * (R_{ON} / (R_{ON} + R_{VTT_TERM})))$		V	2, 5, 7
Reference Clock Signal						
R _{ON}	DDR3 Clock Buffer On Resistance	21		31	Ω	6
Command Signals						
R _{ON}	DDR3 Command Buffer On Resistance	16		24	Ω	6
R _{ON}	DDR3 Reset Buffer On Resistance	25		75	Ω	6
V _{OL_CMOS1.5v}	Output Low Voltage, Signals DDR_RESET_C{01/23}_N			0.2*V _{CCD}	V	1,2
V _{OH_CMOS1.5v}	Output High Voltage, Signals DDR_RESET_C{01/23}_N	0.9*V _{CCD}			V	1,2
I _{IL_CMOS1.5v}	Input Leakage Current	-100		+100	μA	1,2
Control Signals						
R _{ON}	DDR3 Control Buffer On Resistance	21		31	Ω	6
DDR01_RCOMP[0]	COMP Resistance	128.7	130	131.3	Ω	9,12
DDR01_RCOMP[1]	COMP Resistance	25.839	26.1	26.361	Ω	9,12
DDR01_RCOMP[2]	COMP Resistance	198	200	202	Ω	9,12
DDR23_RCOMP[0]	COMP Resistance	128.7	130	131.3	Ω	9,12
DDR23_RCOMP[1]	COMP Resistance	25.839	26.1	26.361	Ω	9,12
DDR23_RCOMP[2]	COMP Resistance	198	200	202	Ω	9,12
DDR3 Miscellaneous Signals						
V _{IL}	Input Low Voltage DRAM_PWR_OK_C{01/23}			0.55*V _{CCD} D - 0.2	V	2, 3, 11, 13
V _{IH}	Input High Voltage DRAM_PWR_OK_C{01/23}	0.55*V _{CCD} D + 0.3			V	2, 4, 5, 11, 13

Notes:

1. Unless otherwise noted, all specifications in this table apply to all processor frequencies.
2. The voltage rail V_{CCD} which will be set to 1.50 V or 1.35 V nominal depending on the voltage of all DIMMs connected to the processor.
3. V_{IL} is the maximum voltage level at a receiving agent that will be interpreted as a logical low value.
4. V_{IH} is the minimum voltage level at a receiving agent that will be interpreted as a logical high value.
5. V_{IH} and V_{OH} may experience excursions above V_{CCD}. However, input signal drivers must comply with the signal quality specifications. Refer to [Section 7.9](#).
6. This is the pull down driver resistance. Refer to processor signal integrity models for I/V characteristics. Reset drive does not have a termination.
7. R_{VTT_TERM} is the termination on the DIMM and not controlled by the processor. Please refer to the applicable DIMM datasheet.
8. The minimum and maximum values for these signals are programmable by BIOS to one of the pairs.
9. COMP resistance must be provided on the system board with 1% resistors. See the applicable platform design guide for implementation details. DDR01_RCOMP[2:0] and DDR23_RCOMP[2:0] resistors are terminated to VSS.
10. Input leakage current is specified for all DDR3 signals.
11. DRAM_PWR_OK_C{01/23} must have a maximum of 30 ns rise or fall time over V_{CCD} * 0.55 + 300 mV and -200 mV and the edge must be monotonic.
12. The DDR01/23_RCOMP error tolerance is ± 15% from the compensated value.



13. DRAM_PWR_OK_C(01/23): Data Scrambling must be enabled for production environments. Disabling Data scrambling may be used for debug and testing purposes only. Operating systems with Data Scrambling off will make the configuration out of specification.

Table 7-17. PECEI DC Specifications

Symbol	Definition and Conditions	Min	Max	Units	Figure	Notes ¹
V _{In}	Input Voltage Range	-0.150	V _{TT}	V		
V _{Hysteresis}	Hysteresis	0.100 * V _{TT}		V		
V _N	Negative-edge threshold voltage	0.275 * V _{TT}	0.500 * V _{TT}	V	7-1	2
V _P	Positive-edge threshold voltage	0.550 * V _{TT}	0.725 * V _{TT}	V	7-1	2
I _{SOURCE}	High level output source V _{OH} = 0.75 * V _{TT}	-6.0		mA		
I _{Leak+}	High impedance state leakage to V _{TTD} (V _{leak} = V _{OL})	50	200	μA		3
C _{Bus}	Bus capacitance per node	N/A	10	pF		4,5
V _{Noise}	Signal noise immunity above 300 MHz	0.100 * V _{TT}	N/A	V _{p-p}		

Notes:

- V_{TTD} supplies the PECEI interface. PECEI behavior does not affect V_{TTD} min/max specification
- It is expected that the PECEI driver will take into account, the variance in the receiver input thresholds and consequently, be able to drive its output within safe limits (-0.150 V to 0.275*V_{TTD} for the low level and 0.725*V_{TTD} to V_{TTD}+0.150 V for the high level).
- The leakage specification applies to powered devices on the PECEI bus.
- One node is counted for each client and one node for the system host. Extended trace lengths might appear as additional nodes.
- Excessive capacitive loading on the PECEI line may slow down the signal rise/fall times and consequently limit the maximum bit rate at which the interface can operate.

Table 7-18. System Reference Clock (BCLK{0/1}) DC Specifications

Symbol	Parameter	Signal	Min	Max	Unit	Figure	Notes ¹
V _{BCLK_diff_ih}	Differential Input High Voltage	Differential	0.150	N/A	V	7-8	
V _{BCLK_diff_il}	Differential Input Low Voltage	Differential		-0.150	V	7-8	
V _{cross} (abs)	Absolute Crossing Point	Single Ended	0.250	0.550	V	7-7 7-9	2, 4, 7
V _{cross} (rel)	Relative Crossing Point	Single Ended	0.250 + 0.5*(V _{Havg} - 0.700)	0.550 + 0.5*(V _{Havg} - 0.700)	V	7-7	3, 4, 5
ΔV _{cross}	Range of Crossing Points	Single Ended	N/A	0.140	V	7-10	6
V _{TH}	Threshold Voltage	Single Ended	V _{cross} - 0.1	V _{cross} + 0.1	V		
I _{IL}	Input Leakage Current	N/A		1.50	μA		8
C _{pad}	Pad Capacitance	N/A	0.9	1.1	pF		

Notes:

- Unless otherwise noted, all specifications in this table apply to all processor frequencies. These specifications are specified at the processor pad.
- Crossing Voltage is defined as the instantaneous voltage value when the rising edge of BCLK{0/1}_DN is equal to the falling edge of BCLK{0/1}_DP.
- V_{Havg} is the statistical average of the VH measured by the oscilloscope.
- The crossing point must meet the absolute and relative crossing point specifications simultaneously.
- V_{Havg} can be measured directly using "Vtop" on Agilent* and "High" on Tektronix oscilloscopes.
- V_{CROSS} is defined as the total variation of all crossing voltages as defined in Note 3.
- The rising edge of BCLK{0/1}_DN is equal to the falling edge of BCLK{0/1}_DP.
- For Vin between 0 and Vih.

Table 7-19. SMBus DC Specifications (Sheet 1 of 2)

Symbol	Parameter	Min	Max	Units	Notes
V _{IL}	Input Low Voltage		0.3*V _{TT}	V	



Table 7-19. SMBus DC Specifications (Sheet 2 of 2)

Symbol	Parameter	Min	Max	Units	Notes
V _{IH}	Input High Voltage	0.7*V _{TT}		V	
V _{OL}	Output Low Voltage		0.2*V _{TT}	V	
V _{OH}	Output High Voltage		V _{TT(max)}	V	
R _{ON}	Buffer On Resistance		14	Ω	
I _L	Leakage Current Signals DDR_SCL_C{01/23}, DDR_SDA_C{01/23}	-100	+100	μA	
I _L	Leakage Current Signals PEHPSCL, PEHPSDA		+900	μA	

Table 7-20. JTAG and TAP Signals DC Specifications

Symbol	Parameter	Min	Max	Units	Notes
V _{IL}	Input Low Voltage		0.3*V _{TT}	V	
V _{IH}	Input High Voltage	0.7*V _{TT}		V	
V _{OL}	Output Low Voltage (R _{TEST} = 500 ohm)		0.12*V _{TT}	V	
V _{OH}	Output High Voltage (R _{TEST} = 500 ohm)	0.88*V _{TT}		V	
R _{ON}	Buffer On Resistance Signals BPM_N[7:0], TDO, EAR_N		14	Ω	
I _{IL}	Input Leakage Current Signals PREQ_N, TCK, TDI, TMS, TRST_N	-50	+50	μA	
I _{IL}	Input Leakage Current Signals BPM_N[7:0], TDO, EAR_N (R _{TEST} = 50 ohm)		+900	μA	
I _O	Output Current Signal PRDY_N (R _{TEST} = 500 ohm)	-1.50	+1.50	mA	
	Input Edge Rate Signals: BPM_N[7:0], EAR_N, PREQ_N, TCK, TDI, TMS, TRST_N	0.05		V/ns	1, 2

Note:

1. These signals are measured between V_{IL} and V_{IH}.
2. The signal edge rate must be met or the signal must transition monotonically to the asserted state.

Table 7-21. Serial VID Interface (SVID) DC Specifications (Sheet 1 of 2)

Symbol	Parameter	Min	Typ	Max	Units	Notes
V _{TT}	CPU I/O Voltage	V _{TT} - 3%	1.05	V _{TT} + 3%	V	
V _{IL}	Input Low Voltage Signals SVIDDATA, SVIDALERT_N			0.3*V _{TT}	V	1
V _{IH}	Input High Voltage Signals SVIDDATA, SVIDALERT_N	0.7*V _{TT}			V	1
V _{OH}	Output High Voltage Signals SVIDCLK, SVIDDATA			V _{TT(max)}	V	1



Table 7-21. Serial VID Interface (SVID) DC Specifications (Sheet 2 of 2)

Symbol	Parameter	Min	Typ	Max	Units	Notes
R _{ON}	Buffer On Resistance Signals SVIDCLK, SVIDDATA			14	Ω	2
I _{IL}	Input Leakage Current Signals SVIDCLK, SVIDDATA			±900	μA	3,4
I _{IL}	Input Leakage Current Signal SVIDALERT_N			±500	μA	3,4

Notes:

1. V_{TT} refers to instantaneous V_{TT}.
2. Measured at 0.31*V_{TT}
3. Vin between 0V and V_{TT}
4. Refer to the appropriate Platform Design Guide (PDG) for routing design guidelines.

Table 7-22. Processor Asynchronous Sideband DC Specifications

Symbol	Parameter	Min	Max	Units	Notes	
	Input Edge Rate Signals: CAT_ERR_N, MEM_HOT_C{01/23}_N, PMSYNC, PROCHOT_N, PWRGOOD, RESET_N	0.05		V/ns	4,5	
CMOS1.05v Signals						
V _{IL_CMOS1.05v}	Input Low Voltage		0.3*V _{TT}	V	1,2	
V _{IH_CMOS1.05v}	Input High Voltage	0.7*V _{TT}		V	1,2	
V _{IL_MAX}	Input Low Voltage Signal PWRGOOD		0.320	V	1,2,5,	
V _{IH_MIN}	Input High Voltage Signal PWRGOOD	0.640		V	1,2,5	
V _{OL_CMOS1.05v}	Output Low Voltage		0.12*V _{TT}	V	1,2	
V _{OH_CMOS1.05v}	Output High Voltage	0.88*V _{TT}		V	1,2	
I _{IL_CMOS1.05v}	Input Leakage Current		±50	mA	1,2	
I _{O_CMOS1.05v}	Output Current (R _{TEST} = 500 ohm)		±1.50	mA	1,2	
A _{NM_Rise}	Non-Monotonicity Amplitude, Rising Edge Signal PWRGOOD		0.135	V	5	
A _{NM_Fall}	Non-Monotonicity Amplitude, Falling Edge Signal PWRGOOD		0.165	V	5	
Open Drain CMOS (ODCMOS) Signals						
V _{IL_ODCMOS}	Input Low Voltage		0.3*V _{TT}	V	1,2	
V _{IH_ODCMOS}	Input High Voltage	0.7*V _{TT}		V	1,2	
V _{OH_ODCMOS}	Output High Voltage Signals: CAT_ERR_N, ERROR_N[2:0], THERMTRIP_N, PROCHOT_N, CPU_ONLY_RESET		V _{TT(max)}	V	1,2	
I _{OL}	Output Leakage Current, Signal MEM_HOT_C{01/23}_N		±100	mA	3	
I _{OL}	Output Leakage Current (R _{TEST} = 50 ohm)		±900	mA	3	
R _{ON}	Buffer On Resistance Signals: CAT_ERR_N, CPU_ONLY_RESET, ERROR_N[2:0], MEM_HOT_C{01/23}_N, PROCHOT_N, THERMTRIP_N			14	W	1,2

Notes:



1. These specifications This table applies to the processor sideband and miscellaneous signals specified in [Table 7-5](#).
2. Unless otherwise noted, all specifications in this table apply to all processor frequencies.
3. For V_{in} between 0 and V_{oh} . For V_{in} between 0 and V_{oh} .
4. PWRGOOD Non Monotonicity duration (T_{NM}) time is maximum 1.3 ns.
5. These are measured between V_{IL} and V_{IH} . If the edge rate specification is not met, make sure there is a monotonic edge and the edge rate is not lower than the edge rate specification for the monotonic edges. The monotonic input edge rate is 0.02 V/ns.
6. The waveform could be non-monotonic when measured at the land (near the socket at the bottom side of via) but not when observed at the pad during simulation. The waveform measured at the land could violate specifications defined at the pad. Customers could measure the land timings on their boards and then use the package length information found in the Model Usage Guidelines (MUG) which comes with the I/O model to correlate the results to the specification at the pad.

Table 7-23. Miscellaneous Signals DC Specifications

Symbol	Parameter	Min	Typical	Max	Units	Notes
IVT_ID_N Signal						
$V_{O_ABS_MAX}$	Output Absolute Max Voltage		1.10	1.80	V	1
I_O	Output Current			0	μ A	1, 3
SKTOCC_N Signal						
$V_{O_ABS_MAX}$	Output Absolute Max Voltage		3.30	3.50	V	1
I_{OMAX}	Output Max Current			1	mA	2

Notes:

1. For specific routing guidelines, see the appropriate Platform Design Guide (PDG) for details.
2. See the appropriate Platform Design Guide (PDG) for details.
3. IVT_ID_N land is a no connect on die.

7.8.3.1 PCI Express* DC Specifications

The processor DC specifications for the PCI Express* are available in the *PCI Express Base Specification - Revision 3.0*. This document will provide only the processor exceptions to the *PCI Express Base Specification - Revision 3.0*.

7.8.3.2 DMI2/PCI Express* DC Specifications

The processor DC specifications for the DMI2/PCI Express* are available in the *PCI Express Base Specification 2.0 and 1.0*. This document will provide only the processor exceptions to the *PCI Express Base Specification 2.0 and 1.0*.

7.8.3.3 Intel QuickPath Interconnect DC Specifications

Intel QuickPath Interconnect specifications are defined at the processor lands. Please refer to the appropriate platform design guidelines for specific implementation details. In most cases, termination resistors are not required as these are integrated into the processor silicon.

7.8.3.4 Reset and Miscellaneous Signal DC Specifications

For a power-on Reset, RESET_N must stay active for at least 3.5 millisecond after V_{CC} and BCLK{0/1} have reached their proper specifications. RESET_N must not be kept asserted for more than 100 ms while PWRGOOD is asserted. RESET_N must be held asserted for at least 3.5 millisecond before it is deasserted again. RESET_N must be held asserted before PWRGOOD is asserted. This signal does not have on-die termination and must be terminated on the system board.



Figure 7-7. BCLK{0/1} Differential Clock Crosspoint Specification

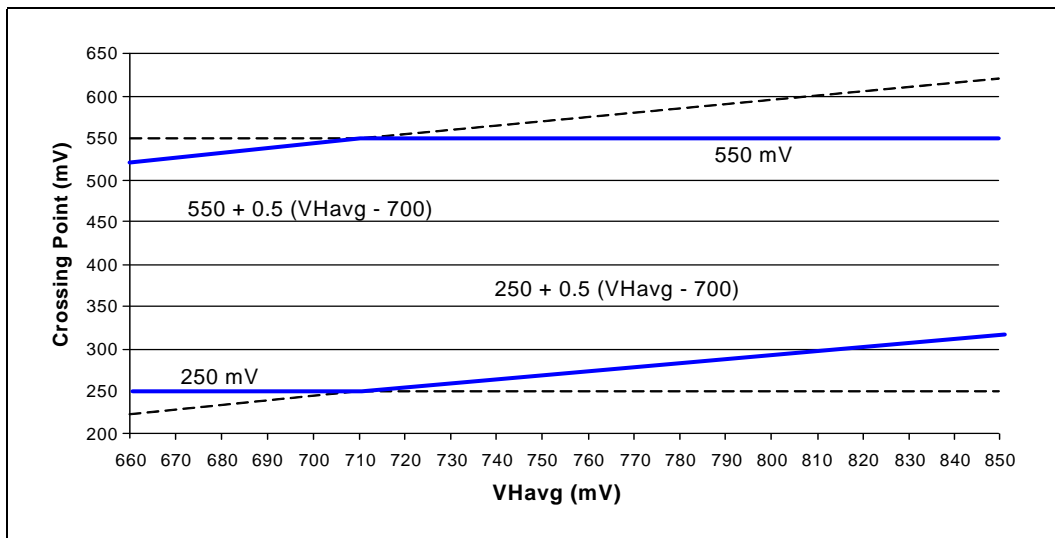


Figure 7-8. BCLK{0/1} Differential Clock Measurement Point for Ringback

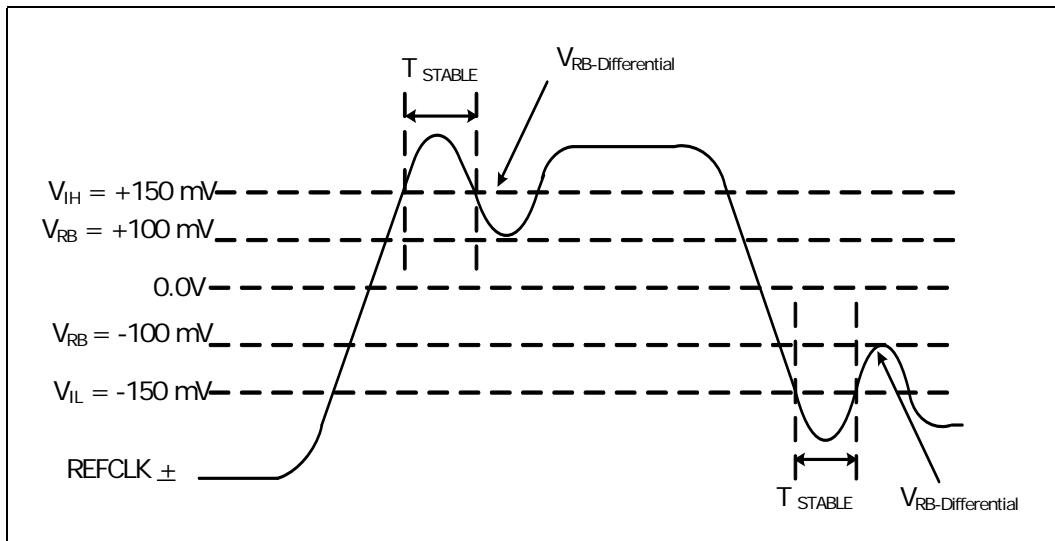


Figure 7-9. BCLK{0/1} Single Ended Clock Measurement Points for Absolute Cross Point and Swing

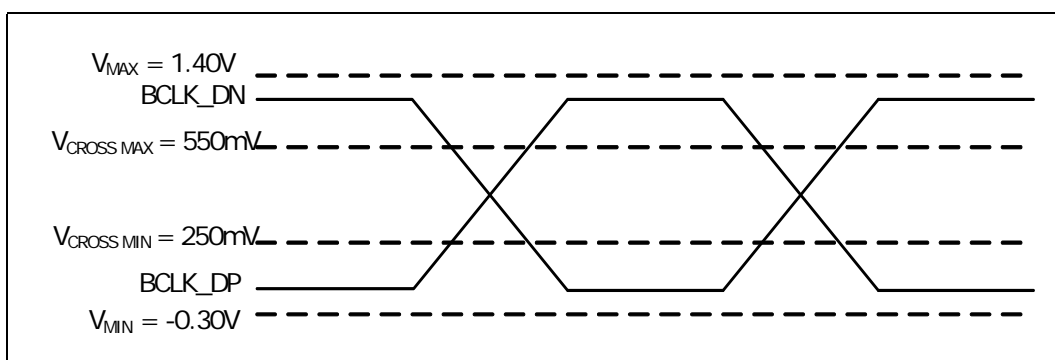
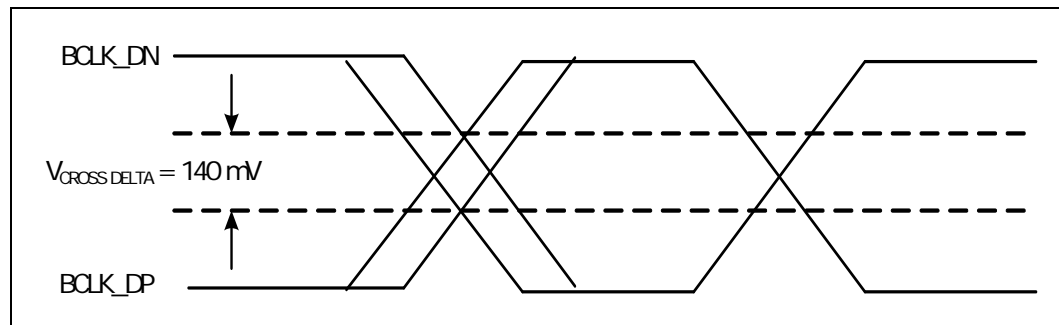


Figure 7-10. BCLK{0/1} Single Ended Clock Measurement Points for Delta Cross Point



7.9 Signal Quality

Data transfer requires the clean reception of data signals and clock signals. Ringing below receiver thresholds, non-monotonic signal edges, and excessive voltage swings will adversely affect system timings. Ringback and signal non-monotonicity cannot be tolerated since these phenomena may inadvertently advance receiver state machines. Excessive signal swings (overshoot and undershoot) are detrimental to silicon gate oxide integrity, and can cause device failure if absolute voltage limits are exceeded. Overshoot and undershoot can also cause timing degradation due to the build up of inter-symbol interference (ISI) effects.

For these reasons, it is crucial that the designer work towards a solution that provides acceptable signal quality across all systematic variations encountered in volume manufacturing.

This section documents signal quality metrics used to derive topology and routing guidelines through simulation. All specifications are specified at the processor die (pad measurements).

Specifications for signal quality are for measurements at the processor core only and are only observable through simulation. Therefore, proper simulation is the only way to verify proper timing and signal quality.

7.9.1 DDR3 Signal Quality Specifications

Various scenarios for the DDR3 Signals have been simulated to generate a set of layout guidelines which are available in the appropriate Platform Design Guide (PDG).

Overshoot (or undershoot) is the absolute value of the maximum voltage above or below V_{SS} . The overshoot/undershoot specifications limit transitions beyond specified maximum voltages or V_{SS} due to the fast signal edge rates. The processor can be damaged by single and/or repeated overshoot or undershoot events on any input, output, or I/O buffer if the charge is large enough (i.e., if the over/undershoot is great enough). Baseboard designs which meet signal integrity and timing requirements and which do not exceed the maximum overshoot or undershoot limits listed in [Table 7-24](#) will insure reliable IO performance for the lifetime of the processor.

7.9.2 I/O Signal Quality Specifications

Signal Quality specifications for PCIe* Signals are included as part of the PCIe* DC specifications. Various scenarios have been simulated to generate a set of layout guidelines which are available in the appropriate Platform Design Guide (PDG).



7.9.3 Intel QuickPath Interconnect Signal Quality Specifications

Signal Quality specifications for Differential Intel® QuickPath Interconnect Signals are included as part of the Intel QuickPath Interconnect signal quality specifications. Various scenarios have been simulated to generate a set of layout guidelines which are available in the appropriate Platform Design Guide (PDG).

7.9.4 Input Reference Clock Signal Quality Specifications

Overshoot/Undershoot and Ringback specifications for BCLK{0/1}_D[N/P] are found in Table 7-24. Overshoot/Undershoot and Ringback specifications for the DDR3 Reference Clocks are specified by the DIMM.

7.9.5 Overshoot/Undershoot Tolerance

Overshoot (or undershoot) is the absolute value of the maximum voltage above or below V_{SS} , see Figure 7-11. The overshoot/undershoot specifications limit transitions beyond V_{CCD} or V_{SS} due to the fast signal edge rates. The processor can be damaged by single and/or repeated overshoot or undershoot events on any input, output, or I/O buffer if the charge is large enough (that is, if the over/undershoot is great enough). Determining the impact of an overshoot/undershoot condition requires knowledge of the magnitude, the pulse direction, and the activity factor (AF). Permanent damage to the processor is the likely result of excessive overshoot/undershoot.

Baseboard designs which meet signal integrity and timing requirements and which do not exceed the maximum overshoot or undershoot limits listed in Table 7-24 will insure reliable IO performance for the lifetime of the processor.

Table 7-24. Processor I/O Overshoot/Undershoot Specifications

Signal Group	Minimum Undershoot	Maximum Overshoot	Overshoot Duration	Undershoot Duration	Notes
Intel QuickPath Interconnect	$-0.2 * V_{TT}$	$1.2 * V_{TT}$	39 ps	15 ps	1,2
DDR3	$-0.2 * V_{CCD}$	$1.2 * V_{CCD}$	$0.25 * T_{CH}$	$0.1 * T_{CH}$	1,2,3
System Reference Clock (BCLK{0/1})	-0.3V	1.15V	N/A	N/A	1,2
PWRGOOD Signal	-0.420V	$V_{TT} + 0.28$	N/A	N/A	4

Notes:

1. These specifications are measured at the processor pad.
2. Refer to Figure 7-11 for description of allowable Overshoot/Undershoot magnitude and duration.
3. TCH is the minimum high pulse width duration.
4. For PWRGOOD DC specifications see Table 7-22.

7.9.5.1 Overshoot/Undershoot Magnitude

Overshoot/Undershoot magnitude describes the maximum potential difference between a signal and its voltage reference level. For the processor, both overshoot and undershoot magnitude are referenced to V_{SS} . It is important to note that the overshoot and undershoot conditions are separate and their impact must be determined independently.

The pulse magnitude and duration, and activity factor must be used to determine if the overshoot/undershoot pulse is within specifications.



7.9.5.2 Overshoot/Undershoot Pulse Duration

Overshoot/undershoot pulse duration describes the total amount of time that an overshoot/undershoot event exceeds the overshoot/undershoot reference voltage. The total time could encompass several oscillations above the reference voltage. Multiple overshoot/undershoot pulses within a single overshoot/undershoot event may need to be measured to determine the total pulse duration.

Note: Oscillations below the reference voltage cannot be subtracted from the total overshoot/undershoot pulse duration.

7.9.5.3 Activity Factor

Activity factor (AF) describes the frequency of overshoot (or undershoot) occurrence relative to a clock. Since the highest frequency of assertion of any common clock signal is every other clock, an $AF = 0.1$ indicates that the specific overshoot (or undershoot) waveform occurs every other clock cycle.

The specification provided in the table shows the maximum pulse duration allowed for a given overshoot/undershoot magnitude at a specific activity factor. Each table entry is independent of all others, meaning that the pulse duration reflects the existence of overshoot/undershoot events of that magnitude ONLY. A platform with an overshoot/undershoot that just meets the pulse duration for a specific magnitude where the $AF < 0.1$, means that there can be no other overshoot/undershoot events, even of lesser magnitude (note that if $AF = 0.1$, then the event occurs at all times and no other events can occur).

7.9.5.4 Reading Overshoot/Undershoot Specification Tables

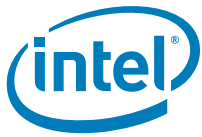
The overshoot/undershoot specification for the processor is not a simple single value. Instead, many factors are needed to determine the over/undershoot specification. In addition to the magnitude of the overshoot, the following parameters must also be known: the width of the overshoot and the activity factor (AF). To determine the allowed overshoot for a particular overshoot event, the following must be done:

1. Determine the signal group a particular signal falls into.
2. Determine the magnitude of the overshoot or the undershoot (relative to VSS).
3. Determine the activity factor (How often does this overshoot occur?).
4. Next, from the appropriate specification table, determine the maximum pulse duration (in nanoseconds) allowed.
5. Compare the specified maximum pulse duration to the signal being measured. If the pulse duration measured is less than the pulse duration shown in the table, then the signal meets the specifications.

Undershoot events must be analyzed separately from overshoot events as they are mutually exclusive.

7.9.5.5 Determining if a System Meets the Overshoot/Undershoot Specifications

The overshoot/undershoot specifications listed in the table specify the allowable overshoot/undershoot for a single overshoot/undershoot event. However most systems will have multiple overshoot and/or undershoot events that each have their own set of parameters (duration, AF and magnitude). While each overshoot on its own may meet



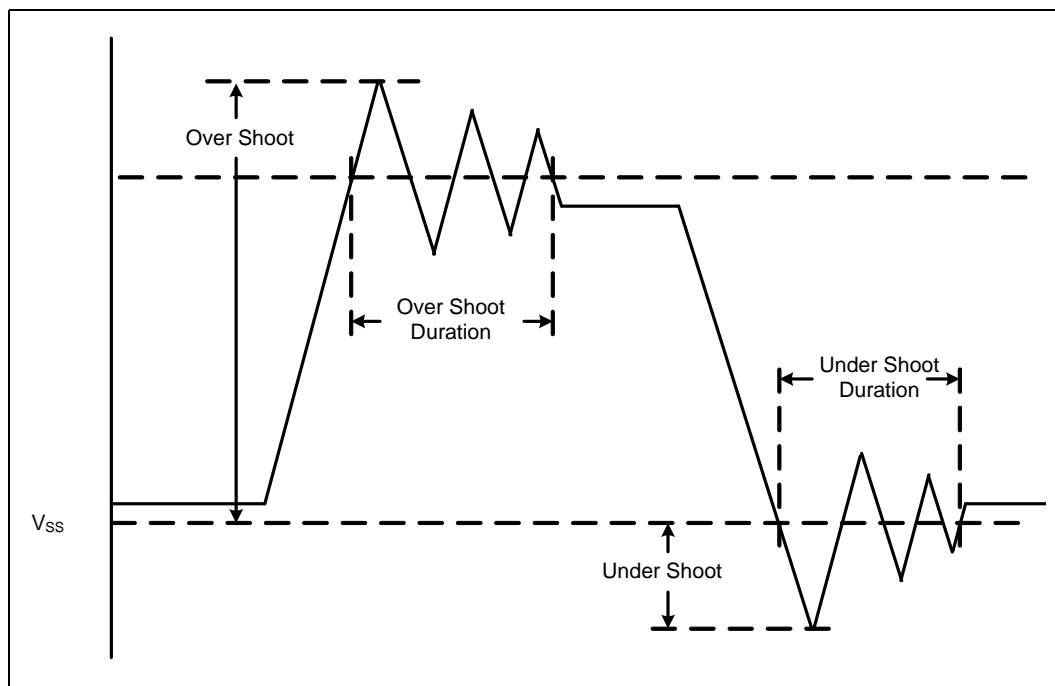
the overshoot specification, when you add the total impact of all overshoot events, the system may fail. A guideline to ensure a system passes the overshoot and undershoot specifications is shown below.

1. If only one overshoot/undershoot event magnitude occurs, ensure it meets the over/undershoot specifications in the following tables, OR
2. If multiple overshoots and/or multiple undershoots occur, measure the worst case pulse duration for each magnitude and compare the results against the AF = 0.1 specifications. If all of these worst case overshoot or undershoot events meet the specifications (measured time < specifications) in the table (where AF= 0.1), then the system passes.

Table 7-25. Processor Sideband Signal Group Overshoot/Undershoot Tolerance

Absolute Maximum Overshoot (V)	Absolute Maximum Undershoot (V)	Pulse Duration (ns) AF=0.1	Pulse Duration (ns) AF=0.01
1.3335 V	0.2835 V	3 ns	5 ns
1.2600 V	0.210 V	5 ns	5 ns

Figure 7-11. Maximum Acceptable Overshoot/Undershoot Waveform



§



8 Processor Land Listing

This chapter provides sorted land list in [Section 8.1](#) and [Section 8.2](#). [Table 8-1](#) is a listing of all processor lands ordered alphabetically by land name. [Table 8-2](#) is a listing of all processor lands ordered by land number.

8.1 Listing by Land Name

Table 8-1. Land Name (Sheet 1 of 49)

Land Name	Land No.	Buffer Type	Direction
BCLK0_DN	CM44	CMOS	I
BCLK0_DP	CN43	CMOS	I
BCLK1_DN	BA45	CMOS	I
BCLK1_DP	AW45	CMOS	I
BIST_ENABLE	AT48	CMOS	I
BMCINIT	AL47	CMOS	I
BPM_N[0]	AR43	ODCMOS	I/O
BPM_N[1]	AT44	ODCMOS	I/O
BPM_N[2]	AU43	ODCMOS	I/O
BPM_N[3]	AV44	ODCMOS	I/O
BPM_N[4]	BB44	ODCMOS	I/O
BPM_N[5]	AW43	ODCMOS	I/O
BPM_N[6]	BA43	ODCMOS	I/O
BPM_N[7]	AY44	ODCMOS	I/O
CAT_ERR_N	CC51	ODCMOS	I/O
CPU_ONLY_RESET	AN43	ODCMOS	I/O
DDR_RESET_C01_N	CB18	CMOS1.5v	O
DDR_RESET_C23_N	AE27	CMOS1.5v	O
DDR_SCL_C01	CY42	ODCMOS	I/O
DDR_SCL_C23	U43	ODCMOS	I/O
DDR_SDA_C01	CW41	ODCMOS	I/O
DDR_SDA_C23	R43	ODCMOS	I/O
DDR_VREFDQRX_C01	BY16	DC	I
DDR_VREFDQRX_C23	J1	DC	I
DDR_VREFDQTX_C01	CN41	DC	O
DDR_VREFDQTX_C23	P42	DC	O
DDR0_BA[0]	CM28	SSTL	O
DDR0_BA[1]	CN27	SSTL	O
DDR0_BA[2]	CM20	SSTL	O
DDR0_CAS_N	CL29	SSTL	O
DDR0_CKE[0]	CL19	SSTL	O
DDR0_CKE[1]	CM18	SSTL	O

Table 8-1. Land Name (Sheet 2 of 49)

Land Name	Land No.	Buffer Type	Direction
DDR0_CKE[2]	CH20	SSTL	O
DDR0_CKE[3]	CP18	SSTL	O
DDR0_CKE[4]	CF20	SSTL	O
DDR0_CKE[5]	CE19	SSTL	O
DDR0_CLK_DN[0]	CF24	SSTL	O
DDR0_CLK_DN[1]	CE23	SSTL	O
DDR0_CLK_DN[2]	CE21	SSTL	O
DDR0_CLK_DN[3]	CF22	SSTL	O
DDR0_CLK_DP[0]	CH24	SSTL	O
DDR0_CLK_DP[1]	CG23	SSTL	O
DDR0_CLK_DP[2]	CG21	SSTL	O
DDR0_CLK_DP[3]	CH22	SSTL	O
DDR0_CS_N[0]	CN25	SSTL	O
DDR0_CS_N[1]	CH26	SSTL	O
DDR0_CS_N[2]	CC23	SSTL	O
DDR0_CS_N[3]	CB28	SSTL	O
DDR0_CS_N[4]	CG27	SSTL	O
DDR0_CS_N[5]	CF26	SSTL	O
DDR0_CS_N[6]	CB26	SSTL	O
DDR0_CS_N[7]	CC25	SSTL	O
DDR0_CS_N[8]	CL27	SSTL	O
DDR0_CS_N[9]	CK28	SSTL	O
DDR0_DQ[00]	CC7	SSTL	I/O
DDR0_DQ[01]	CD8	SSTL	I/O
DDR0_DQ[02]	CK8	SSTL	I/O
DDR0_DQ[03]	CL9	SSTL	I/O
DDR0_DQ[04]	BY6	SSTL	I/O
DDR0_DQ[05]	CA7	SSTL	I/O
DDR0_DQ[06]	CJ7	SSTL	I/O
DDR0_DQ[07]	CL7	SSTL	I/O
DDR0_DQ[08]	CB2	SSTL	I/O
DDR0_DQ[09]	CB4	SSTL	I/O
DDR0_DQ[10]	CH4	SSTL	I/O



Table 8-1. Land Name (Sheet 3 of 49)

Land Name	Land No.	Buffer Type	Direction
DDR0_DQ[11]	CJ5	SSTL	I/O
DDR0_DQ[12]	CA1	SSTL	I/O
DDR0_DQ[13]	CA3	SSTL	I/O
DDR0_DQ[14]	CG3	SSTL	I/O
DDR0_DQ[15]	CG5	SSTL	I/O
DDR0_DQ[16]	CK12	SSTL	I/O
DDR0_DQ[17]	CM12	SSTL	I/O
DDR0_DQ[18]	CK16	SSTL	I/O
DDR0_DQ[19]	CM16	SSTL	I/O
DDR0_DQ[20]	CG13	SSTL	I/O
DDR0_DQ[21]	CL11	SSTL	I/O
DDR0_DQ[22]	CJ15	SSTL	I/O
DDR0_DQ[23]	CL15	SSTL	I/O
DDR0_DQ[24]	BY10	SSTL	I/O
DDR0_DQ[25]	BY12	SSTL	I/O
DDR0_DQ[26]	CB12	SSTL	I/O
DDR0_DQ[27]	CD12	SSTL	I/O
DDR0_DQ[28]	BW9	SSTL	I/O
DDR0_DQ[29]	CA9	SSTL	I/O
DDR0_DQ[30]	CH10	SSTL	I/O
DDR0_DQ[31]	CF10	SSTL	I/O
DDR0_DQ[32]	CE31	SSTL	I/O
DDR0_DQ[33]	CC31	SSTL	I/O
DDR0_DQ[34]	CE35	SSTL	I/O
DDR0_DQ[35]	CC35	SSTL	I/O
DDR0_DQ[36]	CD30	SSTL	I/O
DDR0_DQ[37]	CB30	SSTL	I/O
DDR0_DQ[38]	CD34	SSTL	I/O
DDR0_DQ[39]	CB34	SSTL	I/O
DDR0_DQ[40]	CL31	SSTL	I/O
DDR0_DQ[41]	CJ31	SSTL	I/O
DDR0_DQ[42]	CL35	SSTL	I/O
DDR0_DQ[43]	CJ35	SSTL	I/O
DDR0_DQ[44]	CK30	SSTL	I/O
DDR0_DQ[45]	CH30	SSTL	I/O
DDR0_DQ[46]	CK34	SSTL	I/O
DDR0_DQ[47]	CH34	SSTL	I/O
DDR0_DQ[48]	CB38	SSTL	I/O
DDR0_DQ[49]	CD38	SSTL	I/O
DDR0_DQ[50]	CE41	SSTL	I/O
DDR0_DQ[51]	CD42	SSTL	I/O
DDR0_DQ[52]	CC37	SSTL	I/O

Table 8-1. Land Name (Sheet 4 of 49)

Land Name	Land No.	Buffer Type	Direction
DDR0_DQ[53]	CE37	SSTL	I/O
DDR0_DQ[54]	CC41	SSTL	I/O
DDR0_DQ[55]	CB42	SSTL	I/O
DDR0_DQ[56]	CH38	SSTL	I/O
DDR0_DQ[57]	CK38	SSTL	I/O
DDR0_DQ[58]	CH42	SSTL	I/O
DDR0_DQ[59]	CK42	SSTL	I/O
DDR0_DQ[60]	CJ37	SSTL	I/O
DDR0_DQ[61]	CL37	SSTL	I/O
DDR0_DQ[62]	CJ41	SSTL	I/O
DDR0_DQ[63]	CL41	SSTL	I/O
DDR0_DQS_DN[00]	CG7	SSTL	I/O
DDR0_DQS_DN[01]	CE3	SSTL	I/O
DDR0_DQS_DN[02]	CH14	SSTL	I/O
DDR0_DQS_DN[03]	CD10	SSTL	I/O
DDR0_DQS_DN[04]	CE33	SSTL	I/O
DDR0_DQS_DN[05]	CL33	SSTL	I/O
DDR0_DQS_DN[06]	CB40	SSTL	I/O
DDR0_DQS_DN[07]	CH40	SSTL	I/O
DDR0_DQS_DN[08]	CE17	SSTL	I/O
DDR0_DQS_DN[09]	CF8	SSTL	I/O
DDR0_DQS_DN[10]	CD4	SSTL	I/O
DDR0_DQS_DN[11]	CL13	SSTL	I/O
DDR0_DQS_DN[12]	CC11	SSTL	I/O
DDR0_DQS_DN[13]	CB32	SSTL	I/O
DDR0_DQS_DN[14]	CH32	SSTL	I/O
DDR0_DQS_DN[15]	CE39	SSTL	I/O
DDR0_DQS_DN[16]	CL39	SSTL	I/O
DDR0_DQS_DN[17]	CF16	SSTL	I/O
DDR0_DQS_DP[00]	CH8	SSTL	I/O
DDR0_DQS_DP[01]	CF4	SSTL	I/O
DDR0_DQS_DP[02]	CK14	SSTL	I/O
DDR0_DQS_DP[03]	CE11	SSTL	I/O
DDR0_DQS_DP[04]	CC33	SSTL	I/O
DDR0_DQS_DP[05]	CJ33	SSTL	I/O
DDR0_DQS_DP[06]	CD40	SSTL	I/O
DDR0_DQS_DP[07]	CK40	SSTL	I/O
DDR0_DQS_DP[08]	CC17	SSTL	I/O
DDR0_DQS_DP[09]	CE7	SSTL	I/O
DDR0_DQS_DP[10]	CC5	SSTL	I/O
DDR0_DQS_DP[11]	CJ13	SSTL	I/O
DDR0_DQS_DP[12]	CB10	SSTL	I/O



Table 8-1. Land Name (Sheet 5 of 49)

Land Name	Land No.	Buffer Type	Direction
DDR0_DQS_DP[13]	CD32	SSTL	I/O
DDR0_DQS_DP[14]	CK32	SSTL	I/O
DDR0_DQS_DP[15]	CC39	SSTL	I/O
DDR0_DQS_DP[16]	CJ39	SSTL	I/O
DDR0_DQS_DP[17]	CD16	SSTL	I/O
DDR0_ECC[0]	CE15	SSTL	I/O
DDR0_ECC[1]	CC15	SSTL	I/O
DDR0_ECC[2]	CH18	SSTL	I/O
DDR0_ECC[3]	CF18	SSTL	I/O
DDR0_ECC[4]	CB14	SSTL	I/O
DDR0_ECC[5]	CD14	SSTL	I/O
DDR0_ECC[6]	CG17	SSTL	I/O
DDR0_ECC[7]	CK18	SSTL	I/O
DDR0_MA_PAR	CM26	SSTL	O
DDR0_MA[00]	CL25	SSTL	O
DDR0_MA[01]	CR25	SSTL	O
DDR0_MA[02]	CG25	SSTL	O
DDR0_MA[03]	CK24	SSTL	O
DDR0_MA[04]	CM24	SSTL	O
DDR0_MA[05]	CL23	SSTL	O
DDR0_MA[06]	CN23	SSTL	O
DDR0_MA[07]	CM22	SSTL	O
DDR0_MA[08]	CK22	SSTL	O
DDR0_MA[09]	CN21	SSTL	O
DDR0_MA[10]	CK26	SSTL	O
DDR0_MA[11]	CL21	SSTL	O
DDR0_MA[12]	CK20	SSTL	O
DDR0_MA[13]	CG29	SSTL	O
DDR0_MA[14]	CG19	SSTL	O
DDR0_MA[15]	CN19	SSTL	O
DDR0_ODT[0]	CE25	SSTL	O
DDR0_ODT[1]	CE27	SSTL	O
DDR0_ODT[2]	CH28	SSTL	O
DDR0_ODT[3]	CF28	SSTL	O
DDR0_ODT[4]	CB24	SSTL	O
DDR0_ODT[5]	CC27	SSTL	O
DDR0_PAR_ERR_N	CC21	SSTL	I
DDR0_RAS_N	CE29	SSTL	O
DDR0_WE_N	CN29	SSTL	O
DDR01_RCOMP[0]	CA17	Analog	I
DDR01_RCOMP[1]	CC19	Analog	I
DDR01_RCOMP[2]	CB20	Analog	I

Table 8-1. Land Name (Sheet 6 of 49)

Land Name	Land No.	Buffer Type	Direction
DDR1_BA[0]	DB26	SSTL	O
DDR1_BA[1]	DC25	SSTL	O
DDR1_BA[2]	DF18	SSTL	O
DDR1_CAS_N	CY30	SSTL	O
DDR1_CKE[0]	CT20	SSTL	O
DDR1_CKE[1]	CU19	SSTL	O
DDR1_CKE[2]	CY18	SSTL	O
DDR1_CKE[3]	DA17	SSTL	O
DDR1_CKE[4]	CR19	SSTL	O
DDR1_CKE[5]	CT18	SSTL	O
DDR1_CLK_DN[0]	CV20	SSTL	O
DDR1_CLK_DN[1]	CV22	SSTL	O
DDR1_CLK_DN[2]	CY24	SSTL	O
DDR1_CLK_DN[3]	DA21	SSTL	O
DDR1_CLK_DP[0]	CY20	SSTL	O
DDR1_CLK_DP[1]	CY22	SSTL	O
DDR1_CLK_DP[2]	CV24	SSTL	O
DDR1_CLK_DP[3]	DC21	SSTL	O
DDR1_CS_N[0]	DB24	SSTL	O
DDR1_CS_N[1]	CU23	SSTL	O
DDR1_CS_N[2]	CR23	SSTL	O
DDR1_CS_N[3]	CR27	SSTL	O
DDR1_CS_N[4]	CU25	SSTL	O
DDR1_CS_N[5]	CT24	SSTL	O
DDR1_CS_N[6]	DA29	SSTL	O
DDR1_CS_N[7]	CT26	SSTL	O
DDR1_CS_N[8]	CR21	SSTL	O
DDR1_CS_N[9]	DA27	SSTL	O
DDR1_DQ[00]	CP4	SSTL	I/O
DDR1_DQ[01]	CP2	SSTL	I/O
DDR1_DQ[02]	CV4	SSTL	I/O
DDR1_DQ[03]	CY4	SSTL	I/O
DDR1_DQ[04]	CM4	SSTL	I/O
DDR1_DQ[05]	CL3	SSTL	I/O
DDR1_DQ[06]	CV2	SSTL	I/O
DDR1_DQ[07]	CW3	SSTL	I/O
DDR1_DQ[08]	DA7	SSTL	I/O
DDR1_DQ[09]	DC7	SSTL	I/O
DDR1_DQ[10]	DC11	SSTL	I/O
DDR1_DQ[11]	DE11	SSTL	I/O
DDR1_DQ[12]	CY6	SSTL	I/O
DDR1_DQ[13]	DB6	SSTL	I/O



Table 8-1. Land Name (Sheet 7 of 49)

Land Name	Land No.	Buffer Type	Direction
DDR1_DQ[14]	DB10	SSTL	I/O
DDR1_DQ[15]	DF10	SSTL	I/O
DDR1_DQ[16]	CR7	SSTL	I/O
DDR1_DQ[17]	CU7	SSTL	I/O
DDR1_DQ[18]	CT10	SSTL	I/O
DDR1_DQ[19]	CP10	SSTL	I/O
DDR1_DQ[20]	CP6	SSTL	I/O
DDR1_DQ[21]	CT6	SSTL	I/O
DDR1_DQ[22]	CW9	SSTL	I/O
DDR1_DQ[23]	CV10	SSTL	I/O
DDR1_DQ[24]	CR13	SSTL	I/O
DDR1_DQ[25]	CU13	SSTL	I/O
DDR1_DQ[26]	CR17	SSTL	I/O
DDR1_DQ[27]	CU17	SSTL	I/O
DDR1_DQ[28]	CT12	SSTL	I/O
DDR1_DQ[29]	CV12	SSTL	I/O
DDR1_DQ[30]	CT16	SSTL	I/O
DDR1_DQ[31]	CV16	SSTL	I/O
DDR1_DQ[32]	CT30	SSTL	I/O
DDR1_DQ[33]	CP30	SSTL	I/O
DDR1_DQ[34]	CT34	SSTL	I/O
DDR1_DQ[35]	CP34	SSTL	I/O
DDR1_DQ[36]	CU29	SSTL	I/O
DDR1_DQ[37]	CR29	SSTL	I/O
DDR1_DQ[38]	CU33	SSTL	I/O
DDR1_DQ[39]	CR33	SSTL	I/O
DDR1_DQ[40]	DA33	SSTL	I/O
DDR1_DQ[41]	DD32	SSTL	I/O
DDR1_DQ[42]	DC35	SSTL	I/O
DDR1_DQ[43]	DA35	SSTL	I/O
DDR1_DQ[44]	DA31	SSTL	I/O
DDR1_DQ[45]	CY32	SSTL	I/O
DDR1_DQ[46]	DF34	SSTL	I/O
DDR1_DQ[47]	DE35	SSTL	I/O
DDR1_DQ[48]	CR37	SSTL	I/O
DDR1_DQ[49]	CU37	SSTL	I/O
DDR1_DQ[50]	CR41	SSTL	I/O
DDR1_DQ[51]	CU41	SSTL	I/O
DDR1_DQ[52]	CT36	SSTL	I/O
DDR1_DQ[53]	CV36	SSTL	I/O
DDR1_DQ[54]	CT40	SSTL	I/O
DDR1_DQ[55]	CV40	SSTL	I/O

Table 8-1. Land Name (Sheet 8 of 49)

Land Name	Land No.	Buffer Type	Direction
DDR1_DQ[56]	DE37	SSTL	I/O
DDR1_DQ[57]	DF38	SSTL	I/O
DDR1_DQ[58]	DD40	SSTL	I/O
DDR1_DQ[59]	DB40	SSTL	I/O
DDR1_DQ[60]	DA37	SSTL	I/O
DDR1_DQ[61]	DC37	SSTL	I/O
DDR1_DQ[62]	DA39	SSTL	I/O
DDR1_DQ[63]	DF40	SSTL	I/O
DDR1_DQS_DN[00]	CT4	SSTL	I/O
DDR1_DQS_DN[01]	DC9	SSTL	I/O
DDR1_DQS_DN[02]	CV8	SSTL	I/O
DDR1_DQS_DN[03]	CR15	SSTL	I/O
DDR1_DQS_DN[04]	CT32	SSTL	I/O
DDR1_DQS_DN[05]	CY34	SSTL	I/O
DDR1_DQS_DN[06]	CR39	SSTL	I/O
DDR1_DQS_DN[07]	DE39	SSTL	I/O
DDR1_DQS_DN[08]	DE15	SSTL	I/O
DDR1_DQS_DN[09]	CR1	SSTL	I/O
DDR1_DQS_DN[10]	DB8	SSTL	I/O
DDR1_DQS_DN[11]	CT8	SSTL	I/O
DDR1_DQS_DN[12]	CP14	SSTL	I/O
DDR1_DQS_DN[13]	CR31	SSTL	I/O
DDR1_DQS_DN[14]	DE33	SSTL	I/O
DDR1_DQS_DN[15]	CT38	SSTL	I/O
DDR1_DQS_DN[16]	CY38	SSTL	I/O
DDR1_DQS_DN[17]	DB14	SSTL	I/O
DDR1_DQS_DP[00]	CR3	SSTL	I/O
DDR1_DQS_DP[01]	DE9	SSTL	I/O
DDR1_DQS_DP[02]	CU9	SSTL	I/O
DDR1_DQS_DP[03]	CU15	SSTL	I/O
DDR1_DQS_DP[04]	CP32	SSTL	I/O
DDR1_DQS_DP[05]	DB34	SSTL	I/O
DDR1_DQS_DP[06]	CU39	SSTL	I/O
DDR1_DQS_DP[07]	DC39	SSTL	I/O
DDR1_DQS_DP[08]	DC15	SSTL	I/O
DDR1_DQS_DP[09]	CT2	SSTL	I/O
DDR1_DQS_DP[10]	DD8	SSTL	I/O
DDR1_DQS_DP[11]	CP8	SSTL	I/O
DDR1_DQS_DP[12]	CT14	SSTL	I/O
DDR1_DQS_DP[13]	CU31	SSTL	I/O
DDR1_DQS_DP[14]	DC33	SSTL	I/O
DDR1_DQS_DP[15]	CP38	SSTL	I/O



Table 8-1. Land Name (Sheet 9 of 49)

Land Name	Land No.	Buffer Type	Direction
DDR1_DQS_DP[16]	DB38	SSTL	I/O
DDR1_DQS_DP[17]	CY14	SSTL	I/O
DDR1_ECC[0]	DE13	SSTL	I/O
DDR1_ECC[1]	DF14	SSTL	I/O
DDR1_ECC[2]	DD16	SSTL	I/O
DDR1_ECC[3]	DB16	SSTL	I/O
DDR1_ECC[4]	DA13	SSTL	I/O
DDR1_ECC[5]	DC13	SSTL	I/O
DDR1_ECC[6]	DA15	SSTL	I/O
DDR1_ECC[7]	DF16	SSTL	I/O
DDR1_MA_PAR	DE25	SSTL	O
DDR1_MA[00]	DC23	SSTL	O
DDR1_MA[01]	DE23	SSTL	O
DDR1_MA[02]	DF24	SSTL	O
DDR1_MA[03]	DA23	SSTL	O
DDR1_MA[04]	DB22	SSTL	O
DDR1_MA[05]	DF22	SSTL	O
DDR1_MA[06]	DE21	SSTL	O
DDR1_MA[07]	DF20	SSTL	O
DDR1_MA[08]	DB20	SSTL	O
DDR1_MA[09]	DA19	SSTL	O
DDR1_MA[10]	DF26	SSTL	O
DDR1_MA[11]	DE19	SSTL	O
DDR1_MA[12]	DC19	SSTL	O
DDR1_MA[13]	DB30	SSTL	O
DDR1_MA[14]	DB18	SSTL	O
DDR1_MA[15]	DC17	SSTL	O
DDR1_ODT[0]	CT22	SSTL	O
DDR1_ODT[1]	DA25	SSTL	O
DDR1_ODT[2]	CY26	SSTL	O
DDR1_ODT[3]	CV26	SSTL	O
DDR1_ODT[4]	CU27	SSTL	O
DDR1_ODT[5]	CY28	SSTL	O
DDR1_PAR_ERR_N	CU21	SSTL	I
DDR1_RAS_N	DB28	SSTL	O
DDR1_WE_N	CV28	SSTL	O
DDR2_BA[0]	R17	SSTL	O
DDR2_BA[1]	L17	SSTL	O
DDR2_BA[2]	P24	SSTL	O
DDR2_CAS_N	T16	SSTL	O
DDR2_CKE[0]	AA25	SSTL	O
DDR2_CKE[1]	T26	SSTL	O

Table 8-1. Land Name (Sheet 10 of 49)

Land Name	Land No.	Buffer Type	Direction
DDR2_CKE[2]	U27	SSTL	O
DDR2_CKE[3]	AD24	SSTL	O
DDR2_CKE[4]	AE25	SSTL	O
DDR2_CKE[5]	AE23	SSTL	O
DDR2_CLK_DN[0]	Y24	SSTL	O
DDR2_CLK_DN[1]	Y22	SSTL	O
DDR2_CLK_DN[2]	W21	SSTL	O
DDR2_CLK_DN[3]	W23	SSTL	O
DDR2_CLK_DP[0]	AB24	SSTL	O
DDR2_CLK_DP[1]	AB22	SSTL	O
DDR2_CLK_DP[2]	AA21	SSTL	O
DDR2_CLK_DP[3]	AA23	SSTL	O
DDR2_CS_N[0]	AB20	SSTL	O
DDR2_CS_N[1]	AE19	SSTL	O
DDR2_CS_N[2]	AD16	SSTL	O
DDR2_CS_N[3]	AA15	SSTL	O
DDR2_CS_N[4]	AA19	SSTL	O
DDR2_CS_N[5]	P18	SSTL	O
DDR2_CS_N[6]	AB16	SSTL	O
DDR2_CS_N[7]	Y16	SSTL	O
DDR2_CS_N[8]	W17	SSTL	O
DDR2_CS_N[9]	AA17	SSTL	O
DDR2_DQ[00]	T40	SSTL	I/O
DDR2_DQ[01]	V40	SSTL	I/O
DDR2_DQ[02]	P36	SSTL	I/O
DDR2_DQ[03]	T36	SSTL	I/O
DDR2_DQ[04]	R41	SSTL	I/O
DDR2_DQ[05]	U41	SSTL	I/O
DDR2_DQ[06]	R37	SSTL	I/O
DDR2_DQ[07]	U37	SSTL	I/O
DDR2_DQ[08]	AE41	SSTL	I/O
DDR2_DQ[09]	AD40	SSTL	I/O
DDR2_DQ[10]	AA37	SSTL	I/O
DDR2_DQ[11]	AC37	SSTL	I/O
DDR2_DQ[12]	AC41	SSTL	I/O
DDR2_DQ[13]	AA41	SSTL	I/O
DDR2_DQ[14]	AF38	SSTL	I/O
DDR2_DQ[15]	AE37	SSTL	I/O
DDR2_DQ[16]	U33	SSTL	I/O
DDR2_DQ[17]	R33	SSTL	I/O
DDR2_DQ[18]	W29	SSTL	I/O
DDR2_DQ[19]	U29	SSTL	I/O



Table 8-1. Land Name (Sheet 11 of 49)

Land Name	Land No.	Buffer Type	Direction
DDR2_DQ[20]	T34	SSTL	I/O
DDR2_DQ[21]	P34	SSTL	I/O
DDR2_DQ[22]	V30	SSTL	I/O
DDR2_DQ[23]	T30	SSTL	I/O
DDR2_DQ[24]	AC35	SSTL	I/O
DDR2_DQ[25]	AE35	SSTL	I/O
DDR2_DQ[26]	AE33	SSTL	I/O
DDR2_DQ[27]	AF32	SSTL	I/O
DDR2_DQ[28]	AA35	SSTL	I/O
DDR2_DQ[29]	W35	SSTL	I/O
DDR2_DQ[30]	AB32	SSTL	I/O
DDR2_DQ[31]	AD32	SSTL	I/O
DDR2_DQ[32]	AC13	SSTL	I/O
DDR2_DQ[33]	AE13	SSTL	I/O
DDR2_DQ[34]	AG11	SSTL	I/O
DDR2_DQ[35]	AF10	SSTL	I/O
DDR2_DQ[36]	AD14	SSTL	I/O
DDR2_DQ[37]	AA13	SSTL	I/O
DDR2_DQ[38]	AB10	SSTL	I/O
DDR2_DQ[39]	AD10	SSTL	I/O
DDR2_DQ[40]	V6	SSTL	I/O
DDR2_DQ[41]	Y6	SSTL	I/O
DDR2_DQ[42]	AF8	SSTL	I/O
DDR2_DQ[43]	AG7	SSTL	I/O
DDR2_DQ[44]	U7	SSTL	I/O
DDR2_DQ[45]	W7	SSTL	I/O
DDR2_DQ[46]	AD8	SSTL	I/O
DDR2_DQ[47]	AE7	SSTL	I/O
DDR2_DQ[48]	R13	SSTL	I/O
DDR2_DQ[49]	U13	SSTL	I/O
DDR2_DQ[50]	T10	SSTL	I/O
DDR2_DQ[51]	V10	SSTL	I/O
DDR2_DQ[52]	T14	SSTL	I/O
DDR2_DQ[53]	V14	SSTL	I/O
DDR2_DQ[54]	R9	SSTL	I/O
DDR2_DQ[55]	U9	SSTL	I/O
DDR2_DQ[56]	W3	SSTL	I/O
DDR2_DQ[57]	Y4	SSTL	I/O
DDR2_DQ[58]	AF4	SSTL	I/O
DDR2_DQ[59]	AE5	SSTL	I/O
DDR2_DQ[60]	U3	SSTL	I/O
DDR2_DQ[61]	V4	SSTL	I/O

Table 8-1. Land Name (Sheet 12 of 49)

Land Name	Land No.	Buffer Type	Direction
DDR2_DQ[62]	AF2	SSTL	I/O
DDR2_DQ[63]	AE3	SSTL	I/O
DDR2_DQS_DN[00]	T38	SSTL	I/O
DDR2_DQS_DN[01]	AD38	SSTL	I/O
DDR2_DQS_DN[02]	W31	SSTL	I/O
DDR2_DQS_DN[03]	AA33	SSTL	I/O
DDR2_DQS_DN[04]	AC11	SSTL	I/O
DDR2_DQS_DN[05]	AB8	SSTL	I/O
DDR2_DQS_DN[06]	U11	SSTL	I/O
DDR2_DQS_DN[07]	AC3	SSTL	I/O
DDR2_DQS_DN[08]	AB28	SSTL	I/O
DDR2_DQS_DN[09]	W39	SSTL	I/O
DDR2_DQS_DN[10]	AC39	SSTL	I/O
DDR2_DQS_DN[11]	T32	SSTL	I/O
DDR2_DQS_DN[12]	AB34	SSTL	I/O
DDR2_DQS_DN[13]	AD12	SSTL	I/O
DDR2_DQS_DN[14]	AA7	SSTL	I/O
DDR2_DQS_DN[15]	V12	SSTL	I/O
DDR2_DQS_DN[16]	AD4	SSTL	I/O
DDR2_DQS_DN[17]	AD28	SSTL	I/O
DDR2_DQS_DP[00]	V38	SSTL	I/O
DDR2_DQS_DP[01]	AB38	SSTL	I/O
DDR2_DQS_DP[02]	U31	SSTL	I/O
DDR2_DQS_DP[03]	AC33	SSTL	I/O
DDR2_DQS_DP[04]	AE11	SSTL	I/O
DDR2_DQS_DP[05]	AC7	SSTL	I/O
DDR2_DQS_DP[06]	W11	SSTL	I/O
DDR2_DQS_DP[07]	AB4	SSTL	I/O
DDR2_DQS_DP[08]	AC27	SSTL	I/O
DDR2_DQS_DP[09]	U39	SSTL	I/O
DDR2_DQS_DP[10]	AB40	SSTL	I/O
DDR2_DQS_DP[11]	V32	SSTL	I/O
DDR2_DQS_DP[12]	Y34	SSTL	I/O
DDR2_DQS_DP[13]	AB12	SSTL	I/O
DDR2_DQS_DP[14]	Y8	SSTL	I/O
DDR2_DQS_DP[15]	T12	SSTL	I/O
DDR2_DQS_DP[16]	AC5	SSTL	I/O
DDR2_DQS_DP[17]	AC29	SSTL	I/O
DDR2_ECC[0]	AF30	SSTL	I/O
DDR2_ECC[1]	AF28	SSTL	I/O
DDR2_ECC[2]	Y26	SSTL	I/O
DDR2_ECC[3]	AB26	SSTL	I/O



Table 8-1. Land Name (Sheet 13 of 49)

Land Name	Land No.	Buffer Type	Direction
DDR2_ECC[4]	AB30	SSTL	I/O
DDR2_ECC[5]	AD30	SSTL	I/O
DDR2_ECC[6]	W27	SSTL	I/O
DDR2_ECC[7]	AA27	SSTL	I/O
DDR2_MA_PAR	M18	SSTL	O
DDR2_MA[00]	AB18	SSTL	O
DDR2_MA[01]	R19	SSTL	O
DDR2_MA[02]	U19	SSTL	O
DDR2_MA[03]	T20	SSTL	O
DDR2_MA[04]	P20	SSTL	O
DDR2_MA[05]	U21	SSTL	O
DDR2_MA[06]	R21	SSTL	O
DDR2_MA[07]	P22	SSTL	O
DDR2_MA[08]	T22	SSTL	O
DDR2_MA[09]	R23	SSTL	O
DDR2_MA[10]	T18	SSTL	O
DDR2_MA[11]	U23	SSTL	O
DDR2_MA[12]	T24	SSTL	O
DDR2_MA[13]	R15	SSTL	O
DDR2_MA[14]	W25	SSTL	O
DDR2_MA[15]	U25	SSTL	O
DDR2_ODT[0]	Y20	SSTL	O
DDR2_ODT[1]	W19	SSTL	O
DDR2_ODT[2]	AD18	SSTL	O
DDR2_ODT[3]	Y18	SSTL	O
DDR2_ODT[4]	AD22	SSTL	O
DDR2_ODT[5]	AE21	SSTL	O
DDR2_PAR_ERR_N	AD20	SSTL	I
DDR2_RAS_N	U17	SSTL	O
DDR2_WE_N	P16	SSTL	O
DDR23_RCOMP[0]	U15	Analog	I
DDR23_RCOMP[1]	AC15	Analog	I
DDR23_RCOMP[2]	Y14	Analog	I
DDR3_BA[0]	A17	SSTL	O
DDR3_BA[1]	E19	SSTL	O
DDR3_BA[2]	B24	SSTL	O
DDR3_CAS_N	B14	SSTL	O
DDR3_CKE[0]	K24	SSTL	O
DDR3_CKE[1]	M24	SSTL	O
DDR3_CKE[2]	J25	SSTL	O
DDR3_CKE[3]	N25	SSTL	O
DDR3_CKE[4]	R25	SSTL	O

Table 8-1. Land Name (Sheet 14 of 49)

Land Name	Land No.	Buffer Type	Direction
DDR3_CKE[5]	R27	SSTL	O
DDR3_CLK_DN[0]	J23	SSTL	O
DDR3_CLK_DN[1]	J21	SSTL	O
DDR3_CLK_DN[2]	M20	SSTL	O
DDR3_CLK_DN[3]	K22	SSTL	O
DDR3_CLK_DP[0]	L23	SSTL	O
DDR3_CLK_DP[1]	L21	SSTL	O
DDR3_CLK_DP[2]	K20	SSTL	O
DDR3_CLK_DP[3]	M22	SSTL	O
DDR3_CS_N[0]	G19	SSTL	O
DDR3_CS_N[1]	J19	SSTL	O
DDR3_CS_N[2]	F14	SSTL	O
DDR3_CS_N[3]	G15	SSTL	O
DDR3_CS_N[4]	K18	SSTL	O
DDR3_CS_N[5]	G17	SSTL	O
DDR3_CS_N[6]	F16	SSTL	O
DDR3_CS_N[7]	E15	SSTL	O
DDR3_CS_N[8]	D16	SSTL	O
DDR3_CS_N[9]	K16	SSTL	O
DDR3_DQ[00]	B40	SSTL	I/O
DDR3_DQ[01]	A39	SSTL	I/O
DDR3_DQ[02]	C37	SSTL	I/O
DDR3_DQ[03]	E37	SSTL	I/O
DDR3_DQ[04]	F40	SSTL	I/O
DDR3_DQ[05]	D40	SSTL	I/O
DDR3_DQ[06]	F38	SSTL	I/O
DDR3_DQ[07]	A37	SSTL	I/O
DDR3_DQ[08]	N39	SSTL	I/O
DDR3_DQ[09]	L39	SSTL	I/O
DDR3_DQ[10]	L35	SSTL	I/O
DDR3_DQ[11]	J35	SSTL	I/O
DDR3_DQ[12]	M40	SSTL	I/O
DDR3_DQ[13]	K40	SSTL	I/O
DDR3_DQ[14]	K36	SSTL	I/O
DDR3_DQ[15]	H36	SSTL	I/O
DDR3_DQ[16]	A35	SSTL	I/O
DDR3_DQ[17]	F34	SSTL	I/O
DDR3_DQ[18]	D32	SSTL	I/O
DDR3_DQ[19]	F32	SSTL	I/O
DDR3_DQ[20]	E35	SSTL	I/O
DDR3_DQ[21]	C35	SSTL	I/O
DDR3_DQ[22]	A33	SSTL	I/O



Table 8-1. Land Name (Sheet 15 of 49)

Land Name	Land No.	Buffer Type	Direction
DDR3_DQ[23]	B32	SSTL	I/O
DDR3_DQ[24]	M32	SSTL	I/O
DDR3_DQ[25]	L31	SSTL	I/O
DDR3_DQ[26]	M28	SSTL	I/O
DDR3_DQ[27]	L27	SSTL	I/O
DDR3_DQ[28]	L33	SSTL	I/O
DDR3_DQ[29]	K32	SSTL	I/O
DDR3_DQ[30]	N27	SSTL	I/O
DDR3_DQ[31]	M26	SSTL	I/O
DDR3_DQ[32]	D12	SSTL	I/O
DDR3_DQ[33]	A11	SSTL	I/O
DDR3_DQ[34]	C9	SSTL	I/O
DDR3_DQ[35]	E9	SSTL	I/O
DDR3_DQ[36]	F12	SSTL	I/O
DDR3_DQ[37]	B12	SSTL	I/O
DDR3_DQ[38]	F10	SSTL	I/O
DDR3_DQ[39]	A9	SSTL	I/O
DDR3_DQ[40]	J13	SSTL	I/O
DDR3_DQ[41]	L13	SSTL	I/O
DDR3_DQ[42]	J9	SSTL	I/O
DDR3_DQ[43]	L9	SSTL	I/O
DDR3_DQ[44]	K14	SSTL	I/O
DDR3_DQ[45]	M14	SSTL	I/O
DDR3_DQ[46]	K10	SSTL	I/O
DDR3_DQ[47]	M10	SSTL	I/O
DDR3_DQ[48]	E7	SSTL	I/O
DDR3_DQ[49]	F6	SSTL	I/O
DDR3_DQ[50]	N7	SSTL	I/O
DDR3_DQ[51]	P6	SSTL	I/O
DDR3_DQ[52]	C7	SSTL	I/O
DDR3_DQ[53]	D6	SSTL	I/O
DDR3_DQ[54]	L7	SSTL	I/O
DDR3_DQ[55]	M6	SSTL	I/O
DDR3_DQ[56]	G3	SSTL	I/O
DDR3_DQ[57]	H2	SSTL	I/O
DDR3_DQ[58]	N3	SSTL	I/O
DDR3_DQ[59]	P4	SSTL	I/O
DDR3_DQ[60]	F4	SSTL	I/O
DDR3_DQ[61]	H4	SSTL	I/O
DDR3_DQ[62]	L1	SSTL	I/O
DDR3_DQ[63]	M2	SSTL	I/O
DDR3_DQS_DN[00]	B38	SSTL	I/O

Table 8-1. Land Name (Sheet 16 of 49)

Land Name	Land No.	Buffer Type	Direction
DDR3_DQS_DN[01]	L37	SSTL	I/O
DDR3_DQS_DN[02]	G33	SSTL	I/O
DDR3_DQS_DN[03]	P28	SSTL	I/O
DDR3_DQS_DN[04]	B10	SSTL	I/O
DDR3_DQS_DN[05]	L11	SSTL	I/O
DDR3_DQS_DN[06]	J7	SSTL	I/O
DDR3_DQS_DN[07]	L3	SSTL	I/O
DDR3_DQS_DN[08]	G27	SSTL	I/O
DDR3_DQS_DN[09]	G39	SSTL	I/O
DDR3_DQS_DN[10]	K38	SSTL	I/O
DDR3_DQS_DN[11]	B34	SSTL	I/O
DDR3_DQS_DN[12]	M30	SSTL	I/O
DDR3_DQS_DN[13]	G11	SSTL	I/O
DDR3_DQS_DN[14]	M12	SSTL	I/O
DDR3_DQS_DN[15]	H6	SSTL	I/O
DDR3_DQS_DN[16]	K4	SSTL	I/O
DDR3_DQS_DN[17]	H28	SSTL	I/O
DDR3_DQS_DP[00]	D38	SSTL	I/O
DDR3_DQS_DP[01]	J37	SSTL	I/O
DDR3_DQS_DP[02]	E33	SSTL	I/O
DDR3_DQS_DP[03]	N29	SSTL	I/O
DDR3_DQS_DP[04]	D10	SSTL	I/O
DDR3_DQS_DP[05]	N11	SSTL	I/O
DDR3_DQS_DP[06]	K6	SSTL	I/O
DDR3_DQS_DP[07]	M4	SSTL	I/O
DDR3_DQS_DP[08]	E27	SSTL	I/O
DDR3_DQS_DP[09]	E39	SSTL	I/O
DDR3_DQS_DP[10]	M38	SSTL	I/O
DDR3_DQS_DP[11]	D34	SSTL	I/O
DDR3_DQS_DP[12]	N31	SSTL	I/O
DDR3_DQS_DP[13]	E11	SSTL	I/O
DDR3_DQS_DP[14]	K12	SSTL	I/O
DDR3_DQS_DP[15]	G7	SSTL	I/O
DDR3_DQS_DP[16]	J3	SSTL	I/O
DDR3_DQS_DP[17]	F28	SSTL	I/O
DDR3_ECC[0]	G29	SSTL	I/O
DDR3_ECC[1]	J29	SSTL	I/O
DDR3_ECC[2]	E25	SSTL	I/O
DDR3_ECC[3]	C25	SSTL	I/O
DDR3_ECC[4]	F30	SSTL	I/O
DDR3_ECC[5]	H30	SSTL	I/O
DDR3_ECC[6]	F26	SSTL	I/O



Table 8-1. Land Name (Sheet 17 of 49)

Land Name	Land No.	Buffer Type	Direction
DDR3_ECC[7]	H26	SSTL	I/O
DDR3_MA_PAR	B18	SSTL	O
DDR3_MA[00]	A19	SSTL	O
DDR3_MA[01]	E21	SSTL	O
DDR3_MA[02]	F20	SSTL	O
DDR3_MA[03]	B20	SSTL	O
DDR3_MA[04]	D20	SSTL	O
DDR3_MA[05]	A21	SSTL	O
DDR3_MA[06]	F22	SSTL	O
DDR3_MA[07]	B22	SSTL	O
DDR3_MA[08]	D22	SSTL	O
DDR3_MA[09]	G23	SSTL	O
DDR3_MA[10]	D18	SSTL	O
DDR3_MA[11]	A23	SSTL	O
DDR3_MA[12]	E23	SSTL	O
DDR3_MA[13]	A13	SSTL	O
DDR3_MA[14]	D24	SSTL	O
DDR3_MA[15]	F24	SSTL	O
DDR3_ODT[0]	L19	SSTL	O
DDR3_ODT[1]	F18	SSTL	O
DDR3_ODT[2]	E17	SSTL	O
DDR3_ODT[3]	J17	SSTL	O
DDR3_ODT[4]	D14	SSTL	O
DDR3_ODT[5]	M16	SSTL	O
DDR3_PAR_ERR_N	G21	SSTL	I
DDR3_RAS_N	B16	SSTL	O
DDR3_WE_N	A15	SSTL	O
DMI_RX_DN[0]	E47	PCIEX	I
DMI_RX_DN[1]	D48	PCIEX	I
DMI_RX_DN[2]	E49	PCIEX	I
DMI_RX_DN[3]	D50	PCIEX	I
DMI_RX_DP[0]	C47	PCIEX	I
DMI_RX_DP[1]	B48	PCIEX	I
DMI_RX_DP[2]	C49	PCIEX	I
DMI_RX_DP[3]	B50	PCIEX	I
DMI_TX_DN[0]	D42	PCIEX	O
DMI_TX_DN[1]	E43	PCIEX	O
DMI_TX_DN[2]	D44	PCIEX	O
DMI_TX_DN[3]	E45	PCIEX	O
DMI_TX_DP[0]	B42	PCIEX	O
DMI_TX_DP[1]	C43	PCIEX	O
DMI_TX_DP[2]	B44	PCIEX	O

Table 8-1. Land Name (Sheet 18 of 49)

Land Name	Land No.	Buffer Type	Direction
DMI_TX_DP[3]	C45	PCIEX	O
TXT_PLTEN	V52	CMOS	I
DRAM_PWR_OK_C01	CW17	CMOS1.5v	I
DRAM_PWR_OK_C23	L15	CMOS1.5v	I
EAR_N	CH56	ODCMOS	I/O
ERROR_N[0]	BD50	ODCMOS	O
ERROR_N[1]	CB54	ODCMOS	O
ERROR_N[2]	BC51	ODCMOS	O
FRMAGENT	AT50	CMOS	I
IVT_ID_N	AH42		O
TXT_AGENT	AK52	CMOS	I
MEM_HOT_C01_N	CB22	ODCMOS	I/O
MEM_HOT_C23_N	E13	ODCMOS	I/O
PE_RBIAIS	AH52	PCIEX3	I/O
PE_RBIAIS_SENSE	AF52	PCIEX3	I
PE_VREF_CAP	AJ43	PCIEX3	I/O
PE1A_RX_DN[0]	E51	PCIEX3	I
PE1A_RX_DN[1]	F52	PCIEX3	I
PE1A_RX_DN[2]	F54	PCIEX3	I
PE1A_RX_DN[3]	G55	PCIEX3	I
PE1A_RX_DP[0]	C51	PCIEX3	I
PE1A_RX_DP[1]	D52	PCIEX3	I
PE1A_RX_DP[2]	D54	PCIEX3	I
PE1A_RX_DP[3]	E55	PCIEX3	I
PE1A_TX_DN[0]	K42	PCIEX3	O
PE1A_TX_DN[1]	L43	PCIEX3	O
PE1A_TX_DN[2]	K44	PCIEX3	O
PE1A_TX_DN[3]	L45	PCIEX3	O
PE1A_TX_DP[0]	H42	PCIEX3	O
PE1A_TX_DP[1]	J43	PCIEX3	O
PE1A_TX_DP[2]	H44	PCIEX3	O
PE1A_TX_DP[3]	J45	PCIEX3	O
PE1B_RX_DN[4]	L53	PCIEX3	I
PE1B_RX_DN[5]	M54	PCIEX3	I
PE1B_RX_DN[6]	L57	PCIEX3	I
PE1B_RX_DN[7]	M56	PCIEX3	I
PE1B_RX_DP[4]	J53	PCIEX3	I
PE1B_RX_DP[5]	K54	PCIEX3	I
PE1B_RX_DP[6]	J57	PCIEX3	I
PE1B_RX_DP[7]	K56	PCIEX3	I
PE1B_TX_DN[4]	K46	PCIEX3	O
PE1B_TX_DN[5]	L47	PCIEX3	O



Table 8-1. Land Name (Sheet 19 of 49)

Land Name	Land No.	Buffer Type	Direction
PE1B_TX_DN[6]	K48	PCIEX3	O
PE1B_TX_DN[7]	L49	PCIEX3	O
PE1B_TX_DP[4]	H46	PCIEX3	O
PE1B_TX_DP[5]	J47	PCIEX3	O
PE1B_TX_DP[6]	H48	PCIEX3	O
PE1B_TX_DP[7]	J49	PCIEX3	O
PE2A_RX_DN[0]	N55	PCIEX3	I
PE2A_RX_DN[1]	V54	PCIEX3	I
PE2A_RX_DN[2]	V56	PCIEX3	I
PE2A_RX_DN[3]	W55	PCIEX3	I
PE2A_RX_DP[0]	L55	PCIEX3	I
PE2A_RX_DP[1]	T54	PCIEX3	I
PE2A_RX_DP[2]	T56	PCIEX3	I
PE2A_RX_DP[3]	U55	PCIEX3	I
PE2A_TX_DN[0]	AR49	PCIEX3	O
PE2A_TX_DN[1]	AP50	PCIEX3	O
PE2A_TX_DN[2]	AR51	PCIEX3	O
PE2A_TX_DN[3]	AP52	PCIEX3	O
PE2A_TX_DP[0]	AN49	PCIEX3	O
PE2A_TX_DP[1]	AM50	PCIEX3	O
PE2A_TX_DP[2]	AN51	PCIEX3	O
PE2A_TX_DP[3]	AM52	PCIEX3	O
PE2B_RX_DN[4]	AD54	PCIEX3	I
PE2B_RX_DN[5]	AD56	PCIEX3	I
PE2B_RX_DN[6]	AE55	PCIEX3	I
PE2B_RX_DN[7]	AF58	PCIEX3	I
PE2B_RX_DP[4]	AB54	PCIEX3	I
PE2B_RX_DP[5]	AB56	PCIEX3	I
PE2B_RX_DP[6]	AC55	PCIEX3	I
PE2B_RX_DP[7]	AE57	PCIEX3	I
PE2B_TX_DN[4]	AJ53	PCIEX3	O
PE2B_TX_DN[5]	AK54	PCIEX3	O
PE2B_TX_DN[6]	AR53	PCIEX3	O
PE2B_TX_DN[7]	AT54	PCIEX3	O
PE2B_TX_DP[4]	AG53	PCIEX3	O
PE2B_TX_DP[5]	AH54	PCIEX3	O
PE2B_TX_DP[6]	AN53	PCIEX3	O
PE2B_TX_DP[7]	AP54	PCIEX3	O
PE2C_RX_DN[10]	AL57	PCIEX3	I
PE2C_RX_DN[11]	AU57	PCIEX3	I
PE2C_RX_DN[8]	AK56	PCIEX3	I
PE2C_RX_DN[9]	AM58	PCIEX3	I

Table 8-1. Land Name (Sheet 20 of 49)

Land Name	Land No.	Buffer Type	Direction
PE2C_RX_DP[10]	AJ57	PCIEX3	I
PE2C_RX_DP[11]	AR57	PCIEX3	I
PE2C_RX_DP[8]	AH56	PCIEX3	I
PE2C_RX_DP[9]	AK58	PCIEX3	I
PE2C_TX_DN[10]	BB54	PCIEX3	O
PE2C_TX_DN[11]	BA51	PCIEX3	O
PE2C_TX_DN[8]	AY52	PCIEX3	O
PE2C_TX_DN[9]	BA53	PCIEX3	O
PE2C_TX_DP[10]	AY54	PCIEX3	O
PE2C_TX_DP[11]	AW51	PCIEX3	O
PE2C_TX_DP[8]	AV52	PCIEX3	O
PE2C_TX_DP[9]	AW53	PCIEX3	O
PE2D_RX_DN[12]	AV58	PCIEX3	I
PE2D_RX_DN[13]	AT56	PCIEX3	I
PE2D_RX_DN[14]	BA57	PCIEX3	I
PE2D_RX_DN[15]	BB56	PCIEX3	I
PE2D_RX_DP[12]	AT58	PCIEX3	I
PE2D_RX_DP[13]	AP56	PCIEX3	I
PE2D_RX_DP[14]	AY58	PCIEX3	I
PE2D_RX_DP[15]	AY56	PCIEX3	I
PE2D_TX_DN[12]	AY50	PCIEX3	O
PE2D_TX_DN[13]	BA49	PCIEX3	O
PE2D_TX_DN[14]	AY48	PCIEX3	O
PE2D_TX_DN[15]	BA47	PCIEX3	O
PE2D_TX_DP[12]	AV50	PCIEX3	O
PE2D_TX_DP[13]	AW49	PCIEX3	O
PE2D_TX_DP[14]	AV48	PCIEX3	O
PE2D_TX_DP[15]	AW47	PCIEX3	O
PE3A_RX_DN[0]	AH44	PCIEX3	I
PE3A_RX_DN[1]	AJ45	PCIEX3	I
PE3A_RX_DN[2]	AH46	PCIEX3	I
PE3A_RX_DN[3]	AC49	PCIEX3	I
PE3A_RX_DP[0]	AF44	PCIEX3	I
PE3A_RX_DP[1]	AG45	PCIEX3	I
PE3A_RX_DP[2]	AF46	PCIEX3	I
PE3A_RX_DP[3]	AA49	PCIEX3	I
PE3A_TX_DN[0]	K50	PCIEX3	O
PE3A_TX_DN[1]	L51	PCIEX3	O
PE3A_TX_DN[2]	U47	PCIEX3	O
PE3A_TX_DN[3]	T48	PCIEX3	O
PE3A_TX_DP[0]	H50	PCIEX3	O
PE3A_TX_DP[1]	J51	PCIEX3	O



Table 8-1. Land Name (Sheet 21 of 49)

Land Name	Land No.	Buffer Type	Direction
PE3A_TX_DP[2]	R47	PCIEX3	O
PE3A_TX_DP[3]	P48	PCIEX3	O
PE3B_RX_DN[4]	AB50	PCIEX3	I
PE3B_RX_DN[5]	AB52	PCIEX3	I
PE3B_RX_DN[6]	AC53	PCIEX3	I
PE3B_RX_DN[7]	AC51	PCIEX3	I
PE3B_RX_DP[4]	Y50	PCIEX3	I
PE3B_RX_DP[5]	Y52	PCIEX3	I
PE3B_RX_DP[6]	AA53	PCIEX3	I
PE3B_RX_DP[7]	AA51	PCIEX3	I
PE3B_TX_DN[4]	T52	PCIEX3	O
PE3B_TX_DN[5]	U51	PCIEX3	O
PE3B_TX_DN[6]	T50	PCIEX3	O
PE3B_TX_DN[7]	U49	PCIEX3	O
PE3B_TX_DP[4]	P52	PCIEX3	O
PE3B_TX_DP[5]	R51	PCIEX3	O
PE3B_TX_DP[6]	P50	PCIEX3	O
PE3B_TX_DP[7]	R49	PCIEX3	O
PE3C_RX_DN[10]	AH50	PCIEX3	I
PE3C_RX_DN[11]	AJ49	PCIEX3	I
PE3C_RX_DN[8]	AH48	PCIEX3	I
PE3C_RX_DN[9]	AJ51	PCIEX3	I
PE3C_RX_DP[10]	AF50	PCIEX3	I
PE3C_RX_DP[11]	AG49	PCIEX3	I
PE3C_RX_DP[8]	AF48	PCIEX3	I
PE3C_RX_DP[9]	AG51	PCIEX3	I
PE3C_TX_DN[10]	U45	PCIEX3	O
PE3C_TX_DN[11]	AB46	PCIEX3	O
PE3C_TX_DN[8]	T46	PCIEX3	O
PE3C_TX_DN[9]	AC47	PCIEX3	O
PE3C_TX_DP[10]	R45	PCIEX3	O
PE3C_TX_DP[11]	Y46	PCIEX3	O
PE3C_TX_DP[8]	P46	PCIEX3	O
PE3C_TX_DP[9]	AA47	PCIEX3	O
PE3D_RX_DN[12]	AJ47	PCIEX3	I
PE3D_RX_DN[13]	AR47	PCIEX3	I
PE3D_RX_DN[14]	AP46	PCIEX3	I
PE3D_RX_DN[15]	AR45	PCIEX3	I
PE3D_RX_DP[12]	AG47	PCIEX3	I
PE3D_RX_DP[13]	AN47	PCIEX3	I
PE3D_RX_DP[14]	AM46	PCIEX3	I
PE3D_RX_DP[15]	AN45	PCIEX3	I

Table 8-1. Land Name (Sheet 22 of 49)

Land Name	Land No.	Buffer Type	Direction
PE3D_TX_DN[12]	AC45	PCIEX3	O
PE3D_TX_DN[13]	AB44	PCIEX3	O
PE3D_TX_DN[14]	AA43	PCIEX3	O
PE3D_TX_DN[15]	P44	PCIEX3	O
PE3D_TX_DP[12]	AA45	PCIEX3	O
PE3D_TX_DP[13]	Y44	PCIEX3	O
PE3D_TX_DP[14]	AC43	PCIEX3	O
PE3D_TX_DP[15]	T44	PCIEX3	O
PECI	BJ47	PECI	I/O
PEHPSCL	BH48	ODCMOS	I/O
PEHPSDA	BF48	ODCMOS	I/O
PMSYNC	K52	CMOS	I
PRDY_N	R53	CMOS	O
PREQ_N	U53	CMOS	I/O
PROCHOT_N	BD52	ODCMOS	I/O
PWRGOOD	BJ53	CMOS	I
QPI_RBIAIS	CE53	Analog	I/O
QPI_RBIAIS_SENSE	CC53	Analog	I
QPI_VREF_CAP	CU51	QPI	I/O
QPIO_CLKRX_DN	BM58	QPI	I
QPIO_CLKRX_DP	BK58	QPI	I
QPIO_CLKTX_DN	CG45	QPI	O
QPIO_CLKTX_DP	CE45	QPI	O
QPIO_DRX_DN[00]	BJ51	QPI	I
QPIO_DRX_DN[01]	BH52	QPI	I
QPIO_DRX_DN[02]	BG53	QPI	I
QPIO_DRX_DN[03]	BG55	QPI	I
QPIO_DRX_DN[04]	BH56	QPI	I
QPIO_DRX_DN[05]	BH54	QPI	I
QPIO_DRX_DN[06]	BH50	QPI	I
QPIO_DRX_DN[07]	BF58	QPI	I
QPIO_DRX_DN[08]	BG57	QPI	I
QPIO_DRX_DN[09]	BN57	QPI	I
QPIO_DRX_DN[10]	BP56	QPI	I
QPIO_DRX_DN[11]	BN55	QPI	I
QPIO_DRX_DN[12]	BP54	QPI	I
QPIO_DRX_DN[13]	BN53	QPI	I
QPIO_DRX_DN[14]	BP52	QPI	I
QPIO_DRX_DN[15]	BR51	QPI	I
QPIO_DRX_DN[16]	BP50	QPI	I
QPIO_DRX_DN[17]	BJ49	QPI	I
QPIO_DRX_DN[18]	BN49	QPI	I



Table 8-1. Land Name (Sheet 23 of 49)

Land Name	Land No.	Buffer Type	Direction
QPI0_DRX_DN[19]	BM48	QPI	I
QPI0_DRX_DP[00]	BG51	QPI	I
QPI0_DRX_DP[01]	BF52	QPI	I
QPI0_DRX_DP[02]	BE53	QPI	I
QPI0_DRX_DP[03]	BE55	QPI	I
QPI0_DRX_DP[04]	BF56	QPI	I
QPI0_DRX_DP[05]	BF54	QPI	I
QPI0_DRX_DP[06]	BF50	QPI	I
QPI0_DRX_DP[07]	BD58	QPI	I
QPI0_DRX_DP[08]	BE57	QPI	I
QPI0_DRX_DP[09]	BL57	QPI	I
QPI0_DRX_DP[10]	BM56	QPI	I
QPI0_DRX_DP[11]	BL55	QPI	I
QPI0_DRX_DP[12]	BM54	QPI	I
QPI0_DRX_DP[13]	BL53	QPI	I
QPI0_DRX_DP[14]	BM52	QPI	I
QPI0_DRX_DP[15]	BN51	QPI	I
QPI0_DRX_DP[16]	BM50	QPI	I
QPI0_DRX_DP[17]	BG49	QPI	I
QPI0_DRX_DP[18]	BR49	QPI	I
QPI0_DRX_DP[19]	BP48	QPI	I
QPI0_DTX_DN[00]	BW49	QPI	O
QPI0_DTX_DN[01]	BW51	QPI	O
QPI0_DTX_DN[02]	BW53	QPI	O
QPI0_DTX_DN[03]	BY54	QPI	O
QPI0_DTX_DN[04]	BW55	QPI	O
QPI0_DTX_DN[05]	BV58	QPI	O
QPI0_DTX_DN[06]	BW47	QPI	O
QPI0_DTX_DN[07]	BW57	QPI	O
QPI0_DTX_DN[08]	BY56	QPI	O
QPI0_DTX_DN[09]	BW45	QPI	O
QPI0_DTX_DN[10]	CF46	QPI	O
QPI0_DTX_DN[11]	BY52	QPI	O
QPI0_DTX_DN[12]	CA47	QPI	O
QPI0_DTX_DN[13]	CA49	QPI	O
QPI0_DTX_DN[14]	CG47	QPI	O
QPI0_DTX_DN[15]	CF48	QPI	O
QPI0_DTX_DN[16]	CF50	QPI	O
QPI0_DTX_DN[17]	CF52	QPI	O
QPI0_DTX_DN[18]	CG51	QPI	O
QPI0_DTX_DN[19]	CG49	QPI	O
QPI0_DTX_DP[00]	BV50	QPI	O

Table 8-1. Land Name (Sheet 24 of 49)

Land Name	Land No.	Buffer Type	Direction
QPI0_DTX_DP[01]	BV52	QPI	O
QPI0_DTX_DP[02]	BU53	QPI	O
QPI0_DTX_DP[03]	BV54	QPI	O
QPI0_DTX_DP[04]	BU55	QPI	O
QPI0_DTX_DP[05]	BT58	QPI	O
QPI0_DTX_DP[06]	BV48	QPI	O
QPI0_DTX_DP[07]	BU57	QPI	O
QPI0_DTX_DP[08]	BV56	QPI	O
QPI0_DTX_DP[09]	BV46	QPI	O
QPI0_DTX_DP[10]	CD46	QPI	O
QPI0_DTX_DP[11]	CA51	QPI	O
QPI0_DTX_DP[12]	BY48	QPI	O
QPI0_DTX_DP[13]	BY50	QPI	O
QPI0_DTX_DP[14]	CE47	QPI	O
QPI0_DTX_DP[15]	CD48	QPI	O
QPI0_DTX_DP[16]	CD50	QPI	O
QPI0_DTX_DP[17]	CD52	QPI	O
QPI0_DTX_DP[18]	CE51	QPI	O
QPI0_DTX_DP[19]	CE49	QPI	O
QPI1_CLKRX_DN	CU55	QPI	I
QPI1_CLKRX_DP	CR55	QPI	I
QPI1_CLKTX_DN	CY54	QPI	O
QPI1_CLKTX_DP	DB54	QPI	O
QPI1_DRX_DN[00]	CE55	QPI	I
QPI1_DRX_DN[01]	CF56	QPI	I
QPI1_DRX_DN[02]	CF54	QPI	I
QPI1_DRX_DN[03]	CL55	QPI	I
QPI1_DRX_DN[04]	CM56	QPI	I
QPI1_DRX_DN[05]	CM54	QPI	I
QPI1_DRX_DN[06]	CT58	QPI	I
QPI1_DRX_DN[07]	CU57	QPI	I
QPI1_DRX_DN[08]	CV56	QPI	I
QPI1_DRX_DN[09]	CL53	QPI	I
QPI1_DRX_DN[10]	CM52	QPI	I
QPI1_DRX_DN[11]	CR53	QPI	I
QPI1_DRX_DN[12]	CT52	QPI	I
QPI1_DRX_DN[13]	CL51	QPI	I
QPI1_DRX_DN[14]	CK50	QPI	I
QPI1_DRX_DN[15]	CL49	QPI	I
QPI1_DRX_DN[16]	CM48	QPI	I
QPI1_DRX_DN[17]	CN47	QPI	I
QPI1_DRX_DN[18]	CM46	QPI	I



Table 8-1. Land Name (Sheet 25 of 49)

Land Name	Land No.	Buffer Type	Direction
QPI1_DRX_DN[19]	CN45	QPI	I
QPI1_DRX_DP[00]	CC55	QPI	I
QPI1_DRX_DP[01]	CD56	QPI	I
QPI1_DRX_DP[02]	CD54	QPI	I
QPI1_DRX_DP[03]	CJ55	QPI	I
QPI1_DRX_DP[04]	CK56	QPI	I
QPI1_DRX_DP[05]	CK54	QPI	I
QPI1_DRX_DP[06]	CP58	QPI	I
QPI1_DRX_DP[07]	CR57	QPI	I
QPI1_DRX_DP[08]	CT56	QPI	I
QPI1_DRX_DP[09]	CJ53	QPI	I
QPI1_DRX_DP[10]	CK52	QPI	I
QPI1_DRX_DP[11]	CU53	QPI	I
QPI1_DRX_DP[12]	CV52	QPI	I
QPI1_DRX_DP[13]	CN51	QPI	I
QPI1_DRX_DP[14]	CM50	QPI	I
QPI1_DRX_DP[15]	CN49	QPI	I
QPI1_DRX_DP[16]	CK48	QPI	I
QPI1_DRX_DP[17]	CL47	QPI	I
QPI1_DRX_DP[18]	CK46	QPI	I
QPI1_DRX_DP[19]	CL45	QPI	I
QPI1_DTX_DN[00]	CV48	QPI	O
QPI1_DTX_DN[01]	CV50	QPI	O
QPI1_DTX_DN[02]	CW49	QPI	O
QPI1_DTX_DN[03]	DC53	QPI	O
QPI1_DTX_DN[04]	DB52	QPI	O
QPI1_DTX_DN[05]	CW47	QPI	O
QPI1_DTX_DN[06]	DE51	QPI	O
QPI1_DTX_DN[07]	DB50	QPI	O
QPI1_DTX_DN[08]	CV46	QPI	O
QPI1_DTX_DN[09]	DE49	QPI	O
QPI1_DTX_DN[10]	DD48	QPI	O
QPI1_DTX_DN[11]	CW45	QPI	O
QPI1_DTX_DN[12]	DC47	QPI	O
QPI1_DTX_DN[13]	DD46	QPI	O
QPI1_DTX_DN[14]	CV44	QPI	O
QPI1_DTX_DN[15]	DC45	QPI	O
QPI1_DTX_DN[16]	DD44	QPI	O
QPI1_DTX_DN[17]	CW43	QPI	O
QPI1_DTX_DN[18]	DC43	QPI	O
QPI1_DTX_DN[19]	DD42	QPI	O
QPI1_DTX_DP[00]	CT48	QPI	O

Table 8-1. Land Name (Sheet 26 of 49)

Land Name	Land No.	Buffer Type	Direction
QPI1_DTX_DP[01]	CT50	QPI	O
QPI1_DTX_DP[02]	CU49	QPI	O
QPI1_DTX_DP[03]	DA53	QPI	O
QPI1_DTX_DP[04]	DD52	QPI	O
QPI1_DTX_DP[05]	CU47	QPI	O
QPI1_DTX_DP[06]	DC51	QPI	O
QPI1_DTX_DP[07]	DD50	QPI	O
QPI1_DTX_DP[08]	CT46	QPI	O
QPI1_DTX_DP[09]	DC49	QPI	O
QPI1_DTX_DP[10]	DB48	QPI	O
QPI1_DTX_DP[11]	CU45	QPI	O
QPI1_DTX_DP[12]	DE47	QPI	O
QPI1_DTX_DP[13]	DB46	QPI	O
QPI1_DTX_DP[14]	CT44	QPI	O
QPI1_DTX_DP[15]	DE45	QPI	O
QPI1_DTX_DP[16]	DB44	QPI	O
QPI1_DTX_DP[17]	CU43	QPI	O
QPI1_DTX_DP[18]	DE43	QPI	O
QPI1_DTX_DP[19]	DB42	QPI	O
RESET_N	CK44	CMOS	I
RSVD	A53		
RSVD	AB48		
RSVD	AJ55		
RSVD	AL55		
RSVD	AM44		
RSVD	AP48		
RSVD	AR55		
RSVD	AU55		
RSVD	AV46		
RSVD	AY46		
RSVD	B46		
RSVD	BC47		
RSVD	BD44		
RSVD	BD46		
RSVD	BD48		
RSVD	BE43		
RSVD	BE45		
RSVD	BE47		
RSVD	BF46		
RSVD	BG43		
RSVD	BG45		
RSVD	BH44		



Table 8-1. Land Name (Sheet 27 of 49)

Land Name	Land No.	Buffer Type	Direction
RSVD	BH46		
RSVD	BJ43		
RSVD	BJ45		
RSVD	BK44		
RSVD	BL43		
RSVD	BL45		
RSVD	BM44		
RSVD	BM46		
RSVD	BN47		
RSVD	BP44		
RSVD	BP46		
RSVD	BR43		
RSVD	BR47		
RSVD	BT44		
RSVD	BU43		
RSVD	BY46		
RSVD	C53		
RSVD	CA45		
RSVD	CD44		
RSVD	CE43		
RSVD	CF44		
RSVD	CG11		
RSVD	CP54		
RSVD	CY46		
RSVD	CY48		
RSVD	CY56		
RSVD	CY58		
RSVD	D46		
RSVD	D56		
RSVD	DA57		
RSVD	DB56		
RSVD	DC55		
RSVD	DD54		
RSVD	DE55		
RSVD	E53		
RSVD	E57		
RSVD	F46		
RSVD	F56		
RSVD	F58		
RSVD	H56		
RSVD	H58		
RSVD	J15		

Table 8-1. Land Name (Sheet 28 of 49)

Land Name	Land No.	Buffer Type	Direction
RSVD	K58		
RSVD	M48		
RSVD	W15		
RSVD	Y48		
SAFE_MODE_BOOT	DA55	CMOS	I
SKTOCC_N	BU49		O
SOCKET_ID[0]	CY52	CMOS	I
SOCKET_ID[1]	BC49	CMOS	I
SVIDALERT_N	CR43	CMOS	I
SVIDCLK	CB44	ODCMOS	O
SVIDDATA	BR45	ODCMOS	I/O
TCK	BY44	CMOS	I
TDI	BW43	CMOS	I
TDO	CA43	ODCMOS	O
TEST0	DB4		O
TEST1	CW1		O
TEST2	F2		O
TEST3	D4		O
TEST4	BA55		I
THERMTRIP_N	BL47	ODCMOS	O
TMS	BV44	CMOS	I
TRST_N	CT54	CMOS	I
VCC	AG19	PWR	
VCC	AG25	PWR	
VCC	AG27	PWR	
VCC	AG29	PWR	
VCC	AG31	PWR	
VCC	AG33	PWR	
VCC	AG35	PWR	
VCC	AG37	PWR	
VCC	AG39	PWR	
VCC	AG41	PWR	
VCC	AL1	PWR	
VCC	AL11	PWR	
VCC	AL13	PWR	
VCC	AL15	PWR	
VCC	AL17	PWR	
VCC	AL3	PWR	
VCC	AL5	PWR	
VCC	AL7	PWR	
VCC	AL9	PWR	
VCC	AM10	PWR	



Table 8-1. Land Name (Sheet 29 of 49)

Land Name	Land No.	Buffer Type	Direction
VCC	AM12	PWR	
VCC	AM14	PWR	
VCC	AM16	PWR	
VCC	AM2	PWR	
VCC	AM4	PWR	
VCC	AM6	PWR	
VCC	AM8	PWR	
VCC	AN1	PWR	
VCC	AN11	PWR	
VCC	AN13	PWR	
VCC	AN15	PWR	
VCC	AN17	PWR	
VCC	AN3	PWR	
VCC	AN5	PWR	
VCC	AN7	PWR	
VCC	AN9	PWR	
VCC	AP10	PWR	
VCC	AP12	PWR	
VCC	AP14	PWR	
VCC	AP16	PWR	
VCC	AP2	PWR	
VCC	AP4	PWR	
VCC	AP6	PWR	
VCC	AP8	PWR	
VCC	AU1	PWR	
VCC	AU11	PWR	
VCC	AU13	PWR	
VCC	AU15	PWR	
VCC	AU17	PWR	
VCC	AU3	PWR	
VCC	AU5	PWR	
VCC	AU7	PWR	
VCC	AU9	PWR	
VCC	AV10	PWR	
VCC	AV12	PWR	
VCC	AV14	PWR	
VCC	AV16	PWR	
VCC	AV2	PWR	
VCC	AV4	PWR	
VCC	AV6	PWR	
VCC	AV8	PWR	
VCC	AW1	PWR	

Table 8-1. Land Name (Sheet 30 of 49)

Land Name	Land No.	Buffer Type	Direction
VCC	AW11	PWR	
VCC	AW13	PWR	
VCC	AW15	PWR	
VCC	AW17	PWR	
VCC	AW3	PWR	
VCC	AW5	PWR	
VCC	AW7	PWR	
VCC	AW9	PWR	
VCC	AY10	PWR	
VCC	AY12	PWR	
VCC	AY14	PWR	
VCC	AY16	PWR	
VCC	AY2	PWR	
VCC	AY4	PWR	
VCC	AY6	PWR	
VCC	AY8	PWR	
VCC	BA1	PWR	
VCC	BA11	PWR	
VCC	BA13	PWR	
VCC	BA15	PWR	
VCC	BA17	PWR	
VCC	BA3	PWR	
VCC	BA5	PWR	
VCC	BA7	PWR	
VCC	BA9	PWR	
VCC	BB10	PWR	
VCC	BB12	PWR	
VCC	BB14	PWR	
VCC	BB16	PWR	
VCC	BB2	PWR	
VCC	BB4	PWR	
VCC	BB6	PWR	
VCC	BB8	PWR	
VCC	BE1	PWR	
VCC	BE11	PWR	
VCC	BE13	PWR	
VCC	BE15	PWR	
VCC	BE17	PWR	
VCC	BE3	PWR	
VCC	BE5	PWR	
VCC	BE7	PWR	
VCC	BE9	PWR	



Table 8-1. Land Name (Sheet 31 of 49)

Land Name	Land No.	Buffer Type	Direction
VCC	BF10	PWR	
VCC	BF12	PWR	
VCC	BF14	PWR	
VCC	BF16	PWR	
VCC	BF2	PWR	
VCC	BF4	PWR	
VCC	BF6	PWR	
VCC	BF8	PWR	
VCC	BG1	PWR	
VCC	BG11	PWR	
VCC	BG13	PWR	
VCC	BG15	PWR	
VCC	BG17	PWR	
VCC	BG3	PWR	
VCC	BG5	PWR	
VCC	BG7	PWR	
VCC	BG9	PWR	
VCC	BH10	PWR	
VCC	BH12	PWR	
VCC	BH14	PWR	
VCC	BH16	PWR	
VCC	BH2	PWR	
VCC	BH4	PWR	
VCC	BH6	PWR	
VCC	BH8	PWR	
VCC	BJ1	PWR	
VCC	BJ11	PWR	
VCC	BJ13	PWR	
VCC	BJ15	PWR	
VCC	BJ17	PWR	
VCC	BJ3	PWR	
VCC	BJ5	PWR	
VCC	BJ7	PWR	
VCC	BJ9	PWR	
VCC	BK10	PWR	
VCC	BK12	PWR	
VCC	BK14	PWR	
VCC	BK16	PWR	
VCC	BK2	PWR	
VCC	BK4	PWR	
VCC	BK6	PWR	
VCC	BK8	PWR	

Table 8-1. Land Name (Sheet 32 of 49)

Land Name	Land No.	Buffer Type	Direction
VCC	BN1	PWR	
VCC	BN11	PWR	
VCC	BN13	PWR	
VCC	BN15	PWR	
VCC	BN17	PWR	
VCC	BN3	PWR	
VCC	BN5	PWR	
VCC	BN7	PWR	
VCC	BN9	PWR	
VCC	BP10	PWR	
VCC	BP12	PWR	
VCC	BP14	PWR	
VCC	BP16	PWR	
VCC	BP2	PWR	
VCC	BP4	PWR	
VCC	BP6	PWR	
VCC	BP8	PWR	
VCC	BR1	PWR	
VCC	BR11	PWR	
VCC	BR13	PWR	
VCC	BR15	PWR	
VCC	BR17	PWR	
VCC	BR3	PWR	
VCC	BR5	PWR	
VCC	BR7	PWR	
VCC	BR9	PWR	
VCC	BT10	PWR	
VCC	BT12	PWR	
VCC	BT14	PWR	
VCC	BT16	PWR	
VCC	BT2	PWR	
VCC	BT4	PWR	
VCC	BT6	PWR	
VCC	BT8	PWR	
VCC	BU1	PWR	
VCC	BU11	PWR	
VCC	BU13	PWR	
VCC	BU15	PWR	
VCC	BU17	PWR	
VCC	BU3	PWR	
VCC	BU5	PWR	
VCC	BU7	PWR	



Table 8-1. Land Name (Sheet 33 of 49)

Land Name	Land No.	Buffer Type	Direction
VCC	BU9	PWR	
VCC	BV10	PWR	
VCC	BV12	PWR	
VCC	BV14	PWR	
VCC	BV16	PWR	
VCC	BV2	PWR	
VCC	BV4	PWR	
VCC	BV6	PWR	
VCC	BV8	PWR	
VCC	BY18	PWR	
VCC	BY26	PWR	
VCC	BY28	PWR	
VCC	BY30	PWR	
VCC	BY32	PWR	
VCC	BY34	PWR	
VCC	BY36	PWR	
VCC	BY38	PWR	
VCC	BY40	PWR	
VCC	CA25	PWR	
VCC	CA29	PWR	
VCC_SENSE	BW3		O
VCCD_01	CD20	PWR	
VCCD_01	CD22	PWR	
VCCD_01	CD24	PWR	
VCCD_01	CD26	PWR	
VCCD_01	CD28	PWR	
VCCD_01	CJ19	PWR	
VCCD_01	CJ21	PWR	
VCCD_01	CJ23	PWR	
VCCD_01	CJ25	PWR	
VCCD_01	CJ27	PWR	
VCCD_01	CP20	PWR	
VCCD_01	CP22	PWR	
VCCD_01	CP24	PWR	
VCCD_01	CP26	PWR	
VCCD_01	CP28	PWR	
VCCD_01	CW19	PWR	
VCCD_01	CW21	PWR	
VCCD_01	CW23	PWR	
VCCD_01	CW25	PWR	
VCCD_01	CW27	PWR	
VCCD_01	DD18	PWR	

Table 8-1. Land Name (Sheet 34 of 49)

Land Name	Land No.	Buffer Type	Direction
VCCD_01	DD20	PWR	
VCCD_01	DD22	PWR	
VCCD_01	DD24	PWR	
VCCD_01	DD26	PWR	
VCCD_23	AC17	PWR	
VCCD_23	AC19	PWR	
VCCD_23	AC21	PWR	
VCCD_23	AC23	PWR	
VCCD_23	AC25	PWR	
VCCD_23	C15	PWR	
VCCD_23	C17	PWR	
VCCD_23	C19	PWR	
VCCD_23	C21	PWR	
VCCD_23	C23	PWR	
VCCD_23	G13	PWR	
VCCD_23	H16	PWR	
VCCD_23	H18	PWR	
VCCD_23	H20	PWR	
VCCD_23	H22	PWR	
VCCD_23	H24	PWR	
VCCD_23	N15	PWR	
VCCD_23	N17	PWR	
VCCD_23	N19	PWR	
VCCD_23	N21	PWR	
VCCD_23	N23	PWR	
VCCD_23	V16	PWR	
VCCD_23	V18	PWR	
VCCD_23	V20	PWR	
VCCD_23	V22	PWR	
VCCD_23	V24	PWR	
VCCPLL	BY14	PWR	
VCCPLL	CA13	PWR	
VCCPLL	CA15	PWR	
VSA	AE15	PWR	
VSA	AE17	PWR	
VSA	AF18	PWR	
VSA	AG15	PWR	
VSA	AG17	PWR	
VSA	AH10	PWR	
VSA	AH12	PWR	
VSA	AH14	PWR	
VSA	AH16	PWR	



Table 8-1. Land Name (Sheet 35 of 49)

Land Name	Land No.	Buffer Type	Direction
VSA	AH2	PWR	
VSA	AH4	PWR	
VSA	AH6	PWR	
VSA	AH8	PWR	
VSA	AJ1	PWR	
VSA	AJ11	PWR	
VSA	AJ13	PWR	
VSA	AJ3	PWR	
VSA	AJ5	PWR	
VSA	AJ7	PWR	
VSA	AJ9	PWR	
VSA	B54	PWR	
VSA	G43	PWR	
VSA	G49	PWR	
VSA	N45	PWR	
VSA	N51	PWR	
VSA_SENSE	AG13		O
VSS	A41	GND	
VSS	A43	GND	
VSS	A45	GND	
VSS	A47	GND	
VSS	A49	GND	
VSS	A5	GND	
VSS	A51	GND	
VSS	A7	GND	
VSS	AA11	GND	
VSS	AA29	GND	
VSS	AA3	GND	
VSS	AA31	GND	
VSS	AA39	GND	
VSS	AA5	GND	
VSS	AA55	GND	
VSS	AA9	GND	
VSS	AB14	GND	
VSS	AB36	GND	
VSS	AB42	GND	
VSS	AB6	GND	
VSS	AC31	GND	
VSS	AC9	GND	
VSS	AD26	GND	
VSS	AD34	GND	
VSS	AD36	GND	

Table 8-1. Land Name (Sheet 36 of 49)

Land Name	Land No.	Buffer Type	Direction
VSS	AD42	GND	
VSS	AD44	GND	
VSS	AD46	GND	
VSS	AD48	GND	
VSS	AD50	GND	
VSS	AD52	GND	
VSS	AD6	GND	
VSS	AE29	GND	
VSS	AE31	GND	
VSS	AE39	GND	
VSS	AE43	GND	
VSS	AE47	GND	
VSS	AE49	GND	
VSS	AE51	GND	
VSS	AE9	GND	
VSS	AF12	GND	
VSS	AF16	GND	
VSS	AF20	GND	
VSS	AF26	GND	
VSS	AF34	GND	
VSS	AF36	GND	
VSS	AF40	GND	
VSS	AF42	GND	
VSS	AF54	GND	
VSS	AF56	GND	
VSS	AF6	GND	
VSS	AG1	GND	
VSS	AG3	GND	
VSS	AG43	GND	
VSS	AG5	GND	
VSS	AG55	GND	
VSS	AG57	GND	
VSS	AG9	GND	
VSS	AH58	GND	
VSS	AJ15	GND	
VSS	AJ17	GND	
VSS	AK10	GND	
VSS	AK12	GND	
VSS	AK14	GND	
VSS	AK16	GND	
VSS	AK2	GND	
VSS	AK4	GND	



Table 8-1. Land Name (Sheet 37 of 49)

Land Name	Land No.	Buffer Type	Direction
VSS	AK42	GND	
VSS	AK44	GND	
VSS	AK46	GND	
VSS	AK48	GND	
VSS	AK50	GND	
VSS	AK6	GND	
VSS	AK8	GND	
VSS	AL43	GND	
VSS	AL45	GND	
VSS	AL49	GND	
VSS	AL51	GND	
VSS	AL53	GND	
VSS	AM56	GND	
VSS	AN55	GND	
VSS	AN57	GND	
VSS	AP42	GND	
VSS	AP44	GND	
VSS	AP58	GND	
VSS	AR1	GND	
VSS	AR11	GND	
VSS	AR13	GND	
VSS	AR15	GND	
VSS	AR17	GND	
VSS	AR3	GND	
VSS	AR5	GND	
VSS	AR7	GND	
VSS	AR9	GND	
VSS	AT10	GND	
VSS	AT12	GND	
VSS	AT14	GND	
VSS	AT16	GND	
VSS	AT2	GND	
VSS	AT4	GND	
VSS	AT46	GND	
VSS	AT52	GND	
VSS	AT6	GND	
VSS	AT8	GND	
VSS	AU45	GND	
VSS	AU47	GND	
VSS	AU49	GND	
VSS	AU51	GND	
VSS	AV42	GND	

Table 8-1. Land Name (Sheet 38 of 49)

Land Name	Land No.	Buffer Type	Direction
VSS	AV54	GND	
VSS	AV56	GND	
VSS	AW55	GND	
VSS	AW57	GND	
VSS	B36	GND	
VSS	B52	GND	
VSS	B6	GND	
VSS	B8	GND	
VSS	BB42	GND	
VSS	BB46	GND	
VSS	BB48	GND	
VSS	BB50	GND	
VSS	BB52	GND	
VSS	BB58	GND	
VSS	BC1	GND	
VSS	BC11	GND	
VSS	BC13	GND	
VSS	BC15	GND	
VSS	BC17	GND	
VSS	BC3	GND	
VSS	BC43	GND	
VSS	BC45	GND	
VSS	BC5	GND	
VSS	BC53	GND	
VSS	BC55	GND	
VSS	BC57	GND	
VSS	BC7	GND	
VSS	BC9	GND	
VSS	BD10	GND	
VSS	BD12	GND	
VSS	BD14	GND	
VSS	BD16	GND	
VSS	BD2	GND	
VSS	BD4	GND	
VSS	BD54	GND	
VSS	BD56	GND	
VSS	BD6	GND	
VSS	BD8	GND	
VSS	BE49	GND	
VSS	BE51	GND	
VSS	BF42	GND	
VSS	BF44	GND	



Table 8-1. Land Name (Sheet 39 of 49)

Land Name	Land No.	Buffer Type	Direction
VSS	BG47	GND	
VSS	BH58	GND	
VSS	BJ55	GND	
VSS	BJ57	GND	
VSS	BK42	GND	
VSS	BK46	GND	
VSS	BK48	GND	
VSS	BK50	GND	
VSS	BK52	GND	
VSS	BK54	GND	
VSS	BL1	GND	
VSS	BL11	GND	
VSS	BL13	GND	
VSS	BL15	GND	
VSS	BL17	GND	
VSS	BL3	GND	
VSS	BL49	GND	
VSS	BL5	GND	
VSS	BL7	GND	
VSS	BL9	GND	
VSS	BM10	GND	
VSS	BM12	GND	
VSS	BM14	GND	
VSS	BM16	GND	
VSS	BM2	GND	
VSS	BM4	GND	
VSS	BM6	GND	
VSS	BM8	GND	
VSS	BN43	GND	
VSS	BN45	GND	
VSS	BP58	GND	
VSS	BR53	GND	
VSS	BR57	GND	
VSS	BT46	GND	
VSS	BT48	GND	
VSS	BT50	GND	
VSS	BT52	GND	
VSS	BT54	GND	
VSS	BT56	GND	
VSS	BU45	GND	
VSS	BU51	GND	
VSS	BW1	GND	

Table 8-1. Land Name (Sheet 40 of 49)

Land Name	Land No.	Buffer Type	Direction
VSS	BW11	GND	
VSS	BW13	GND	
VSS	BW15	GND	
VSS	BW17	GND	
VSS	BW5	GND	
VSS	BW7	GND	
VSS	BY24	GND	
VSS	BY4	GND	
VSS	BY42	GND	
VSS	BY58	GND	
VSS	BY8	GND	
VSS	C11	GND	
VSS	C13	GND	
VSS	C3	GND	
VSS	C33	GND	
VSS	C39	GND	
VSS	C41	GND	
VSS	C5	GND	
VSS	C55	GND	
VSS	CA11	GND	
VSS	CA19	GND	
VSS	CA27	GND	
VSS	CA31	GND	
VSS	CA33	GND	
VSS	CA35	GND	
VSS	CA37	GND	
VSS	CA39	GND	
VSS	CA41	GND	
VSS	CA5	GND	
VSS	CA55	GND	
VSS	CA57	GND	
VSS	CB16	GND	
VSS	CB36	GND	
VSS	CB46	GND	
VSS	CB48	GND	
VSS	CB50	GND	
VSS	CB52	GND	
VSS	CB56	GND	
VSS	CB6	GND	
VSS	CB8	GND	
VSS	CC13	GND	
VSS	CC29	GND	



Table 8-1. Land Name (Sheet 41 of 49)

Land Name	Land No.	Buffer Type	Direction
VSS	CC3	GND	
VSS	CC43	GND	
VSS	CC47	GND	
VSS	CC49	GND	
VSS	CC9	GND	
VSS	CD18	GND	
VSS	CD36	GND	
VSS	CD6	GND	
VSS	CE13	GND	
VSS	CE5	GND	
VSS	CE9	GND	
VSS	CF12	GND	
VSS	CF14	GND	
VSS	CF30	GND	
VSS	CF32	GND	
VSS	CF34	GND	
VSS	CF36	GND	
VSS	CF38	GND	
VSS	CF40	GND	
VSS	CF42	GND	
VSS	CF6	GND	
VSS	CG15	GND	
VSS	CG31	GND	
VSS	CG33	GND	
VSS	CG35	GND	
VSS	CG37	GND	
VSS	CG39	GND	
VSS	CG41	GND	
VSS	CG43	GND	
VSS	CG53	GND	
VSS	CG9	GND	
VSS	CH12	GND	
VSS	CH16	GND	
VSS	CH36	GND	
VSS	CH44	GND	
VSS	CH46	GND	
VSS	CH48	GND	
VSS	CH50	GND	
VSS	CH52	GND	
VSS	CH54	GND	
VSS	CH6	GND	
VSS	CJ11	GND	

Table 8-1. Land Name (Sheet 42 of 49)

Land Name	Land No.	Buffer Type	Direction
VSS	CJ17	GND	
VSS	CJ29	GND	
VSS	CJ3	GND	
VSS	CJ43	GND	
VSS	CJ45	GND	
VSS	CJ47	GND	
VSS	CJ51	GND	
VSS	CJ9	GND	
VSS	CK10	GND	
VSS	CK36	GND	
VSS	CK4	GND	
VSS	CK6	GND	
VSS	CL17	GND	
VSS	CL43	GND	
VSS	CL5	GND	
VSS	CM10	GND	
VSS	CM14	GND	
VSS	CM30	GND	
VSS	CM32	GND	
VSS	CM34	GND	
VSS	CM36	GND	
VSS	CM38	GND	
VSS	CM40	GND	
VSS	CM42	GND	
VSS	CM6	GND	
VSS	CM8	GND	
VSS	CN11	GND	
VSS	CN13	GND	
VSS	CN15	GND	
VSS	CN17	GND	
VSS	CN3	GND	
VSS	CN31	GND	
VSS	CN33	GND	
VSS	CN35	GND	
VSS	CN37	GND	
VSS	CN39	GND	
VSS	CN5	GND	
VSS	CN53	GND	
VSS	CN55	GND	
VSS	CN57	GND	
VSS	CN7	GND	
VSS	CN9	GND	



Table 8-1. Land Name (Sheet 43 of 49)

Land Name	Land No.	Buffer Type	Direction
VSS	CP12	GND	
VSS	CP16	GND	
VSS	CP36	GND	
VSS	CP40	GND	
VSS	CP42	GND	
VSS	CP44	GND	
VSS	CP46	GND	
VSS	CP48	GND	
VSS	CP50	GND	
VSS	CP52	GND	
VSS	CP56	GND	
VSS	CR11	GND	
VSS	CR35	GND	
VSS	CR47	GND	
VSS	CR49	GND	
VSS	CR5	GND	
VSS	CR9	GND	
VSS	CT28	GND	
VSS	CT42	GND	
VSS	CU1	GND	
VSS	CU11	GND	
VSS	CU3	GND	
VSS	CU35	GND	
VSS	CU5	GND	
VSS	CV14	GND	
VSS	CV18	GND	
VSS	CV30	GND	
VSS	CV32	GND	
VSS	CV34	GND	
VSS	CV38	GND	
VSS	CV42	GND	
VSS	CV54	GND	
VSS	CV58	GND	
VSS	CV6	GND	
VSS	CW11	GND	
VSS	CW13	GND	
VSS	CW15	GND	
VSS	CW29	GND	
VSS	CW31	GND	
VSS	CW33	GND	
VSS	CW35	GND	
VSS	CW37	GND	

Table 8-1. Land Name (Sheet 44 of 49)

Land Name	Land No.	Buffer Type	Direction
VSS	CW39	GND	
VSS	CW5	GND	
VSS	CW51	GND	
VSS	CW53	GND	
VSS	CW55	GND	
VSS	CW57	GND	
VSS	CW7	GND	
VSS	CY10	GND	
VSS	CY12	GND	
VSS	CY16	GND	
VSS	CY2	GND	
VSS	CY36	GND	
VSS	CY40	GND	
VSS	CY44	GND	
VSS	CY50	GND	
VSS	CY8	GND	
VSS	D2	GND	
VSS	D26	GND	
VSS	D36	GND	
VSS	D8	GND	
VSS	DA11	GND	
VSS	DA3	GND	
VSS	DA41	GND	
VSS	DA43	GND	
VSS	DA45	GND	
VSS	DA47	GND	
VSS	DA5	GND	
VSS	DA51	GND	
VSS	DA9	GND	
VSS	DB12	GND	
VSS	DB2	GND	
VSS	DB32	GND	
VSS	DB36	GND	
VSS	DB58	GND	
VSS	DC3	GND	
VSS	DC41	GND	
VSS	DC5	GND	
VSS	DD10	GND	
VSS	DD12	GND	
VSS	DD14	GND	
VSS	DD34	GND	
VSS	DD36	GND	



Table 8-1. Land Name (Sheet 45 of 49)

Land Name	Land No.	Buffer Type	Direction
VSS	DD38	GND	
VSS	DD6	GND	
VSS	DE17	GND	
VSS	DE41	GND	
VSS	DE53	GND	
VSS	DE7	GND	
VSS	DF12	GND	
VSS	DF36	GND	
VSS	DF42	GND	
VSS	DF44	GND	
VSS	DF46	GND	
VSS	DF48	GND	
VSS	DF50	GND	
VSS	DF52	GND	
VSS	DF8	GND	
VSS	E1	GND	
VSS	E29	GND	
VSS	E3	GND	
VSS	E31	GND	
VSS	E41	GND	
VSS	E5	GND	
VSS	F36	GND	
VSS	F42	GND	
VSS	F44	GND	
VSS	F48	GND	
VSS	F50	GND	
VSS	F8	GND	
VSS	G1	GND	
VSS	G25	GND	
VSS	G31	GND	
VSS	G35	GND	
VSS	G37	GND	
VSS	G41	GND	
VSS	G45	GND	
VSS	G47	GND	
VSS	G5	GND	
VSS	G51	GND	
VSS	G53	GND	
VSS	G57	GND	
VSS	G9	GND	
VSS	H10	GND	
VSS	H12	GND	

Table 8-1. Land Name (Sheet 46 of 49)

Land Name	Land No.	Buffer Type	Direction
VSS	H14	GND	
VSS	H32	GND	
VSS	H34	GND	
VSS	H38	GND	
VSS	H40	GND	
VSS	H52	GND	
VSS	H54	GND	
VSS	H8	GND	
VSS	J11	GND	
VSS	J27	GND	
VSS	J31	GND	
VSS	J33	GND	
VSS	J39	GND	
VSS	J41	GND	
VSS	J5	GND	
VSS	J55	GND	
VSS	K2	GND	
VSS	K26	GND	
VSS	K28	GND	
VSS	K30	GND	
VSS	K34	GND	
VSS	K8	GND	
VSS	L25	GND	
VSS	L29	GND	
VSS	L41	GND	
VSS	L5	GND	
VSS	M34	GND	
VSS	M36	GND	
VSS	M42	GND	
VSS	M44	GND	
VSS	M46	GND	
VSS	M50	GND	
VSS	M52	GND	
VSS	M8	GND	
VSS	N13	GND	
VSS	N33	GND	
VSS	N35	GND	
VSS	N37	GND	
VSS	N41	GND	
VSS	N43	GND	
VSS	N47	GND	
VSS	N49	GND	



Table 8-1. Land Name (Sheet 47 of 49)

Land Name	Land No.	Buffer Type	Direction
VSS	N5	GND	
VSS	N53	GND	
VSS	N9	GND	
VSS	P10	GND	
VSS	P12	GND	
VSS	P14	GND	
VSS	P26	GND	
VSS	P30	GND	
VSS	P32	GND	
VSS	P38	GND	
VSS	P40	GND	
VSS	P54	GND	
VSS	P56	GND	
VSS	P8	GND	
VSS	R11	GND	
VSS	R29	GND	
VSS	R3	GND	
VSS	R31	GND	
VSS	R35	GND	
VSS	R39	GND	
VSS	R5	GND	
VSS	R55	GND	
VSS	R7	GND	
VSS	T28	GND	
VSS	T4	GND	
VSS	T42	GND	
VSS	T6	GND	
VSS	T8	GND	
VSS	U35	GND	
VSS	U5	GND	
VSS	V26	GND	
VSS	V28	GND	
VSS	V34	GND	
VSS	V36	GND	
VSS	V42	GND	
VSS	V44	GND	
VSS	V46	GND	
VSS	V48	GND	
VSS	V50	GND	
VSS	V8	GND	
VSS	W13	GND	
VSS	W33	GND	

Table 8-1. Land Name (Sheet 48 of 49)

Land Name	Land No.	Buffer Type	Direction
VSS	W37	GND	
VSS	W41	GND	
VSS	W43	GND	
VSS	W45	GND	
VSS	W47	GND	
VSS	W5	GND	
VSS	W51	GND	
VSS	W53	GND	
VSS	W9	GND	
VSS	Y10	GND	
VSS	Y12	GND	
VSS	Y28	GND	
VSS	Y30	GND	
VSS	Y32	GND	
VSS	Y36	GND	
VSS	Y38	GND	
VSS	Y40	GND	
VSS	Y42	GND	
VSS	Y56	GND	
VSS_VCC_SENSE	BY2		O
VSS_VSA_SENSE	AF14		O
VSS_VTTD_SENSE	BT42		O
VTTA	AE45	PWR	
VTTA	AE53	PWR	
VTTA	AM48	PWR	
VTTA	AM54	PWR	
VTTA	AU53	PWR	
VTTA	CA53	PWR	
VTTA	CC45	PWR	
VTTA	CG55	PWR	
VTTA	CJ49	PWR	
VTTA	CR45	PWR	
VTTA	CR51	PWR	
VTTA	DA49	PWR	
VTTA	W49	PWR	
VTTA	Y54	PWR	
VTTD	AF22	PWR	
VTTD	AF24	PWR	
VTTD	AG21	PWR	
VTTD	AG23	PWR	
VTTD	AM42	PWR	
VTTD	AT42	PWR	

**Table 8-1. Land Name (Sheet 49 of 49)**

Land Name	Land No.	Buffer Type	Direction
VTTD	AY42	PWR	
VTTD	BD42	PWR	
VTTD	BH42	PWR	
VTTD	BK56	PWR	
VTTD	BL51	PWR	
VTTD	BM42	PWR	
VTTD	BR55	PWR	
VTTD	BU47	PWR	
VTTD	BV42	PWR	
VTTD	BY20	PWR	
VTTD	BY22	PWR	
VTTD	CA21	PWR	
VTTD	CA23	PWR	
VTTD_SENSE	BP42		O



8.2 Listing by Land Number

Table 8-2. Land Number (Sheet 1 of 48)

Land No.	Land Name	Buffer Type	Direction
A11	DDR3_DQ[33]	SSTL	I/O
A13	DDR3_MA[13]	SSTL	O
A15	DDR3_WE_N	SSTL	O
A17	DDR3_BA[0]	SSTL	O
A19	DDR3_MA[00]	SSTL	O
A21	DDR3_MA[05]	SSTL	O
A23	DDR3_MA[11]	SSTL	O
A33	DDR3_DQ[22]	SSTL	I/O
A35	DDR3_DQ[16]	SSTL	I/O
A37	DDR3_DQ[07]	SSTL	I/O
A39	DDR3_DQ[01]	SSTL	I/O
A41	VSS	GND	
A43	VSS	GND	
A45	VSS	GND	
A47	VSS	GND	
A49	VSS	GND	
A5	VSS	GND	
A51	VSS	GND	
A53	RSVD		
A7	VSS	GND	
A9	DDR3_DQ[39]	SSTL	I/O
AA11	VSS	GND	
AA13	DDR2_DQ[37]	SSTL	I/O
AA15	DDR2_CS_N[3]	SSTL	O
AA17	DDR2_CS_N[9]	SSTL	O
AA19	DDR2_CS_N[4]	SSTL	O
AA21	DDR2_CLK_DP[2]	SSTL	O
AA23	DDR2_CLK_DP[3]	SSTL	O
AA25	DDR2_CKE[0]	SSTL	O
AA27	DDR2_ECC[7]	SSTL	I/O
AA29	VSS	GND	
AA3	VSS	GND	
AA31	VSS	GND	
AA33	DDR2_DQS_DN[03]	SSTL	I/O
AA35	DDR2_DQ[28]	SSTL	I/O
AA37	DDR2_DQ[10]	SSTL	I/O
AA39	VSS	GND	
AA41	DDR2_DQ[13]	SSTL	I/O
AA43	PE3D_TX_DN[14]	PCIEX3	O
AA45	PE3D_TX_DP[12]	PCIEX3	O

Table 8-2. Land Number (Sheet 2 of 48)

Land No.	Land Name	Buffer Type	Direction
AA47	PE3C_TX_DP[9]	PCIEX3	O
AA49	PE3A_RX_DP[3]	PCIEX3	I
AA5	VSS	GND	
AA51	PE3B_RX_DP[7]	PCIEX3	I
AA53	PE3B_RX_DP[6]	PCIEX3	I
AA55	VSS	GND	
AA7	DDR2_DQS_DN[14]	SSTL	I/O
AA9	VSS	GND	
AB10	DDR2_DQ[38]	SSTL	I/O
AB12	DDR2_DQS_DP[13]	SSTL	I/O
AB14	VSS	GND	
AB16	DDR2_CS_N[6]	SSTL	O
AB18	DDR2_MA[00]	SSTL	O
AB20	DDR2_CS_N[0]	SSTL	O
AB22	DDR2_CLK_DP[1]	SSTL	O
AB24	DDR2_CLK_DP[0]	SSTL	O
AB26	DDR2_ECC[3]	SSTL	I/O
AB28	DDR2_DQS_DN[08]	SSTL	I/O
AB30	DDR2_ECC[4]	SSTL	I/O
AB32	DDR2_DQ[30]	SSTL	I/O
AB34	DDR2_DQS_DN[12]	SSTL	I/O
AB36	VSS	GND	
AB38	DDR2_DQS_DP[01]	SSTL	I/O
AB4	DDR2_DQS_DP[07]	SSTL	I/O
AB40	DDR2_DQS_DP[10]	SSTL	I/O
AB42	VSS	GND	
AB44	PE3D_TX_DN[13]	PCIEX3	O
AB46	PE3C_TX_DN[11]	PCIEX3	O
AB48	RSVD		
AB50	PE3B_RX_DN[4]	PCIEX3	I
AB52	PE3B_RX_DN[5]	PCIEX3	I
AB54	PE2B_RX_DP[4]	PCIEX3	I
AB56	PE2B_RX_DP[5]	PCIEX3	I
AB6	VSS	GND	
AB8	DDR2_DQS_DN[05]	SSTL	I/O
AC11	DDR2_DQS_DN[04]	SSTL	I/O
AC13	DDR2_DQ[32]	SSTL	I/O
AC15	DDR23_RCOMP[1]	Analog	I
AC17	VCCD_23	PWR	
AC19	VCCD_23	PWR	



Table 8-2. Land Number (Sheet 3 of 48)

Land No.	Land Name	Buffer Type	Direction
AC21	VCCD_23	PWR	
AC23	VCCD_23	PWR	
AC25	VCCD_23	PWR	
AC27	DDR2_DQS_DP[08]	SSTL	I/O
AC29	DDR2_DQS_DP[17]	SSTL	I/O
AC3	DDR2_DQS_DN[07]	SSTL	I/O
AC31	VSS	GND	
AC33	DDR2_DQS_DP[03]	SSTL	I/O
AC35	DDR2_DQ[24]	SSTL	I/O
AC37	DDR2_DQ[11]	SSTL	I/O
AC39	DDR2_DQS_DN[10]	SSTL	I/O
AC41	DDR2_DQ[12]	SSTL	I/O
AC43	PE3D_TX_DP[14]	PCIEX3	O
AC45	PE3D_TX_DN[12]	PCIEX3	O
AC47	PE3C_TX_DN[9]	PCIEX3	O
AC49	PE3A_RX_DN[3]	PCIEX3	I
AC5	DDR2_DQS_DP[16]	SSTL	I/O
AC51	PE3B_RX_DN[7]	PCIEX3	I
AC53	PE3B_RX_DN[6]	PCIEX3	I
AC55	PE2B_RX_DP[6]	PCIEX3	I
AC7	DDR2_DQS_DP[05]	SSTL	I/O
AC9	VSS	GND	
AD10	DDR2_DQ[39]	SSTL	I/O
AD12	DDR2_DQS_DN[13]	SSTL	I/O
AD14	DDR2_DQ[36]	SSTL	I/O
AD16	DDR2_CS_N[2]	SSTL	O
AD18	DDR2_ODT[2]	SSTL	O
AD20	DDR2_PAR_ERR_N	SSTL	I
AD22	DDR2_ODT[4]	SSTL	O
AD24	DDR2_CKE[3]	SSTL	O
AD26	VSS	GND	
AD28	DDR2_DQS_DN[17]	SSTL	I/O
AD30	DDR2_ECC[5]	SSTL	I/O
AD32	DDR2_DQ[31]	SSTL	I/O
AD34	VSS	GND	
AD36	VSS	GND	
AD38	DDR2_DQS_DN[01]	SSTL	I/O
AD4	DDR2_DQS_DN[16]	SSTL	I/O
AD40	DDR2_DQ[09]	SSTL	I/O
AD42	VSS	GND	
AD44	VSS	GND	
AD46	VSS	GND	

Table 8-2. Land Number (Sheet 4 of 48)

Land No.	Land Name	Buffer Type	Direction
AD48	VSS	GND	
AD50	VSS	GND	
AD52	VSS	GND	
AD54	PE2B_RX_DN[4]	PCIEX3	I
AD56	PE2B_RX_DN[5]	PCIEX3	I
AD6	VSS	GND	
AD8	DDR2_DQ[46]	SSTL	I/O
AE11	DDR2_DQS_DP[04]	SSTL	I/O
AE13	DDR2_DQ[33]	SSTL	I/O
AE15	VSA	PWR	
AE17	VSA	PWR	
AE19	DDR2_CS_N[1]	SSTL	O
AE21	DDR2_ODT[5]	SSTL	O
AE23	DDR2_CKE[5]	SSTL	O
AE25	DDR2_CKE[4]	SSTL	O
AE27	DDR_RESET_C23_N	CMOS1.5v	O
AE29	VSS	GND	
AE3	DDR2_DQ[63]	SSTL	I/O
AE31	VSS	GND	
AE33	DDR2_DQ[26]	SSTL	I/O
AE35	DDR2_DQ[25]	SSTL	I/O
AE37	DDR2_DQ[15]	SSTL	I/O
AE39	VSS	GND	
AE41	DDR2_DQ[08]	SSTL	I/O
AE43	VSS	GND	
AE45	VTTA	PWR	
AE47	VSS	GND	
AE49	VSS	GND	
AE5	DDR2_DQ[59]	SSTL	I/O
AE51	VSS	GND	
AE53	VTTA	PWR	
AE55	PE2B_RX_DN[6]	PCIEX3	I
AE57	PE2B_RX_DP[7]	PCIEX3	I
AE7	DDR2_DQ[47]	SSTL	I/O
AE9	VSS	GND	
AF10	DDR2_DQ[35]	SSTL	I/O
AF12	VSS	GND	
AF14	VSS_VSA_SENSE		O
AF16	VSS	GND	
AF18	VSA	PWR	
AF2	DDR2_DQ[62]	SSTL	I/O
AF20	VSS	GND	



Table 8-2. Land Number (Sheet 5 of 48)

Land No.	Land Name	Buffer Type	Direction
AF22	VTTD	PWR	
AF24	VTTD	PWR	
AF26	VSS	GND	
AF28	DDR2_ECC[1]	SSTL	I/O
AF30	DDR2_ECC[0]	SSTL	I/O
AF32	DDR2_DQ[27]	SSTL	I/O
AF34	VSS	GND	
AF36	VSS	GND	
AF38	DDR2_DQ[14]	SSTL	I/O
AF4	DDR2_DQ[58]	SSTL	I/O
AF40	VSS	GND	
AF42	VSS	GND	
AF44	PE3A_RX_DP[0]	PCIEX3	I
AF46	PE3A_RX_DP[2]	PCIEX3	I
AF48	PE3C_RX_DP[8]	PCIEX3	I
AF50	PE3C_RX_DP[10]	PCIEX3	I
AF52	PE_RBIAS_SENSE	PCIEX3	I
AF54	VSS	GND	
AF56	VSS	GND	
AF58	PE2B_RX_DN[7]	PCIEX3	I
AF6	VSS	GND	
AF8	DDR2_DQ[42]	SSTL	I/O
AG1	VSS	GND	
AG11	DDR2_DQ[34]	SSTL	I/O
AG13	VSA_SENSE		O
AG15	VSA	PWR	
AG17	VSA	PWR	
AG19	VCC	PWR	
AG21	VTTD	PWR	
AG23	VTTD	PWR	
AG25	VCC	PWR	
AG27	VCC	PWR	
AG29	VCC	PWR	
AG3	VSS	GND	
AG31	VCC	PWR	
AG33	VCC	PWR	
AG35	VCC	PWR	
AG37	VCC	PWR	
AG39	VCC	PWR	
AG41	VCC	PWR	
AG43	VSS	GND	
AG45	PE3A_RX_DP[1]	PCIEX3	I

Table 8-2. Land Number (Sheet 6 of 48)

Land No.	Land Name	Buffer Type	Direction
AG47	PE3D_RX_DP[12]	PCIEX3	I
AG49	PE3C_RX_DP[11]	PCIEX3	I
AG5	VSS	GND	
AG51	PE3C_RX_DP[9]	PCIEX3	I
AG53	PE2B_TX_DP[4]	PCIEX3	O
AG55	VSS	GND	
AG57	VSS	GND	
AG7	DDR2_DQ[43]	SSTL	I/O
AG9	VSS	GND	
AH10	VSA	PWR	
AH12	VSA	PWR	
AH14	VSA	PWR	
AH16	VSA	PWR	
AH2	VSA	PWR	
AH4	VSA	PWR	
AH42	IVT_ID_N		O
AH44	PE3A_RX_DN[0]	PCIEX3	I
AH46	PE3A_RX_DN[2]	PCIEX3	I
AH48	PE3C_RX_DN[8]	PCIEX3	I
AH50	PE3C_RX_DN[10]	PCIEX3	I
AH52	PE_RBIAS	PCIEX3	I/O
AH54	PE2B_TX_DP[5]	PCIEX3	O
AH56	PE2C_RX_DP[8]	PCIEX3	I
AH58	VSS	GND	
AH6	VSA	PWR	
AH8	VSA	PWR	
AJ1	VSA	PWR	
AJ11	VSA	PWR	
AJ13	VSA	PWR	
AJ15	VSS	GND	
AJ17	VSS	GND	
AJ3	VSA	PWR	
AJ43	PE_VREF_CAP	PCIEX3	I/O
AJ45	PE3A_RX_DN[1]	PCIEX3	I
AJ47	PE3D_RX_DN[12]	PCIEX3	I
AJ49	PE3C_RX_DN[11]	PCIEX3	I
AJ5	VSA	PWR	
AJ51	PE3C_RX_DN[9]	PCIEX3	I
AJ53	PE2B_TX_DN[4]	PCIEX3	O
AJ55	RSVD		
AJ57	PE2C_RX_DP[10]	PCIEX3	I
AJ7	VSA	PWR	



Table 8-2. Land Number (Sheet 7 of 48)

Land No.	Land Name	Buffer Type	Direction
AJ9	VSA	PWR	
AK10	VSS	GND	
AK12	VSS	GND	
AK14	VSS	GND	
AK16	VSS	GND	
AK2	VSS	GND	
AK4	VSS	GND	
AK42	VSS	GND	
AK44	VSS	GND	
AK46	VSS	GND	
AK48	VSS	GND	
AK50	VSS	GND	
AK52	TXT_AGENT	CMOS	I
AK54	PE2B_TX_DN[5]	PCIEX3	O
AK56	PE2C_RX_DN[8]	PCIEX3	I
AK58	PE2C_RX_DP[9]	PCIEX3	I
AK6	VSS	GND	
AK8	VSS	GND	
AL1	VCC	PWR	
AL11	VCC	PWR	
AL13	VCC	PWR	
AL15	VCC	PWR	
AL17	VCC	PWR	
AL3	VCC	PWR	
AL43	VSS	GND	
AL45	VSS	GND	
AL47	BMCINIT	CMOS	I
AL49	VSS	GND	
AL5	VCC	PWR	
AL51	VSS	GND	
AL53	VSS	GND	
AL55	RSVD		
AL57	PE2C_RX_DN[10]	PCIEX3	I
AL7	VCC	PWR	
AL9	VCC	PWR	
AM10	VCC	PWR	
AM12	VCC	PWR	
AM14	VCC	PWR	
AM16	VCC	PWR	
AM2	VCC	PWR	
AM4	VCC	PWR	
AM42	VTTD	PWR	

Table 8-2. Land Number (Sheet 8 of 48)

Land No.	Land Name	Buffer Type	Direction
AM44	RSVD		
AM46	PE3D_RX_DP[14]	PCIEX3	I
AM48	VTTA	PWR	
AM50	PE2A_TX_DP[1]	PCIEX3	O
AM52	PE2A_TX_DP[3]	PCIEX3	O
AM54	VTTA	PWR	
AM56	VSS	GND	
AM58	PE2C_RX_DN[9]	PCIEX3	I
AM6	VCC	PWR	
AM8	VCC	PWR	
AN1	VCC	PWR	
AN11	VCC	PWR	
AN13	VCC	PWR	
AN15	VCC	PWR	
AN17	VCC	PWR	
AN3	VCC	PWR	
AN43	CPU_ONLY_RESET	ODCMOS	I/O
AN45	PE3D_RX_DP[15]	PCIEX3	I
AN47	PE3D_RX_DP[13]	PCIEX3	I
AN49	PE2A_TX_DP[0]	PCIEX3	O
AN5	VCC	PWR	
AN51	PE2A_TX_DP[2]	PCIEX3	O
AN53	PE2B_TX_DP[6]	PCIEX3	O
AN55	VSS	GND	
AN57	VSS	GND	
AN7	VCC	PWR	
AN9	VCC	PWR	
AP10	VCC	PWR	
AP12	VCC	PWR	
AP14	VCC	PWR	
AP16	VCC	PWR	
AP2	VCC	PWR	
AP4	VCC	PWR	
AP42	VSS	GND	
AP44	VSS	GND	
AP46	PE3D_RX_DN[14]	PCIEX3	I
AP48	RSVD		
AP50	PE2A_TX_DN[1]	PCIEX3	O
AP52	PE2A_TX_DN[3]	PCIEX3	O
AP54	PE2B_TX_DP[7]	PCIEX3	O
AP56	PE2D_RX_DP[13]	PCIEX3	I
AP58	VSS	GND	



Table 8-2. Land Number (Sheet 9 of 48)

Land No.	Land Name	Buffer Type	Direction
AP6	VCC	PWR	
AP8	VCC	PWR	
AR1	VSS	GND	
AR11	VSS	GND	
AR13	VSS	GND	
AR15	VSS	GND	
AR17	VSS	GND	
AR3	VSS	GND	
AR43	BPM_N[0]	ODCMOS	I/O
AR45	PE3D_RX_DN[15]	PCIEX3	I
AR47	PE3D_RX_DN[13]	PCIEX3	I
AR49	PE2A_TX_DN[0]	PCIEX3	O
AR5	VSS	GND	
AR51	PE2A_TX_DN[2]	PCIEX3	O
AR53	PE2B_TX_DN[6]	PCIEX3	O
AR55	RSVD		
AR57	PE2C_RX_DP[11]	PCIEX3	I
AR7	VSS	GND	
AR9	VSS	GND	
AT10	VSS	GND	
AT12	VSS	GND	
AT14	VSS	GND	
AT16	VSS	GND	
AT2	VSS	GND	
AT4	VSS	GND	
AT42	VTTD	PWR	
AT44	BPM_N[1]	ODCMOS	I/O
AT46	VSS	GND	
AT48	BIST_ENABLE	CMOS	I
AT50	FRMAGENT	CMOS	I
AT52	VSS	GND	
AT54	PE2B_TX_DN[7]	PCIEX3	O
AT56	PE2D_RX_DN[13]	PCIEX3	I
AT58	PE2D_RX_DP[12]	PCIEX3	I
AT6	VSS	GND	
AT8	VSS	GND	
AU1	VCC	PWR	
AU11	VCC	PWR	
AU13	VCC	PWR	
AU15	VCC	PWR	
AU17	VCC	PWR	
AU3	VCC	PWR	

Table 8-2. Land Number (Sheet 10 of 48)

Land No.	Land Name	Buffer Type	Direction
AU43	BPM_N[2]	ODCMOS	I/O
AU45	VSS	GND	
AU47	VSS	GND	
AU49	VSS	GND	
AU5	VCC	PWR	
AU51	VSS	GND	
AU53	VTTA	PWR	
AU55	RSVD		
AU57	PE2C_RX_DN[11]	PCIEX3	I
AU7	VCC	PWR	
AU9	VCC	PWR	
AV10	VCC	PWR	
AV12	VCC	PWR	
AV14	VCC	PWR	
AV16	VCC	PWR	
AV2	VCC	PWR	
AV4	VCC	PWR	
AV42	VSS	GND	
AV44	BPM_N[3]	ODCMOS	I/O
AV46	RSVD		
AV48	PE2D_TX_DP[14]	PCIEX3	O
AV50	PE2D_TX_DP[12]	PCIEX3	O
AV52	PE2C_TX_DP[8]	PCIEX3	O
AV54	VSS	GND	
AV56	VSS	GND	
AV58	PE2D_RX_DN[12]	PCIEX3	I
AV6	VCC	PWR	
AV8	VCC	PWR	
AW1	VCC	PWR	
AW11	VCC	PWR	
AW13	VCC	PWR	
AW15	VCC	PWR	
AW17	VCC	PWR	
AW3	VCC	PWR	
AW43	BPM_N[5]	ODCMOS	I/O
AW45	BCLK1_DP	CMOS	I
AW47	PE2D_TX_DP[15]	PCIEX3	O
AW49	PE2D_TX_DP[13]	PCIEX3	O
AW5	VCC	PWR	
AW51	PE2C_TX_DP[11]	PCIEX3	O
AW53	PE2C_TX_DP[9]	PCIEX3	O
AW55	VSS	GND	



Table 8-2. Land Number (Sheet 11 of 48)

Land No.	Land Name	Buffer Type	Direction
AW57	VSS	GND	
AW7	VCC	PWR	
AW9	VCC	PWR	
AY10	VCC	PWR	
AY12	VCC	PWR	
AY14	VCC	PWR	
AY16	VCC	PWR	
AY2	VCC	PWR	
AY4	VCC	PWR	
AY42	VTTD	PWR	
AY44	BPM_N[7]	ODCMOS	I/O
AY46	RSVD		
AY48	PE2D_TX_DN[14]	PCIEX3	O
AY50	PE2D_TX_DN[12]	PCIEX3	O
AY52	PE2C_TX_DN[8]	PCIEX3	O
AY54	PE2C_TX_DP[10]	PCIEX3	O
AY56	PE2D_RX_DP[15]	PCIEX3	I
AY58	PE2D_RX_DP[14]	PCIEX3	I
AY6	VCC	PWR	
AY8	VCC	PWR	
B10	DDR3_DQS_DN[04]	SSTL	I/O
B12	DDR3_DQ[37]	SSTL	I/O
B14	DDR3_CAS_N	SSTL	O
B16	DDR3_RAS_N	SSTL	O
B18	DDR3_MA_PAR	SSTL	O
B20	DDR3_MA[03]	SSTL	O
B22	DDR3_MA[07]	SSTL	O
B24	DDR3_BA[2]	SSTL	O
B32	DDR3_DQ[23]	SSTL	I/O
B34	DDR3_DQS_DN[11]	SSTL	I/O
B36	VSS	GND	
B38	DDR3_DQS_DN[00]	SSTL	I/O
B40	DDR3_DQ[00]	SSTL	I/O
B42	DMI_TX_DP[0]	PCIEX	O
B44	DMI_TX_DP[2]	PCIEX	O
B46	RSVD		
B48	DMI_RX_DP[1]	PCIEX	I
B50	DMI_RX_DP[3]	PCIEX	I
B52	VSS	GND	
B54	VSA	PWR	
B6	VSS	GND	
B8	VSS	GND	

Table 8-2. Land Number (Sheet 12 of 48)

Land No.	Land Name	Buffer Type	Direction
BA1	VCC	PWR	
BA11	VCC	PWR	
BA13	VCC	PWR	
BA15	VCC	PWR	
BA17	VCC	PWR	
BA3	VCC	PWR	
BA43	BPM_N[6]	ODCMOS	I/O
BA45	BCLK1_DN	CMOS	I
BA47	PE2D_TX_DN[15]	PCIEX3	O
BA49	PE2D_TX_DN[13]	PCIEX3	O
BA5	VCC	PWR	
BA51	PE2C_TX_DN[11]	PCIEX3	O
BA53	PE2C_TX_DN[9]	PCIEX3	O
BA55	TEST4		I
BA57	PE2D_RX_DN[14]	PCIEX3	I
BA7	VCC	PWR	
BA9	VCC	PWR	
BB10	VCC	PWR	
BB12	VCC	PWR	
BB14	VCC	PWR	
BB16	VCC	PWR	
BB2	VCC	PWR	
BB4	VCC	PWR	
BB42	VSS	GND	
BB44	BPM_N[4]	ODCMOS	I/O
BB46	VSS	GND	
BB48	VSS	GND	
BB50	VSS	GND	
BB52	VSS	GND	
BB54	PE2C_TX_DN[10]	PCIEX3	O
BB56	PE2D_RX_DN[15]	PCIEX3	I
BB58	VSS	GND	
BB6	VCC	PWR	
BB8	VCC	PWR	
BC1	VSS	GND	
BC11	VSS	GND	
BC13	VSS	GND	
BC15	VSS	GND	
BC17	VSS	GND	
BC3	VSS	GND	
BC43	VSS	GND	
BC45	VSS	GND	



Table 8-2. Land Number (Sheet 13 of 48)

Land No.	Land Name	Buffer Type	Direction
BC47	RSVD		
BC49	SOCKET_ID[1]	CMOS	I
BC5	VSS	GND	
BC51	ERROR_N[2]	ODCMOS	O
BC53	VSS	GND	
BC55	VSS	GND	
BC57	VSS	GND	
BC7	VSS	GND	
BC9	VSS	GND	
BD10	VSS	GND	
BD12	VSS	GND	
BD14	VSS	GND	
BD16	VSS	GND	
BD2	VSS	GND	
BD4	VSS	GND	
BD42	VTTD	PWR	
BD44	RSVD		
BD46	RSVD		
BD48	RSVD		
BD50	ERROR_N[0]	ODCMOS	O
BD52	PROCHOT_N	ODCMOS	I/O
BD54	VSS	GND	
BD56	VSS	GND	
BD58	QPIO_DRX_DP[07]	QPI	I
BD6	VSS	GND	
BD8	VSS	GND	
BE1	VCC	PWR	
BE11	VCC	PWR	
BE13	VCC	PWR	
BE15	VCC	PWR	
BE17	VCC	PWR	
BE3	VCC	PWR	
BE43	RSVD		
BE45	RSVD		
BE47	RSVD		
BE49	VSS	GND	
BE5	VCC	PWR	
BE51	VSS	GND	
BE53	QPIO_DRX_DP[02]	QPI	I
BE55	QPIO_DRX_DP[03]	QPI	I
BE57	QPIO_DRX_DP[08]	QPI	I
BE7	VCC	PWR	

Table 8-2. Land Number (Sheet 14 of 48)

Land No.	Land Name	Buffer Type	Direction
BE9	VCC	PWR	
BF10	VCC	PWR	
BF12	VCC	PWR	
BF14	VCC	PWR	
BF16	VCC	PWR	
BF2	VCC	PWR	
BF4	VCC	PWR	
BF42	VSS	GND	
BF44	VSS	GND	
BF46	RSVD		
BF48	PEHPSDA	ODCMOS	I/O
BF50	QPIO_DRX_DP[06]	QPI	I
BF52	QPIO_DRX_DP[01]	QPI	I
BF54	QPIO_DRX_DP[05]	QPI	I
BF56	QPIO_DRX_DP[04]	QPI	I
BF58	QPIO_DRX_DN[07]	QPI	I
BF6	VCC	PWR	
BF8	VCC	PWR	
BG1	VCC	PWR	
BG11	VCC	PWR	
BG13	VCC	PWR	
BG15	VCC	PWR	
BG17	VCC	PWR	
BG3	VCC	PWR	
BG43	RSVD		
BG45	RSVD		
BG47	VSS	GND	
BG49	QPIO_DRX_DP[17]	QPI	I
BG5	VCC	PWR	
BG51	QPIO_DRX_DP[00]	QPI	I
BG53	QPIO_DRX_DN[02]	QPI	I
BG55	QPIO_DRX_DN[03]	QPI	I
BG57	QPIO_DRX_DN[08]	QPI	I
BG7	VCC	PWR	
BG9	VCC	PWR	
BH10	VCC	PWR	
BH12	VCC	PWR	
BH14	VCC	PWR	
BH16	VCC	PWR	
BH2	VCC	PWR	
BH4	VCC	PWR	
BH42	VTTD	PWR	



Table 8-2. Land Number (Sheet 15 of 48)

Land No.	Land Name	Buffer Type	Direction
BH44	RSVD		
BH46	RSVD		
BH48	PEHPSCCL	ODCMOS	I/O
BH50	QPI0_DRX_DN[06]	QPI	I
BH52	QPI0_DRX_DN[01]	QPI	I
BH54	QPI0_DRX_DN[05]	QPI	I
BH56	QPI0_DRX_DN[04]	QPI	I
BH58	VSS	GND	
BH6	VCC	PWR	
BH8	VCC	PWR	
BJ1	VCC	PWR	
BJ11	VCC	PWR	
BJ13	VCC	PWR	
BJ15	VCC	PWR	
BJ17	VCC	PWR	
BJ3	VCC	PWR	
BJ43	RSVD		
BJ45	RSVD		
BJ47	PECI	PECI	I/O
BJ49	QPI0_DRX_DN[17]	QPI	I
BJ5	VCC	PWR	
BJ51	QPI0_DRX_DN[00]	QPI	I
BJ53	PWRGOOD	CMOS	I
BJ55	VSS	GND	
BJ57	VSS	GND	
BJ7	VCC	PWR	
BJ9	VCC	PWR	
BK10	VCC	PWR	
BK12	VCC	PWR	
BK14	VCC	PWR	
BK16	VCC	PWR	
BK2	VCC	PWR	
BK4	VCC	PWR	
BK42	VSS	GND	
BK44	RSVD		
BK46	VSS	GND	
BK48	VSS	GND	
BK50	VSS	GND	
BK52	VSS	GND	
BK54	VSS	GND	
BK56	VTTD	PWR	
BK58	QPI0_CLKRX_DP	QPI	I

Table 8-2. Land Number (Sheet 16 of 48)

Land No.	Land Name	Buffer Type	Direction
BK6	VCC	PWR	
BK8	VCC	PWR	
BL1	VSS	GND	
BL11	VSS	GND	
BL13	VSS	GND	
BL15	VSS	GND	
BL17	VSS	GND	
BL3	VSS	GND	
BL43	RSVD		
BL45	RSVD		
BL47	THERMTRIP_N	ODCMOS	O
BL49	VSS	GND	
BL5	VSS	GND	
BL51	VTTD	PWR	
BL53	QPI0_DRX_DP[13]	QPI	I
BL55	QPI0_DRX_DP[11]	QPI	I
BL57	QPI0_DRX_DP[09]	QPI	I
BL7	VSS	GND	
BL9	VSS	GND	
BM10	VSS	GND	
BM12	VSS	GND	
BM14	VSS	GND	
BM16	VSS	GND	
BM2	VSS	GND	
BM4	VSS	GND	
BM42	VTTD	PWR	
BM44	RSVD		
BM46	RSVD		
BM48	QPI0_DRX_DN[19]	QPI	I
BM50	QPI0_DRX_DP[16]	QPI	I
BM52	QPI0_DRX_DP[14]	QPI	I
BM54	QPI0_DRX_DP[12]	QPI	I
BM56	QPI0_DRX_DP[10]	QPI	I
BM58	QPI0_CLKRX_DN	QPI	I
BM6	VSS	GND	
BM8	VSS	GND	
BN1	VCC	PWR	
BN11	VCC	PWR	
BN13	VCC	PWR	
BN15	VCC	PWR	
BN17	VCC	PWR	
BN3	VCC	PWR	



Table 8-2. Land Number (Sheet 17 of 48)

Land No.	Land Name	Buffer Type	Direction
BN43	VSS	GND	
BN45	VSS	GND	
BN47	RSVD		
BN49	QPIO_DRX_DN[18]	QPI	I
BN5	VCC	PWR	
BN51	QPIO_DRX_DP[15]	QPI	I
BN53	QPIO_DRX_DN[13]	QPI	I
BN55	QPIO_DRX_DN[11]	QPI	I
BN57	QPIO_DRX_DN[09]	QPI	I
BN7	VCC	PWR	
BN9	VCC	PWR	
BP10	VCC	PWR	
BP12	VCC	PWR	
BP14	VCC	PWR	
BP16	VCC	PWR	
BP2	VCC	PWR	
BP4	VCC	PWR	
BP42	VTTD_SENSE		O
BP44	RSVD		
BP46	RSVD		
BP48	QPIO_DRX_DP[19]	QPI	I
BP50	QPIO_DRX_DN[16]	QPI	I
BP52	QPIO_DRX_DN[14]	QPI	I
BP54	QPIO_DRX_DN[12]	QPI	I
BP56	QPIO_DRX_DN[10]	QPI	I
BP58	VSS	GND	
BP6	VCC	PWR	
BP8	VCC	PWR	
BR1	VCC	PWR	
BR11	VCC	PWR	
BR13	VCC	PWR	
BR15	VCC	PWR	
BR17	VCC	PWR	
BR3	VCC	PWR	
BR43	RSVD		
BR45	SVDDATA	ODCMOS	I/O
BR47	RSVD		
BR49	QPIO_DRX_DP[18]	QPI	I
BR5	VCC	PWR	
BR51	QPIO_DRX_DN[15]	QPI	I
BR53	VSS	GND	
BR55	VTTD	PWR	

Table 8-2. Land Number (Sheet 18 of 48)

Land No.	Land Name	Buffer Type	Direction
BR57	VSS	GND	
BR7	VCC	PWR	
BR9	VCC	PWR	
BT10	VCC	PWR	
BT12	VCC	PWR	
BT14	VCC	PWR	
BT16	VCC	PWR	
BT2	VCC	PWR	
BT4	VCC	PWR	
BT42	VSS_VTTD_SENSE		O
BT44	RSVD		
BT46	VSS	GND	
BT48	VSS	GND	
BT50	VSS	GND	
BT52	VSS	GND	
BT54	VSS	GND	
BT56	VSS	GND	
BT58	QPIO_DTX_DP[05]	QPI	O
BT6	VCC	PWR	
BT8	VCC	PWR	
BU1	VCC	PWR	
BU11	VCC	PWR	
BU13	VCC	PWR	
BU15	VCC	PWR	
BU17	VCC	PWR	
BU3	VCC	PWR	
BU43	RSVD		
BU45	VSS	GND	
BU47	VTTD	PWR	
BU49	SKTOCC_N		O
BU5	VCC	PWR	
BU51	VSS	GND	
BU53	QPIO_DTX_DP[02]	QPI	O
BU55	QPIO_DTX_DP[04]	QPI	O
BU57	QPIO_DTX_DP[07]	QPI	O
BU7	VCC	PWR	
BU9	VCC	PWR	
BV10	VCC	PWR	
BV12	VCC	PWR	
BV14	VCC	PWR	
BV16	VCC	PWR	
BV2	VCC	PWR	



Table 8-2. Land Number (Sheet 19 of 48)

Land No.	Land Name	Buffer Type	Direction
BV4	VCC	PWR	
BV42	VTTD	PWR	
BV44	TMS	CMOS	I
BV46	QPI0_DTX_DP[09]	QPI	O
BV48	QPI0_DTX_DP[06]	QPI	O
BV50	QPI0_DTX_DP[00]	QPI	O
BV52	QPI0_DTX_DP[01]	QPI	O
BV54	QPI0_DTX_DP[03]	QPI	O
BV56	QPI0_DTX_DP[08]	QPI	O
BV58	QPI0_DTX_DN[05]	QPI	O
BV6	VCC	PWR	
BV8	VCC	PWR	
BW1	VSS	GND	
BW11	VSS	GND	
BW13	VSS	GND	
BW15	VSS	GND	
BW17	VSS	GND	
BW3	VCC_SENSE		O
BW43	TDI	CMOS	I
BW45	QPI0_DTX_DN[09]	QPI	O
BW47	QPI0_DTX_DN[06]	QPI	O
BW49	QPI0_DTX_DN[00]	QPI	O
BW5	VSS	GND	
BW51	QPI0_DTX_DN[01]	QPI	O
BW53	QPI0_DTX_DN[02]	QPI	O
BW55	QPI0_DTX_DN[04]	QPI	O
BW57	QPI0_DTX_DN[07]	QPI	O
BW7	VSS	GND	
BW9	DDR0_DQ[28]	SSTL	I/O
BY10	DDR0_DQ[24]	SSTL	I/O
BY12	DDR0_DQ[25]	SSTL	I/O
BY14	VCCPLL	PWR	
BY16	DDR_VREFDQRX_C01	DC	I
BY18	VCC	PWR	
BY2	VSS_VCC_SENSE		O
BY20	VTTD	PWR	
BY22	VTTD	PWR	
BY24	VSS	GND	
BY26	VCC	PWR	
BY28	VCC	PWR	
BY30	VCC	PWR	
BY32	VCC	PWR	

Table 8-2. Land Number (Sheet 20 of 48)

Land No.	Land Name	Buffer Type	Direction
BY34	VCC	PWR	
BY36	VCC	PWR	
BY38	VCC	PWR	
BY4	VSS	GND	
BY40	VCC	PWR	
BY42	VSS	GND	
BY44	TCK	CMOS	I
BY46	RSVD		
BY48	QPI0_DTX_DP[12]	QPI	O
BY50	QPI0_DTX_DP[13]	QPI	O
BY52	QPI0_DTX_DN[11]	QPI	O
BY54	QPI0_DTX_DN[03]	QPI	O
BY56	QPI0_DTX_DN[08]	QPI	O
BY58	VSS	GND	
BY6	DDR0_DQ[04]	SSTL	I/O
BY8	VSS	GND	
C11	VSS	GND	
C13	VSS	GND	
C15	VCCD_23	PWR	
C17	VCCD_23	PWR	
C19	VCCD_23	PWR	
C21	VCCD_23	PWR	
C23	VCCD_23	PWR	
C25	DDR3_ECC[3]	SSTL	I/O
C3	VSS	GND	
C33	VSS	GND	
C35	DDR3_DQ[21]	SSTL	I/O
C37	DDR3_DQ[02]	SSTL	I/O
C39	VSS	GND	
C41	VSS	GND	
C43	DMI_TX_DP[1]	PCIEX	O
C45	DMI_TX_DP[3]	PCIEX	O
C47	DMI_RX_DP[0]	PCIEX	I
C49	DMI_RX_DP[2]	PCIEX	I
C5	VSS	GND	
C51	PE1A_RX_DP[0]	PCIEX3	I
C53	RSVD		
C55	VSS	GND	
C7	DDR3_DQ[52]	SSTL	I/O
C9	DDR3_DQ[34]	SSTL	I/O
CA1	DDR0_DQ[12]	SSTL	I/O
CA11	VSS	GND	



Table 8-2. Land Number (Sheet 21 of 48)

Land No.	Land Name	Buffer Type	Direction
CA13	VCCPLL	PWR	
CA15	VCCPLL	PWR	
CA17	DDR01_RCOMP[0]	Analog	I
CA19	VSS	GND	
CA21	VTTD	PWR	
CA23	VTTD	PWR	
CA25	VCC	PWR	
CA27	VSS	GND	
CA29	VCC	PWR	
CA3	DDR0_DQ[13]	SSTL	I/O
CA31	VSS	GND	
CA33	VSS	GND	
CA35	VSS	GND	
CA37	VSS	GND	
CA39	VSS	GND	
CA41	VSS	GND	
CA43	TDO	ODCMOS	O
CA45	RSVD		
CA47	QPIO_DTX_DN[12]	QPI	O
CA49	QPIO_DTX_DN[13]	QPI	O
CA5	VSS	GND	
CA51	QPIO_DTX_DP[11]	QPI	O
CA53	VTTA	PWR	
CA55	VSS	GND	
CA57	VSS	GND	
CA7	DDR0_DQ[05]	SSTL	I/O
CA9	DDR0_DQ[29]	SSTL	I/O
CB10	DDR0_DQS_DP[12]	SSTL	I/O
CB12	DDR0_DQ[26]	SSTL	I/O
CB14	DDR0_ECC[4]	SSTL	I/O
CB16	VSS	GND	
CB18	DDR_RESET_C01_N	CMOS1.5v	O
CB2	DDR0_DQ[08]	SSTL	I/O
CB20	DDR01_RCOMP[2]	Analog	I
CB22	MEM_HOT_C01_N	ODCMOS	I/O
CB24	DDR0_ODT[4]	SSTL	O
CB26	DDR0_CS_N[6]	SSTL	O
CB28	DDR0_CS_N[3]	SSTL	O
CB30	DDR0_DQ[37]	SSTL	I/O
CB32	DDR0_DQS_DN[13]	SSTL	I/O
CB34	DDR0_DQ[39]	SSTL	I/O
CB36	VSS	GND	

Table 8-2. Land Number (Sheet 22 of 48)

Land No.	Land Name	Buffer Type	Direction
CB38	DDR0_DQ[48]	SSTL	I/O
CB4	DDR0_DQ[09]	SSTL	I/O
CB40	DDR0_DQS_DN[06]	SSTL	I/O
CB42	DDR0_DQ[55]	SSTL	I/O
CB44	SVIDCLK	ODCMOS	O
CB46	VSS	GND	
CB48	VSS	GND	
CB50	VSS	GND	
CB52	VSS	GND	
CB54	ERROR_N[1]	ODCMOS	O
CB56	VSS	GND	
CB6	VSS	GND	
CB8	VSS	GND	
CC11	DDR0_DQS_DN[12]	SSTL	I/O
CC13	VSS	GND	
CC15	DDR0_ECC[1]	SSTL	I/O
CC17	DDR0_DQS_DP[08]	SSTL	I/O
CC19	DDR01_RCOMP[1]	Analog	I
CC21	DDR0_PAR_ERR_N	SSTL	I
CC23	DDR0_CS_N[2]	SSTL	O
CC25	DDR0_CS_N[7]	SSTL	O
CC27	DDR0_ODT[5]	SSTL	O
CC29	VSS	GND	
CC3	VSS	GND	
CC31	DDR0_DQ[33]	SSTL	I/O
CC33	DDR0_DQS_DP[04]	SSTL	I/O
CC35	DDR0_DQ[35]	SSTL	I/O
CC37	DDR0_DQ[52]	SSTL	I/O
CC39	DDR0_DQS_DP[15]	SSTL	I/O
CC41	DDR0_DQ[54]	SSTL	I/O
CC43	VSS	GND	
CC45	VTTA	PWR	
CC47	VSS	GND	
CC49	VSS	GND	
CC5	DDR0_DQS_DP[10]	SSTL	I/O
CC51	CAT_ERR_N	ODCMOS	I/O
CC53	QPI_RBIAS_SENSE	Analog	I
CC55	QPI1_DRX_DP[00]	QPI	I
CC7	DDR0_DQ[00]	SSTL	I/O
CC9	VSS	GND	
CD10	DDR0_DQS_DN[03]	SSTL	I/O
CD12	DDR0_DQ[27]	SSTL	I/O



Table 8-2. Land Number (Sheet 23 of 48)

Land No.	Land Name	Buffer Type	Direction
CD14	DDR0_ECC[5]	SSTL	I/O
CD16	DDR0_DQS_DP[17]	SSTL	I/O
CD18	VSS	GND	
CD20	VCCD_01	PWR	
CD22	VCCD_01	PWR	
CD24	VCCD_01	PWR	
CD26	VCCD_01	PWR	
CD28	VCCD_01	PWR	
CD30	DDR0_DQ[36]	SSTL	I/O
CD32	DDR0_DQS_DP[13]	SSTL	I/O
CD34	DDR0_DQ[38]	SSTL	I/O
CD36	VSS	GND	
CD38	DDR0_DQ[49]	SSTL	I/O
CD4	DDR0_DQS_DN[10]	SSTL	I/O
CD40	DDR0_DQS_DP[06]	SSTL	I/O
CD42	DDR0_DQ[51]	SSTL	I/O
CD44	RSVD		
CD46	QPI0_DTX_DP[10]	QPI	O
CD48	QPI0_DTX_DP[15]	QPI	O
CD50	QPI0_DTX_DP[16]	QPI	O
CD52	QPI0_DTX_DP[17]	QPI	O
CD54	QPI1_DRX_DP[02]	QPI	I
CD56	QPI1_DRX_DP[01]	QPI	I
CD6	VSS	GND	
CD8	DDR0_DQ[01]	SSTL	I/O
CE11	DDR0_DQS_DP[03]	SSTL	I/O
CE13	VSS	GND	
CE15	DDR0_ECC[0]	SSTL	I/O
CE17	DDR0_DQS_DN[08]	SSTL	I/O
CE19	DDR0_CKE[5]	SSTL	O
CE21	DDR0_CLK_DN[2]	SSTL	O
CE23	DDR0_CLK_DN[1]	SSTL	O
CE25	DDR0_ODT[0]	SSTL	O
CE27	DDR0_ODT[1]	SSTL	O
CE29	DDR0_RAS_N	SSTL	O
CE3	DDR0_DQS_DN[01]	SSTL	I/O
CE31	DDR0_DQ[32]	SSTL	I/O
CE33	DDR0_DQS_DN[04]	SSTL	I/O
CE35	DDR0_DQ[34]	SSTL	I/O
CE37	DDR0_DQ[53]	SSTL	I/O
CE39	DDR0_DQS_DN[15]	SSTL	I/O
CE41	DDR0_DQ[50]	SSTL	I/O

Table 8-2. Land Number (Sheet 24 of 48)

Land No.	Land Name	Buffer Type	Direction
CE43	RSVD		
CE45	QPI0_CLKTX_DP	QPI	O
CE47	QPI0_DTX_DP[14]	QPI	O
CE49	QPI0_DTX_DP[19]	QPI	O
CE5	VSS	GND	
CE51	QPI0_DTX_DP[18]	QPI	O
CE53	QPI_RBIAS	Analog	I/O
CE55	QPI1_DRX_DN[00]	QPI	I
CE7	DDR0_DQS_DP[09]	SSTL	I/O
CE9	VSS	GND	
CF10	DDR0_DQ[31]	SSTL	I/O
CF12	VSS	GND	
CF14	VSS	GND	
CF16	DDR0_DQS_DN[17]	SSTL	I/O
CF18	DDR0_ECC[3]	SSTL	I/O
CF20	DDR0_CKE[4]	SSTL	O
CF22	DDR0_CLK_DN[3]	SSTL	O
CF24	DDR0_CLK_DN[0]	SSTL	O
CF26	DDR0_CS_N[5]	SSTL	O
CF28	DDR0_ODT[3]	SSTL	O
CF30	VSS	GND	
CF32	VSS	GND	
CF34	VSS	GND	
CF36	VSS	GND	
CF38	VSS	GND	
CF4	DDR0_DQS_DP[01]	SSTL	I/O
CF40	VSS	GND	
CF42	VSS	GND	
CF44	RSVD		
CF46	QPI0_DTX_DN[10]	QPI	O
CF48	QPI0_DTX_DN[15]	QPI	O
CF50	QPI0_DTX_DN[16]	QPI	O
CF52	QPI0_DTX_DN[17]	QPI	O
CF54	QPI1_DRX_DN[02]	QPI	I
CF56	QPI1_DRX_DN[01]	QPI	I
CF6	VSS	GND	
CF8	DDR0_DQS_DN[09]	SSTL	I/O
CG11	RSVD		
CG13	DDR0_DQ[20]	SSTL	I/O
CG15	VSS	GND	
CG17	DDR0_ECC[6]	SSTL	I/O
CG19	DDR0_MA[14]	SSTL	O



Table 8-2. Land Number (Sheet 25 of 48)

Land No.	Land Name	Buffer Type	Direction
CG21	DDR0_CLK_DP[2]	SSTL	O
CG23	DDR0_CLK_DP[1]	SSTL	O
CG25	DDR0_MA[02]	SSTL	O
CG27	DDR0_CS_N[4]	SSTL	O
CG29	DDR0_MA[13]	SSTL	O
CG3	DDR0_DQ[14]	SSTL	I/O
CG31	VSS	GND	
CG33	VSS	GND	
CG35	VSS	GND	
CG37	VSS	GND	
CG39	VSS	GND	
CG41	VSS	GND	
CG43	VSS	GND	
CG45	QPI0_CLKTX_DN	QPI	O
CG47	QPI0_DTX_DN[14]	QPI	O
CG49	QPI0_DTX_DN[19]	QPI	O
CG5	DDR0_DQ[15]	SSTL	I/O
CG51	QPI0_DTX_DN[18]	QPI	O
CG53	VSS	GND	
CG55	VTTA	PWR	
CG7	DDR0_DQS_DN[00]	SSTL	I/O
CG9	VSS	GND	
CH10	DDR0_DQ[30]	SSTL	I/O
CH12	VSS	GND	
CH14	DDR0_DQS_DN[02]	SSTL	I/O
CH16	VSS	GND	
CH18	DDR0_ECC[2]	SSTL	I/O
CH20	DDR0_CKE[2]	SSTL	O
CH22	DDR0_CLK_DP[3]	SSTL	O
CH24	DDR0_CLK_DP[0]	SSTL	O
CH26	DDR0_CS_N[1]	SSTL	O
CH28	DDR0_ODT[2]	SSTL	O
CH30	DDR0_DQ[45]	SSTL	I/O
CH32	DDR0_DQS_DN[14]	SSTL	I/O
CH34	DDR0_DQ[47]	SSTL	I/O
CH36	VSS	GND	
CH38	DDR0_DQ[56]	SSTL	I/O
CH4	DDR0_DQ[10]	SSTL	I/O
CH40	DDR0_DQS_DN[07]	SSTL	I/O
CH42	DDR0_DQ[58]	SSTL	I/O
CH44	VSS	GND	
CH46	VSS	GND	

Table 8-2. Land Number (Sheet 26 of 48)

Land No.	Land Name	Buffer Type	Direction
CH48	VSS	GND	
CH50	VSS	GND	
CH52	VSS	GND	
CH54	VSS	GND	
CH56	EAR_N	ODCMOS	I/O
CH6	VSS	GND	
CH8	DDR0_DQS_DP[00]	SSTL	I/O
CJ11	VSS	GND	
CJ13	DDR0_DQS_DP[11]	SSTL	I/O
CJ15	DDR0_DQ[22]	SSTL	I/O
CJ17	VSS	GND	
CJ19	VCCD_01	PWR	
CJ21	VCCD_01	PWR	
CJ23	VCCD_01	PWR	
CJ25	VCCD_01	PWR	
CJ27	VCCD_01	PWR	
CJ29	VSS	GND	
CJ3	VSS	GND	
CJ31	DDR0_DQ[41]	SSTL	I/O
CJ33	DDR0_DQS_DP[05]	SSTL	I/O
CJ35	DDR0_DQ[43]	SSTL	I/O
CJ37	DDR0_DQ[60]	SSTL	I/O
CJ39	DDR0_DQS_DP[16]	SSTL	I/O
CJ41	DDR0_DQ[62]	SSTL	I/O
CJ43	VSS	GND	
CJ45	VSS	GND	
CJ47	VSS	GND	
CJ49	VTTA	PWR	
CJ5	DDR0_DQ[11]	SSTL	I/O
CJ51	VSS	GND	
CJ53	QPI1_DRX_DP[09]	QPI	I
CJ55	QPI1_DRX_DP[03]	QPI	I
CJ7	DDR0_DQ[06]	SSTL	I/O
CJ9	VSS	GND	
CK10	VSS	GND	
CK12	DDR0_DQ[16]	SSTL	I/O
CK14	DDR0_DQS_DP[02]	SSTL	I/O
CK16	DDR0_DQ[18]	SSTL	I/O
CK18	DDR0_ECC[7]	SSTL	I/O
CK20	DDR0_MA[12]	SSTL	O
CK22	DDR0_MA[08]	SSTL	O
CK24	DDR0_MA[03]	SSTL	O



Table 8-2. Land Number (Sheet 27 of 48)

Land No.	Land Name	Buffer Type	Direction
CK26	DDR0_MA[10]	SSTL	O
CK28	DDR0_CS_N[9]	SSTL	O
CK30	DDR0_DQ[44]	SSTL	I/O
CK32	DDR0_DQS_DP[14]	SSTL	I/O
CK34	DDR0_DQ[46]	SSTL	I/O
CK36	VSS	GND	
CK38	DDR0_DQ[57]	SSTL	I/O
CK4	VSS	GND	
CK40	DDR0_DQS_DP[07]	SSTL	I/O
CK42	DDR0_DQ[59]	SSTL	I/O
CK44	RESET_N	CMOS	I
CK46	QPI1_DRX_DP[18]	QPI	I
CK48	QPI1_DRX_DP[16]	QPI	I
CK50	QPI1_DRX_DN[14]	QPI	I
CK52	QPI1_DRX_DP[10]	QPI	I
CK54	QPI1_DRX_DP[05]	QPI	I
CK56	QPI1_DRX_DP[04]	QPI	I
CK6	VSS	GND	
CK8	DDR0_DQ[02]	SSTL	I/O
CL11	DDR0_DQ[21]	SSTL	I/O
CL13	DDR0_DQS_DN[11]	SSTL	I/O
CL15	DDR0_DQ[23]	SSTL	I/O
CL17	VSS	GND	
CL19	DDR0_CKE[0]	SSTL	O
CL21	DDR0_MA[11]	SSTL	O
CL23	DDR0_MA[05]	SSTL	O
CL25	DDR0_MA[00]	SSTL	O
CL27	DDR0_CS_N[8]	SSTL	O
CL29	DDR0_CAS_N	SSTL	O
CL3	DDR1_DQ[05]	SSTL	I/O
CL31	DDR0_DQ[40]	SSTL	I/O
CL33	DDR0_DQS_DN[05]	SSTL	I/O
CL35	DDR0_DQ[42]	SSTL	I/O
CL37	DDR0_DQ[61]	SSTL	I/O
CL39	DDR0_DQS_DN[16]	SSTL	I/O
CL41	DDR0_DQ[63]	SSTL	I/O
CL43	VSS	GND	
CL45	QPI1_DRX_DP[19]	QPI	I
CL47	QPI1_DRX_DP[17]	QPI	I
CL49	QPI1_DRX_DN[15]	QPI	I
CL5	VSS	GND	
CL51	QPI1_DRX_DN[13]	QPI	I

Table 8-2. Land Number (Sheet 28 of 48)

Land No.	Land Name	Buffer Type	Direction
CL53	QPI1_DRX_DN[09]	QPI	I
CL55	QPI1_DRX_DN[03]	QPI	I
CL7	DDR0_DQ[07]	SSTL	I/O
CL9	DDR0_DQ[03]	SSTL	I/O
CM10	VSS	GND	
CM12	DDR0_DQ[17]	SSTL	I/O
CM14	VSS	GND	
CM16	DDR0_DQ[19]	SSTL	I/O
CM18	DDR0_CKE[1]	SSTL	O
CM20	DDR0_BA[2]	SSTL	O
CM22	DDR0_MA[07]	SSTL	O
CM24	DDR0_MA[04]	SSTL	O
CM26	DDR0_MA_PAR	SSTL	O
CM28	DDR0_BA[0]	SSTL	O
CM30	VSS	GND	
CM32	VSS	GND	
CM34	VSS	GND	
CM36	VSS	GND	
CM38	VSS	GND	
CM4	DDR1_DQ[04]	SSTL	I/O
CM40	VSS	GND	
CM42	VSS	GND	
CM44	BCLK0_DN	CMOS	I
CM46	QPI1_DRX_DN[18]	QPI	I
CM48	QPI1_DRX_DN[16]	QPI	I
CM50	QPI1_DRX_DP[14]	QPI	I
CM52	QPI1_DRX_DN[10]	QPI	I
CM54	QPI1_DRX_DN[05]	QPI	I
CM56	QPI1_DRX_DN[04]	QPI	I
CM6	VSS	GND	
CM8	VSS	GND	
CN11	VSS	GND	
CN13	VSS	GND	
CN15	VSS	GND	
CN17	VSS	GND	
CN19	DDR0_MA[15]	SSTL	O
CN21	DDR0_MA[09]	SSTL	O
CN23	DDR0_MA[06]	SSTL	O
CN25	DDR0_CS_N[0]	SSTL	O
CN27	DDR0_BA[1]	SSTL	O
CN29	DDR0_WE_N	SSTL	O
CN3	VSS	GND	



Table 8-2. Land Number (Sheet 29 of 48)

Land No.	Land Name	Buffer Type	Direction
CN31	VSS	GND	
CN33	VSS	GND	
CN35	VSS	GND	
CN37	VSS	GND	
CN39	VSS	GND	
CN41	DDR_VREFDQTX_C01	DC	O
CN43	BCLK0_DP	CMOS	I
CN45	QPI1_DRX_DN[19]	QPI	I
CN47	QPI1_DRX_DN[17]	QPI	I
CN49	QPI1_DRX_DP[15]	QPI	I
CN5	VSS	GND	
CN51	QPI1_DRX_DP[13]	QPI	I
CN53	VSS	GND	
CN55	VSS	GND	
CN57	VSS	GND	
CN7	VSS	GND	
CN9	VSS	GND	
CP10	DDR1_DQ[19]	SSTL	I/O
CP12	VSS	GND	
CP14	DDR1_DQS_DN[12]	SSTL	I/O
CP16	VSS	GND	
CP18	DDR0_CKE[3]	SSTL	O
CP2	DDR1_DQ[01]	SSTL	I/O
CP20	VCCD_01	PWR	
CP22	VCCD_01	PWR	
CP24	VCCD_01	PWR	
CP26	VCCD_01	PWR	
CP28	VCCD_01	PWR	
CP30	DDR1_DQ[33]	SSTL	I/O
CP32	DDR1_DQS_DP[04]	SSTL	I/O
CP34	DDR1_DQ[35]	SSTL	I/O
CP36	VSS	GND	
CP38	DDR1_DQS_DP[15]	SSTL	I/O
CP4	DDR1_DQ[00]	SSTL	I/O
CP40	VSS	GND	
CP42	VSS	GND	
CP44	VSS	GND	
CP46	VSS	GND	
CP48	VSS	GND	
CP50	VSS	GND	
CP52	VSS	GND	
CP54	RSVD		

Table 8-2. Land Number (Sheet 30 of 48)

Land No.	Land Name	Buffer Type	Direction
CP56	VSS	GND	
CP58	QPI1_DRX_DP[06]	QPI	I
CP6	DDR1_DQ[20]	SSTL	I/O
CP8	DDR1_DQS_DP[11]	SSTL	I/O
CR1	DDR1_DQS_DN[09]	SSTL	I/O
CR11	VSS	GND	
CR13	DDR1_DQ[24]	SSTL	I/O
CR15	DDR1_DQS_DN[03]	SSTL	I/O
CR17	DDR1_DQ[26]	SSTL	I/O
CR19	DDR1_CKE[4]	SSTL	O
CR21	DDR1_CS_N[8]	SSTL	O
CR23	DDR1_CS_N[2]	SSTL	O
CR25	DDR0_MA[01]	SSTL	O
CR27	DDR1_CS_N[3]	SSTL	O
CR29	DDR1_DQ[37]	SSTL	I/O
CR3	DDR1_DQS_DP[00]	SSTL	I/O
CR31	DDR1_DQS_DN[13]	SSTL	I/O
CR33	DDR1_DQ[39]	SSTL	I/O
CR35	VSS	GND	
CR37	DDR1_DQ[48]	SSTL	I/O
CR39	DDR1_DQS_DN[06]	SSTL	I/O
CR41	DDR1_DQ[50]	SSTL	I/O
CR43	SVIDALERT_N	CMOS	I
CR45	VTTA	PWR	
CR47	VSS	GND	
CR49	VSS	GND	
CR5	VSS	GND	
CR51	VTTA	PWR	
CR53	QPI1_DRX_DN[11]	QPI	I
CR55	QPI1_CLKRX_DP	QPI	I
CR57	QPI1_DRX_DP[07]	QPI	I
CR7	DDR1_DQ[16]	SSTL	I/O
CR9	VSS	GND	
CT10	DDR1_DQ[18]	SSTL	I/O
CT12	DDR1_DQ[28]	SSTL	I/O
CT14	DDR1_DQS_DP[12]	SSTL	I/O
CT16	DDR1_DQ[30]	SSTL	I/O
CT18	DDR1_CKE[5]	SSTL	O
CT2	DDR1_DQS_DP[09]	SSTL	I/O
CT20	DDR1_CKE[0]	SSTL	O
CT22	DDR1_ODT[0]	SSTL	O
CT24	DDR1_CS_N[5]	SSTL	O



Table 8-2. Land Number (Sheet 31 of 48)

Land No.	Land Name	Buffer Type	Direction
CT26	DDR1_CS_N[7]	SSTL	O
CT28	VSS	GND	
CT30	DDR1_DQ[32]	SSTL	I/O
CT32	DDR1_DQS_DN[04]	SSTL	I/O
CT34	DDR1_DQ[34]	SSTL	I/O
CT36	DDR1_DQ[52]	SSTL	I/O
CT38	DDR1_DQS_DN[15]	SSTL	I/O
CT4	DDR1_DQS_DN[00]	SSTL	I/O
CT40	DDR1_DQ[54]	SSTL	I/O
CT42	VSS	GND	
CT44	QPI1_DTX_DP[14]	QPI	O
CT46	QPI1_DTX_DP[08]	QPI	O
CT48	QPI1_DTX_DP[00]	QPI	O
CT50	QPI1_DTX_DP[01]	QPI	O
CT52	QPI1_DRX_DN[12]	QPI	I
CT54	TRST_N	CMOS	I
CT56	QPI1_DRX_DP[08]	QPI	I
CT58	QPI1_DRX_DN[06]	QPI	I
CT6	DDR1_DQ[21]	SSTL	I/O
CT8	DDR1_DQS_DN[11]	SSTL	I/O
CU1	VSS	GND	
CU11	VSS	GND	
CU13	DDR1_DQ[25]	SSTL	I/O
CU15	DDR1_DQS_DP[03]	SSTL	I/O
CU17	DDR1_DQ[27]	SSTL	I/O
CU19	DDR1_CKE[1]	SSTL	O
CU21	DDR1_PAR_ERR_N	SSTL	I
CU23	DDR1_CS_N[1]	SSTL	O
CU25	DDR1_CS_N[4]	SSTL	O
CU27	DDR1_ODT[4]	SSTL	O
CU29	DDR1_DQ[36]	SSTL	I/O
CU3	VSS	GND	
CU31	DDR1_DQS_DP[13]	SSTL	I/O
CU33	DDR1_DQ[38]	SSTL	I/O
CU35	VSS	GND	
CU37	DDR1_DQ[49]	SSTL	I/O
CU39	DDR1_DQS_DP[06]	SSTL	I/O
CU41	DDR1_DQ[51]	SSTL	I/O
CU43	QPI1_DTX_DP[17]	QPI	O
CU45	QPI1_DTX_DP[11]	QPI	O
CU47	QPI1_DTX_DP[05]	QPI	O
CU49	QPI1_DTX_DP[02]	QPI	O

Table 8-2. Land Number (Sheet 32 of 48)

Land No.	Land Name	Buffer Type	Direction
CU5	VSS	GND	
CU51	QPI_VREF_CAP	QPI	I/O
CU53	QPI1_DRX_DP[11]	QPI	I
CU55	QPI1_CLKRX_DN	QPI	I
CU57	QPI1_DRX_DN[07]	QPI	I
CU7	DDR1_DQ[17]	SSTL	I/O
CU9	DDR1_DQS_DP[02]	SSTL	I/O
CV10	DDR1_DQ[23]	SSTL	I/O
CV12	DDR1_DQ[29]	SSTL	I/O
CV14	VSS	GND	
CV16	DDR1_DQ[31]	SSTL	I/O
CV18	VSS	GND	
CV2	DDR1_DQ[06]	SSTL	I/O
CV20	DDR1_CLK_DN[0]	SSTL	O
CV22	DDR1_CLK_DN[1]	SSTL	O
CV24	DDR1_CLK_DP[2]	SSTL	O
CV26	DDR1_ODT[3]	SSTL	O
CV28	DDR1_WE_N	SSTL	O
CV30	VSS	GND	
CV32	VSS	GND	
CV34	VSS	GND	
CV36	DDR1_DQ[53]	SSTL	I/O
CV38	VSS	GND	
CV4	DDR1_DQ[02]	SSTL	I/O
CV40	DDR1_DQ[55]	SSTL	I/O
CV42	VSS	GND	
CV44	QPI1_DTX_DN[14]	QPI	O
CV46	QPI1_DTX_DN[08]	QPI	O
CV48	QPI1_DTX_DN[00]	QPI	O
CV50	QPI1_DTX_DN[01]	QPI	O
CV52	QPI1_DRX_DP[12]	QPI	I
CV54	VSS	GND	
CV56	QPI1_DRX_DN[08]	QPI	I
CV58	VSS	GND	
CV6	VSS	GND	
CV8	DDR1_DQS_DN[02]	SSTL	I/O
CW1	TEST1		O
CW11	VSS	GND	
CW13	VSS	GND	
CW15	VSS	GND	
CW17	DRAM_PWR_OK_C01	CMOS1.5v	I
CW19	VCCD_01	PWR	



Table 8-2. Land Number (Sheet 33 of 48)

Land No.	Land Name	Buffer Type	Direction
CW21	VCCD_01	PWR	
CW23	VCCD_01	PWR	
CW25	VCCD_01	PWR	
CW27	VCCD_01	PWR	
CW29	VSS	GND	
CW3	DDR1_DQ[07]	SSTL	I/O
CW31	VSS	GND	
CW33	VSS	GND	
CW35	VSS	GND	
CW37	VSS	GND	
CW39	VSS	GND	
CW41	DDR_SDA_C01	ODCMOS	I/O
CW43	QPI1_DTX_DN[17]	QPI	O
CW45	QPI1_DTX_DN[11]	QPI	O
CW47	QPI1_DTX_DN[05]	QPI	O
CW49	QPI1_DTX_DN[02]	QPI	O
CW5	VSS	GND	
CW51	VSS	GND	
CW53	VSS	GND	
CW55	VSS	GND	
CW57	VSS	GND	
CW7	VSS	GND	
CW9	DDR1_DQ[22]	SSTL	I/O
CY10	VSS	GND	
CY12	VSS	GND	
CY14	DDR1_DQS_DP[17]	SSTL	I/O
CY16	VSS	GND	
CY18	DDR1_CKE[2]	SSTL	O
CY2	VSS	GND	
CY20	DDR1_CLK_DP[0]	SSTL	O
CY22	DDR1_CLK_DP[1]	SSTL	O
CY24	DDR1_CLK_DN[2]	SSTL	O
CY26	DDR1_ODT[2]	SSTL	O
CY28	DDR1_ODT[5]	SSTL	O
CY30	DDR1_CAS_N	SSTL	O
CY32	DDR1_DQ[45]	SSTL	I/O
CY34	DDR1_DQS_DN[05]	SSTL	I/O
CY36	VSS	GND	
CY38	DDR1_DQS_DN[16]	SSTL	I/O
CY4	DDR1_DQ[03]	SSTL	I/O
CY40	VSS	GND	
CY42	DDR_SCL_C01	ODCMOS	I/O

Table 8-2. Land Number (Sheet 34 of 48)

Land No.	Land Name	Buffer Type	Direction
CY44	VSS	GND	
CY46	RSVD		
CY48	RSVD		
CY50	VSS	GND	
CY52	SOCKET_ID[0]	CMOS	I
CY54	QPI1_CLKTX_DN	QPI	O
CY56	RSVD		
CY58	RSVD		
CY6	DDR1_DQ[12]	SSTL	I/O
CY8	VSS	GND	
D10	DDR3_DQS_DP[04]	SSTL	I/O
D12	DDR3_DQ[32]	SSTL	I/O
D14	DDR3_ODT[4]	SSTL	O
D16	DDR3_CS_N[8]	SSTL	O
D18	DDR3_MA[10]	SSTL	O
D2	VSS	GND	
D20	DDR3_MA[04]	SSTL	O
D22	DDR3_MA[08]	SSTL	O
D24	DDR3_MA[14]	SSTL	O
D26	VSS	GND	
D32	DDR3_DQ[18]	SSTL	I/O
D34	DDR3_DQS_DP[11]	SSTL	I/O
D36	VSS	GND	
D38	DDR3_DQS_DP[00]	SSTL	I/O
D4	TEST3		O
D40	DDR3_DQ[05]	SSTL	I/O
D42	DMI_TX_DN[0]	PCIEX	O
D44	DMI_TX_DN[2]	PCIEX	O
D46	RSVD		
D48	DMI_RX_DN[1]	PCIEX	I
D50	DMI_RX_DN[3]	PCIEX	I
D52	PE1A_RX_DP[1]	PCIEX3	I
D54	PE1A_RX_DP[2]	PCIEX3	I
D56	RSVD		
D6	DDR3_DQ[53]	SSTL	I/O
D8	VSS	GND	
DA11	VSS	GND	
DA13	DDR1_ECC[4]	SSTL	I/O
DA15	DDR1_ECC[6]	SSTL	I/O
DA17	DDR1_CKE[3]	SSTL	O
DA19	DDR1_MA[09]	SSTL	O
DA21	DDR1_CLK_DN[3]	SSTL	O

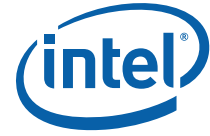


Table 8-2. Land Number (Sheet 35 of 48)

Land No.	Land Name	Buffer Type	Direction
DA23	DDR1_MA[03]	SSTL	O
DA25	DDR1_ODT[1]	SSTL	O
DA27	DDR1_CS_N[9]	SSTL	O
DA29	DDR1_CS_N[6]	SSTL	O
DA3	VSS	GND	
DA31	DDR1_DQ[44]	SSTL	I/O
DA33	DDR1_DQ[40]	SSTL	I/O
DA35	DDR1_DQ[43]	SSTL	I/O
DA37	DDR1_DQ[60]	SSTL	I/O
DA39	DDR1_DQ[62]	SSTL	I/O
DA41	VSS	GND	
DA43	VSS	GND	
DA45	VSS	GND	
DA47	VSS	GND	
DA49	VTTA	PWR	
DA5	VSS	GND	
DA51	VSS	GND	
DA53	QPI1_DTX_DP[03]	QPI	O
DA55	SAFE_MODE_BOOT	CMOS	I
DA57	RSVD		
DA7	DDR1_DQ[08]	SSTL	I/O
DA9	VSS	GND	
DB10	DDR1_DQ[14]	SSTL	I/O
DB12	VSS	GND	
DB14	DDR1_DQS_DN[17]	SSTL	I/O
DB16	DDR1_ECC[3]	SSTL	I/O
DB18	DDR1_MA[14]	SSTL	O
DB2	VSS	GND	
DB20	DDR1_MA[08]	SSTL	O
DB22	DDR1_MA[04]	SSTL	O
DB24	DDR1_CS_N[0]	SSTL	O
DB26	DDR1_BA[0]	SSTL	O
DB28	DDR1_RAS_N	SSTL	O
DB30	DDR1_MA[13]	SSTL	O
DB32	VSS	GND	
DB34	DDR1_DQS_DP[05]	SSTL	I/O
DB36	VSS	GND	
DB38	DDR1_DQS_DP[16]	SSTL	I/O
DB4	TEST0		O
DB40	DDR1_DQ[59]	SSTL	I/O
DB42	QPI1_DTX_DP[19]	QPI	O
DB44	QPI1_DTX_DP[16]	QPI	O

Table 8-2. Land Number (Sheet 36 of 48)

Land No.	Land Name	Buffer Type	Direction
DB46	QPI1_DTX_DP[13]	QPI	O
DB48	QPI1_DTX_DP[10]	QPI	O
DB50	QPI1_DTX_DN[07]	QPI	O
DB52	QPI1_DTX_DN[04]	QPI	O
DB54	QPI1_CLKTX_DP	QPI	O
DB56	RSVD		
DB58	VSS	GND	
DB6	DDR1_DQ[13]	SSTL	I/O
DB8	DDR1_DQS_DN[10]	SSTL	I/O
DC11	DDR1_DQ[10]	SSTL	I/O
DC13	DDR1_ECC[5]	SSTL	I/O
DC15	DDR1_DQS_DP[08]	SSTL	I/O
DC17	DDR1_MA[15]	SSTL	O
DC19	DDR1_MA[12]	SSTL	O
DC21	DDR1_CLK_DP[3]	SSTL	O
DC23	DDR1_MA[00]	SSTL	O
DC25	DDR1_BA[1]	SSTL	O
DC3	VSS	GND	
DC33	DDR1_DQS_DP[14]	SSTL	I/O
DC35	DDR1_DQ[42]	SSTL	I/O
DC37	DDR1_DQ[61]	SSTL	I/O
DC39	DDR1_DQS_DP[07]	SSTL	I/O
DC41	VSS	GND	
DC43	QPI1_DTX_DN[18]	QPI	O
DC45	QPI1_DTX_DN[15]	QPI	O
DC47	QPI1_DTX_DN[12]	QPI	O
DC49	QPI1_DTX_DP[09]	QPI	O
DC5	VSS	GND	
DC51	QPI1_DTX_DP[06]	QPI	O
DC53	QPI1_DTX_DN[03]	QPI	O
DC55	RSVD		
DC7	DDR1_DQ[09]	SSTL	I/O
DC9	DDR1_DQS_DN[01]	SSTL	I/O
DD10	VSS	GND	
DD12	VSS	GND	
DD14	VSS	GND	
DD16	DDR1_ECC[2]	SSTL	I/O
DD18	VCCD_01	PWR	
DD20	VCCD_01	PWR	
DD22	VCCD_01	PWR	
DD24	VCCD_01	PWR	
DD26	VCCD_01	PWR	



Table 8-2. Land Number (Sheet 37 of 48)

Land No.	Land Name	Buffer Type	Direction
DD32	DDR1_DQ[41]	SSTL	I/O
DD34	VSS	GND	
DD36	VSS	GND	
DD38	VSS	GND	
DD40	DDR1_DQ[58]	SSTL	I/O
DD42	QPI1_DTX_DN[19]	QPI	O
DD44	QPI1_DTX_DN[16]	QPI	O
DD46	QPI1_DTX_DN[13]	QPI	O
DD48	QPI1_DTX_DN[10]	QPI	O
DD50	QPI1_DTX_DP[07]	QPI	O
DD52	QPI1_DTX_DP[04]	QPI	O
DD54	RSVD		
DD6	VSS	GND	
DD8	DDR1_DQS_DP[10]	SSTL	I/O
DE11	DDR1_DQ[11]	SSTL	I/O
DE13	DDR1_ECC[0]	SSTL	I/O
DE15	DDR1_DQS_DN[08]	SSTL	I/O
DE17	VSS	GND	
DE19	DDR1_MA[11]	SSTL	O
DE21	DDR1_MA[06]	SSTL	O
DE23	DDR1_MA[01]	SSTL	O
DE25	DDR1_MA_PAR	SSTL	O
DE33	DDR1_DQS_DN[14]	SSTL	I/O
DE35	DDR1_DQ[47]	SSTL	I/O
DE37	DDR1_DQ[56]	SSTL	I/O
DE39	DDR1_DQS_DN[07]	SSTL	I/O
DE41	VSS	GND	
DE43	QPI1_DTX_DP[18]	QPI	O
DE45	QPI1_DTX_DP[15]	QPI	O
DE47	QPI1_DTX_DP[12]	QPI	O
DE49	QPI1_DTX_DN[09]	QPI	O
DE51	QPI1_DTX_DN[06]	QPI	O
DE53	VSS	GND	
DE55	RSVD		
DE7	VSS	GND	
DE9	DDR1_DQS_DP[01]	SSTL	I/O
DF10	DDR1_DQ[15]	SSTL	I/O
DF12	VSS	GND	
DF14	DDR1_ECC[1]	SSTL	I/O
DF16	DDR1_ECC[7]	SSTL	I/O
DF18	DDR1_BA[2]	SSTL	O
DF20	DDR1_MA[07]	SSTL	O

Table 8-2. Land Number (Sheet 38 of 48)

Land No.	Land Name	Buffer Type	Direction
DF22	DDR1_MA[05]	SSTL	O
DF24	DDR1_MA[02]	SSTL	O
DF26	DDR1_MA[10]	SSTL	O
DF34	DDR1_DQ[46]	SSTL	I/O
DF36	VSS	GND	
DF38	DDR1_DQ[57]	SSTL	I/O
DF40	DDR1_DQ[63]	SSTL	I/O
DF42	VSS	GND	
DF44	VSS	GND	
DF46	VSS	GND	
DF48	VSS	GND	
DF50	VSS	GND	
DF52	VSS	GND	
DF8	VSS	GND	
E1	VSS	GND	
E11	DDR3_DQS_DP[13]	SSTL	I/O
E13	MEM_HOT_C23_N	ODCMOS	I/O
E15	DDR3_CS_N[7]	SSTL	O
E17	DDR3_ODT[2]	SSTL	O
E19	DDR3_BA[1]	SSTL	O
E21	DDR3_MA[01]	SSTL	O
E23	DDR3_MA[12]	SSTL	O
E25	DDR3_ECC[2]	SSTL	I/O
E27	DDR3_DQS_DP[08]	SSTL	I/O
E29	VSS	GND	
E3	VSS	GND	
E31	VSS	GND	
E33	DDR3_DQS_DP[02]	SSTL	I/O
E35	DDR3_DQ[20]	SSTL	I/O
E37	DDR3_DQ[03]	SSTL	I/O
E39	DDR3_DQS_DP[09]	SSTL	I/O
E41	VSS	GND	
E43	DMI_TX_DN[1]	PCIEX	O
E45	DMI_TX_DN[3]	PCIEX	O
E47	DMI_RX_DN[0]	PCIEX	I
E49	DMI_RX_DN[2]	PCIEX	I
E5	VSS	GND	
E51	PE1A_RX_DN[0]	PCIEX3	I
E53	RSVD		
E55	PE1A_RX_DP[3]	PCIEX3	I
E57	RSVD		
E7	DDR3_DQ[48]	SSTL	I/O



Table 8-2. Land Number (Sheet 39 of 48)

Land No.	Land Name	Buffer Type	Direction
E9	DDR3_DQ[35]	SSTL	I/O
F10	DDR3_DQ[38]	SSTL	I/O
F12	DDR3_DQ[36]	SSTL	I/O
F14	DDR3_CS_N[2]	SSTL	O
F16	DDR3_CS_N[6]	SSTL	O
F18	DDR3_ODT[1]	SSTL	O
F2	TEST2		O
F20	DDR3_MA[02]	SSTL	O
F22	DDR3_MA[06]	SSTL	O
F24	DDR3_MA[15]	SSTL	O
F26	DDR3_ECC[6]	SSTL	I/O
F28	DDR3_DQS_DP[17]	SSTL	I/O
F30	DDR3_ECC[4]	SSTL	I/O
F32	DDR3_DQ[19]	SSTL	I/O
F34	DDR3_DQ[17]	SSTL	I/O
F36	VSS	GND	
F38	DDR3_DQ[06]	SSTL	I/O
F4	DDR3_DQ[60]	SSTL	I/O
F40	DDR3_DQ[04]	SSTL	I/O
F42	VSS	GND	
F44	VSS	GND	
F46	RSVD		
F48	VSS	GND	
F50	VSS	GND	
F52	PE1A_RX_DN[1]	PCIEX3	I
F54	PE1A_RX_DN[2]	PCIEX3	I
F56	RSVD		
F58	RSVD		
F6	DDR3_DQ[49]	SSTL	I/O
F8	VSS	GND	
G1	VSS	GND	
G11	DDR3_DQS_DN[13]	SSTL	I/O
G13	VCCD_23	PWR	
G15	DDR3_CS_N[3]	SSTL	O
G17	DDR3_CS_N[5]	SSTL	O
G19	DDR3_CS_N[0]	SSTL	O
G21	DDR3_PAR_ERR_N	SSTL	I
G23	DDR3_MA[09]	SSTL	O
G25	VSS	GND	
G27	DDR3_DQS_DN[08]	SSTL	I/O
G29	DDR3_ECC[0]	SSTL	I/O
G3	DDR3_DQ[56]	SSTL	I/O

Table 8-2. Land Number (Sheet 40 of 48)

Land No.	Land Name	Buffer Type	Direction
G31	VSS	GND	
G33	DDR3_DQS_DN[02]	SSTL	I/O
G35	VSS	GND	
G37	VSS	GND	
G39	DDR3_DQS_DN[09]	SSTL	I/O
G41	VSS	GND	
G43	VSA	PWR	
G45	VSS	GND	
G47	VSS	GND	
G49	VSA	PWR	
G5	VSS	GND	
G51	VSS	GND	
G53	VSS	GND	
G55	PE1A_RX_DN[3]	PCIEX3	I
G57	VSS	GND	
G7	DDR3_DQS_DP[15]	SSTL	I/O
G9	VSS	GND	
H10	VSS	GND	
H12	VSS	GND	
H14	VSS	GND	
H16	VCCD_23	PWR	
H18	VCCD_23	PWR	
H2	DDR3_DQ[57]	SSTL	I/O
H20	VCCD_23	PWR	
H22	VCCD_23	PWR	
H24	VCCD_23	PWR	
H26	DDR3_ECC[7]	SSTL	I/O
H28	DDR3_DQS_DN[17]	SSTL	I/O
H30	DDR3_ECC[5]	SSTL	I/O
H32	VSS	GND	
H34	VSS	GND	
H36	DDR3_DQ[15]	SSTL	I/O
H38	VSS	GND	
H4	DDR3_DQ[61]	SSTL	I/O
H40	VSS	GND	
H42	PE1A_TX_DP[0]	PCIEX3	O
H44	PE1A_TX_DP[2]	PCIEX3	O
H46	PE1B_TX_DP[4]	PCIEX3	O
H48	PE1B_TX_DP[6]	PCIEX3	O
H50	PE3A_TX_DP[0]	PCIEX3	O
H52	VSS	GND	
H54	VSS	GND	



Table 8-2. Land Number (Sheet 41 of 48)

Land No.	Land Name	Buffer Type	Direction
H56	RSVD		
H58	RSVD		
H6	DDR3_DQS_DN[15]	SSTL	I/O
H8	VSS	GND	
J1	DDR_VREFDQRX_C23	DC	I
J11	VSS	GND	
J13	DDR3_DQ[40]	SSTL	I/O
J15	RSVD		
J17	DDR3_ODT[3]	SSTL	O
J19	DDR3_CS_N[1]	SSTL	O
J21	DDR3_CLK_DN[1]	SSTL	O
J23	DDR3_CLK_DN[0]	SSTL	O
J25	DDR3_CKE[2]	SSTL	O
J27	VSS	GND	
J29	DDR3_ECC[1]	SSTL	I/O
J3	DDR3_DQS_DP[16]	SSTL	I/O
J31	VSS	GND	
J33	VSS	GND	
J35	DDR3_DQ[11]	SSTL	I/O
J37	DDR3_DQS_DP[01]	SSTL	I/O
J39	VSS	GND	
J41	VSS	GND	
J43	PE1A_TX_DP[1]	PCIEX3	O
J45	PE1A_TX_DP[3]	PCIEX3	O
J47	PE1B_TX_DP[5]	PCIEX3	O
J49	PE1B_TX_DP[7]	PCIEX3	O
J5	VSS	GND	
J51	PE3A_TX_DP[1]	PCIEX3	O
J53	PE1B_RX_DP[4]	PCIEX3	I
J55	VSS	GND	
J57	PE1B_RX_DP[6]	PCIEX3	I
J7	DDR3_DQS_DN[06]	SSTL	I/O
J9	DDR3_DQ[42]	SSTL	I/O
K10	DDR3_DQ[46]	SSTL	I/O
K12	DDR3_DQS_DP[14]	SSTL	I/O
K14	DDR3_DQ[44]	SSTL	I/O
K16	DDR3_CS_N[9]	SSTL	O
K18	DDR3_CS_N[4]	SSTL	O
K2	VSS	GND	
K20	DDR3_CLK_DP[2]	SSTL	O
K22	DDR3_CLK_DN[3]	SSTL	O
K24	DDR3_CKE[0]	SSTL	O

Table 8-2. Land Number (Sheet 42 of 48)

Land No.	Land Name	Buffer Type	Direction
K26	VSS	GND	
K28	VSS	GND	
K30	VSS	GND	
K32	DDR3_DQ[29]	SSTL	I/O
K34	VSS	GND	
K36	DDR3_DQ[14]	SSTL	I/O
K38	DDR3_DQS_DN[10]	SSTL	I/O
K4	DDR3_DQS_DN[16]	SSTL	I/O
K40	DDR3_DQ[13]	SSTL	I/O
K42	PE1A_TX_DN[0]	PCIEX3	O
K44	PE1A_TX_DN[2]	PCIEX3	O
K46	PE1B_TX_DN[4]	PCIEX3	O
K48	PE1B_TX_DN[6]	PCIEX3	O
K50	PE3A_TX_DN[0]	PCIEX3	O
K52	PMSYNC	CMOS	I
K54	PE1B_RX_DP[5]	PCIEX3	I
K56	PE1B_RX_DP[7]	PCIEX3	I
K58	RSVD		
K6	DDR3_DQS_DP[06]	SSTL	I/O
K8	VSS	GND	
L1	DDR3_DQ[62]	SSTL	I/O
L11	DDR3_DQS_DN[05]	SSTL	I/O
L13	DDR3_DQ[41]	SSTL	I/O
L15	DRAM_PWR_OK_C23	CMOS1.5v	I
L17	DDR2_BA[1]	SSTL	O
L19	DDR3_ODT[0]	SSTL	O
L21	DDR3_CLK_DP[1]	SSTL	O
L23	DDR3_CLK_DP[0]	SSTL	O
L25	VSS	GND	
L27	DDR3_DQ[27]	SSTL	I/O
L29	VSS	GND	
L3	DDR3_DQS_DN[07]	SSTL	I/O
L31	DDR3_DQ[25]	SSTL	I/O
L33	DDR3_DQ[28]	SSTL	I/O
L35	DDR3_DQ[10]	SSTL	I/O
L37	DDR3_DQS_DN[01]	SSTL	I/O
L39	DDR3_DQ[09]	SSTL	I/O
L41	VSS	GND	
L43	PE1A_TX_DN[1]	PCIEX3	O
L45	PE1A_TX_DN[3]	PCIEX3	O
L47	PE1B_TX_DN[5]	PCIEX3	O
L49	PE1B_TX_DN[7]	PCIEX3	O



Table 8-2. Land Number (Sheet 43 of 48)

Land No.	Land Name	Buffer Type	Direction
L5	VSS	GND	
L51	PE3A_TX_DN[1]	PCIEX3	O
L53	PE1B_RX_DN[4]	PCIEX3	I
L55	PE2A_RX_DP[0]	PCIEX3	I
L57	PE1B_RX_DN[6]	PCIEX3	I
L7	DDR3_DQ[54]	SSTL	I/O
L9	DDR3_DQ[43]	SSTL	I/O
M10	DDR3_DQ[47]	SSTL	I/O
M12	DDR3_DQS_DN[14]	SSTL	I/O
M14	DDR3_DQ[45]	SSTL	I/O
M16	DDR3_ODT[5]	SSTL	O
M18	DDR2_MA_PAR	SSTL	O
M2	DDR3_DQ[63]	SSTL	I/O
M20	DDR3_CLK_DN[2]	SSTL	O
M22	DDR3_CLK_DP[3]	SSTL	O
M24	DDR3_CKE[1]	SSTL	O
M26	DDR3_DQ[31]	SSTL	I/O
M28	DDR3_DQ[26]	SSTL	I/O
M30	DDR3_DQS_DN[12]	SSTL	I/O
M32	DDR3_DQ[24]	SSTL	I/O
M34	VSS	GND	
M36	VSS	GND	
M38	DDR3_DQS_DP[10]	SSTL	I/O
M4	DDR3_DQS_DP[07]	SSTL	I/O
M40	DDR3_DQ[12]	SSTL	I/O
M42	VSS	GND	
M44	VSS	GND	
M46	VSS	GND	
M48	RSVD		
M50	VSS	GND	
M52	VSS	GND	
M54	PE1B_RX_DN[5]	PCIEX3	I
M56	PE1B_RX_DN[7]	PCIEX3	I
M6	DDR3_DQ[55]	SSTL	I/O
M8	VSS	GND	
N11	DDR3_DQS_DP[05]	SSTL	I/O
N13	VSS	GND	
N15	VCCD_23	PWR	
N17	VCCD_23	PWR	
N19	VCCD_23	PWR	
N21	VCCD_23	PWR	
N23	VCCD_23	PWR	

Table 8-2. Land Number (Sheet 44 of 48)

Land No.	Land Name	Buffer Type	Direction
N25	DDR3_CKE[3]	SSTL	O
N27	DDR3_DQ[30]	SSTL	I/O
N29	DDR3_DQS_DP[03]	SSTL	I/O
N3	DDR3_DQ[58]	SSTL	I/O
N31	DDR3_DQS_DP[12]	SSTL	I/O
N33	VSS	GND	
N35	VSS	GND	
N37	VSS	GND	
N39	DDR3_DQ[08]	SSTL	I/O
N41	VSS	GND	
N43	VSS	GND	
N45	VSA	PWR	
N47	VSS	GND	
N49	VSS	GND	
N5	VSS	GND	
N51	VSA	PWR	
N53	VSS	GND	
N55	PE2A_RX_DN[0]	PCIEX3	I
N7	DDR3_DQ[50]	SSTL	I/O
N9	VSS	GND	
P10	VSS	GND	
P12	VSS	GND	
P14	VSS	GND	
P16	DDR2_WE_N	SSTL	O
P18	DDR2_CS_N[5]	SSTL	O
P20	DDR2_MA[04]	SSTL	O
P22	DDR2_MA[07]	SSTL	O
P24	DDR2_BA[2]	SSTL	O
P26	VSS	GND	
P28	DDR3_DQS_DN[03]	SSTL	I/O
P30	VSS	GND	
P32	VSS	GND	
P34	DDR2_DQ[21]	SSTL	I/O
P36	DDR2_DQ[02]	SSTL	I/O
P38	VSS	GND	
P4	DDR3_DQ[59]	SSTL	I/O
P40	VSS	GND	
P42	DDR_VREFDQTX_C23	DC	O
P44	PE3D_TX_DN[15]	PCIEX3	O
P46	PE3C_TX_DP[8]	PCIEX3	O
P48	PE3A_TX_DP[3]	PCIEX3	O
P50	PE3B_TX_DP[6]	PCIEX3	O



Table 8-2. Land Number (Sheet 45 of 48)

Land No.	Land Name	Buffer Type	Direction
P52	PE3B_TX_DP[4]	PCIEX3	O
P54	VSS	GND	
P56	VSS	GND	
P6	DDR3_DQ[51]	SSTL	I/O
P8	VSS	GND	
R11	VSS	GND	
R13	DDR2_DQ[48]	SSTL	I/O
R15	DDR2_MA[13]	SSTL	O
R17	DDR2_BA[0]	SSTL	O
R19	DDR2_MA[01]	SSTL	O
R21	DDR2_MA[06]	SSTL	O
R23	DDR2_MA[09]	SSTL	O
R25	DDR3_CKE[4]	SSTL	O
R27	DDR3_CKE[5]	SSTL	O
R29	VSS	GND	
R3	VSS	GND	
R31	VSS	GND	
R33	DDR2_DQ[17]	SSTL	I/O
R35	VSS	GND	
R37	DDR2_DQ[06]	SSTL	I/O
R39	VSS	GND	
R41	DDR2_DQ[04]	SSTL	I/O
R43	DDR_SDA_C23	ODCMOS	I/O
R45	PE3C_TX_DP[10]	PCIEX3	O
R47	PE3A_TX_DP[2]	PCIEX3	O
R49	PE3B_TX_DP[7]	PCIEX3	O
R5	VSS	GND	
R51	PE3B_TX_DP[5]	PCIEX3	O
R53	PRDY_N	CMOS	O
R55	VSS	GND	
R7	VSS	GND	
R9	DDR2_DQ[54]	SSTL	I/O
T10	DDR2_DQ[50]	SSTL	I/O
T12	DDR2_DQS_DP[15]	SSTL	I/O
T14	DDR2_DQ[52]	SSTL	I/O
T16	DDR2_CAS_N	SSTL	O
T18	DDR2_MA[10]	SSTL	O
T20	DDR2_MA[03]	SSTL	O
T22	DDR2_MA[08]	SSTL	O
T24	DDR2_MA[12]	SSTL	O
T26	DDR2_CKE[1]	SSTL	O
T28	VSS	GND	

Table 8-2. Land Number (Sheet 46 of 48)

Land No.	Land Name	Buffer Type	Direction
T30	DDR2_DQ[23]	SSTL	I/O
T32	DDR2_DQS_DN[11]	SSTL	I/O
T34	DDR2_DQ[20]	SSTL	I/O
T36	DDR2_DQ[03]	SSTL	I/O
T38	DDR2_DQS_DN[00]	SSTL	I/O
T4	VSS	GND	
T40	DDR2_DQ[00]	SSTL	I/O
T42	VSS	GND	
T44	PE3D_TX_DP[15]	PCIEX3	O
T46	PE3C_TX_DN[8]	PCIEX3	O
T48	PE3A_TX_DN[3]	PCIEX3	O
T50	PE3B_TX_DN[6]	PCIEX3	O
T52	PE3B_TX_DN[4]	PCIEX3	O
T54	PE2A_RX_DP[1]	PCIEX3	I
T56	PE2A_RX_DP[2]	PCIEX3	I
T6	VSS	GND	
T8	VSS	GND	
U11	DDR2_DQS_DN[06]	SSTL	I/O
U13	DDR2_DQ[49]	SSTL	I/O
U15	DDR23_RCOMP[0]	Analog	I
U17	DDR2_RAS_N	SSTL	O
U19	DDR2_MA[02]	SSTL	O
U21	DDR2_MA[05]	SSTL	O
U23	DDR2_MA[11]	SSTL	O
U25	DDR2_MA[15]	SSTL	O
U27	DDR2_CKE[2]	SSTL	O
U29	DDR2_DQ[19]	SSTL	I/O
U3	DDR2_DQ[60]	SSTL	I/O
U31	DDR2_DQS_DP[02]	SSTL	I/O
U33	DDR2_DQ[16]	SSTL	I/O
U35	VSS	GND	
U37	DDR2_DQ[07]	SSTL	I/O
U39	DDR2_DQS_DP[09]	SSTL	I/O
U41	DDR2_DQ[05]	SSTL	I/O
U43	DDR_SCL_C23	ODCMOS	I/O
U45	PE3C_TX_DN[10]	PCIEX3	O
U47	PE3A_TX_DN[2]	PCIEX3	O
U49	PE3B_TX_DN[7]	PCIEX3	O
U5	VSS	GND	
U51	PE3B_TX_DN[5]	PCIEX3	O
U53	PREQ_N	CMOS	I/O
U55	PE2A_RX_DP[3]	PCIEX3	I



Table 8-2. Land Number (Sheet 47 of 48)

Land No.	Land Name	Buffer Type	Direction
U7	DDR2_DQ[44]	SSTL	I/O
U9	DDR2_DQ[55]	SSTL	I/O
V10	DDR2_DQ[51]	SSTL	I/O
V12	DDR2_DQS_DN[15]	SSTL	I/O
V14	DDR2_DQ[53]	SSTL	I/O
V16	VCCD_23	PWR	
V18	VCCD_23	PWR	
V20	VCCD_23	PWR	
V22	VCCD_23	PWR	
V24	VCCD_23	PWR	
V26	VSS	GND	
V28	VSS	GND	
V30	DDR2_DQ[22]	SSTL	I/O
V32	DDR2_DQS_DP[11]	SSTL	I/O
V34	VSS	GND	
V36	VSS	GND	
V38	DDR2_DQS_DP[00]	SSTL	I/O
V4	DDR2_DQ[61]	SSTL	I/O
V40	DDR2_DQ[01]	SSTL	I/O
V42	VSS	GND	
V44	VSS	GND	
V46	VSS	GND	
V48	VSS	GND	
V50	VSS	GND	
V52	TXT_PLTEN	CMOS	I
V54	PE2A_RX_DN[1]	PCIEX3	I
V56	PE2A_RX_DN[2]	PCIEX3	I
V6	DDR2_DQ[40]	SSTL	I/O
V8	VSS	GND	
W11	DDR2_DQS_DP[06]	SSTL	I/O
W13	VSS	GND	
W15	RSVD		
W17	DDR2_CS_N[8]	SSTL	O
W19	DDR2_ODT[1]	SSTL	O
W21	DDR2_CLK_DN[2]	SSTL	O
W23	DDR2_CLK_DN[3]	SSTL	O
W25	DDR2_MA[14]	SSTL	O
W27	DDR2_ECC[6]	SSTL	I/O
W29	DDR2_DQ[18]	SSTL	I/O
W3	DDR2_DQ[56]	SSTL	I/O
W31	DDR2_DQS_DN[02]	SSTL	I/O
W33	VSS	GND	

Table 8-2. Land Number (Sheet 48 of 48)

Land No.	Land Name	Buffer Type	Direction
W35	DDR2_DQ[29]	SSTL	I/O
W37	VSS	GND	
W39	DDR2_DQS_DN[09]	SSTL	I/O
W41	VSS	GND	
W43	VSS	GND	
W45	VSS	GND	
W47	VSS	GND	
W49	VTTA	PWR	
W5	VSS	GND	
W51	VSS	GND	
W53	VSS	GND	
W55	PE2A_RX_DN[3]	PCIEX3	I
W7	DDR2_DQ[45]	SSTL	I/O
W9	VSS	GND	
Y10	VSS	GND	
Y12	VSS	GND	
Y14	DDR23_RCOMP[2]	Analog	I
Y16	DDR2_CS_N[7]	SSTL	O
Y18	DDR2_ODT[3]	SSTL	O
Y20	DDR2_ODT[0]	SSTL	O
Y22	DDR2_CLK_DN[1]	SSTL	O
Y24	DDR2_CLK_DN[0]	SSTL	O
Y26	DDR2_ECC[2]	SSTL	I/O
Y28	VSS	GND	
Y30	VSS	GND	
Y32	VSS	GND	
Y34	DDR2_DQS_DP[12]	SSTL	I/O
Y36	VSS	GND	
Y38	VSS	GND	
Y4	DDR2_DQ[57]	SSTL	I/O
Y40	VSS	GND	
Y42	VSS	GND	
Y44	PE3D_TX_DP[13]	PCIEX3	O
Y46	PE3C_TX_DP[11]	PCIEX3	O
Y48	RSVD		
Y50	PE3B_RX_DP[4]	PCIEX3	I
Y52	PE3B_RX_DP[5]	PCIEX3	I
Y54	VTTA	PWR	
Y56	VSS	GND	
Y6	DDR2_DQ[41]	SSTL	I/O
Y8	DDR2_DQS_DP[14]	SSTL	I/O



§

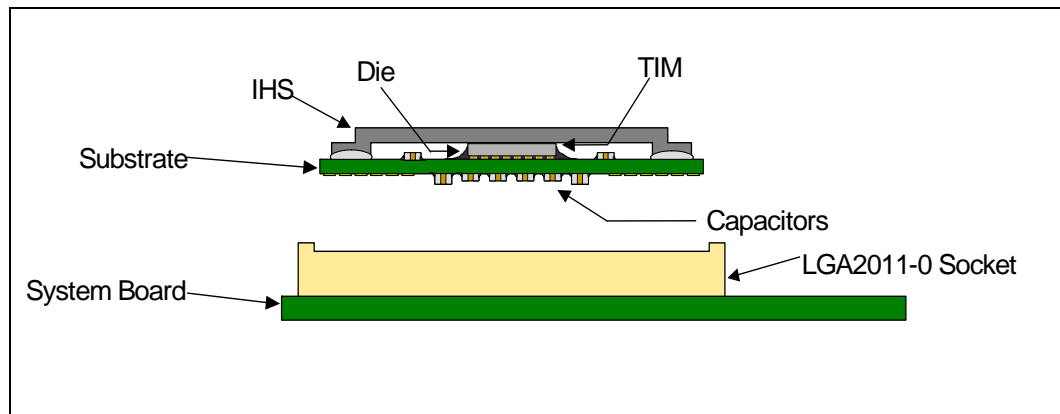
9 Package Mechanical Specifications

The processor is packaged in a Flip-Chip Land Grid Array (FCLGA10) package that interfaces with the baseboard via an LGA2011-0 land FCLGA10 socket. The package consists of a processor mounted on a substrate land-carrier. An integrated heat spreader (IHS) is attached to the package substrate and core and serves as the mating surface for processor component thermal solutions, such as a heatsink. [Figure 9-1](#) shows a sketch of the processor package components and how they are assembled together. Refer to the *Intel® Xeon® Processor E5-1600/E5-2600/E5-4600 Product Families Thermal/Mechanical Design Guide* for complete details on the LGA2011-0 land FCLGA10 socket.

The package components shown in [Figure 9-1](#) include the following:

1. Integrated Heat Spreader (IHS)
2. Thermal Interface Material (TIM)
3. Processor core (die)
4. Package substrate
5. Capacitors

Figure 9-1. Processor Package Assembly Sketch



Note:

1. Socket and baseboard are included for reference and are not part of processor package.

9.1 Package Mechanical Drawing

The package mechanical drawings are shown in [Figure 9-2](#) and [Figure 9-3](#). The drawings include dimensions necessary to design a thermal solution for the processor. These dimensions include:

1. Package reference with tolerances (total height, length, width, and so forth)
2. IHS parallelism and tilt
3. Land dimensions
4. Top-side and back-side component keep-out dimensions



5. Reference datums
6. All drawing dimensions are in millimeters (mm).
7. Guidelines on potential IHS flatness variation with socket load plate actuation and installation of the cooling solution is available in the *Intel® Xeon® Processor E5-1600/E5-2600/E5-4600 Product Families Thermal/Mechanical Design Guide*.

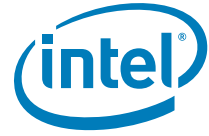


Figure 9-2. Processor Package Drawing Sheet 1 of 2

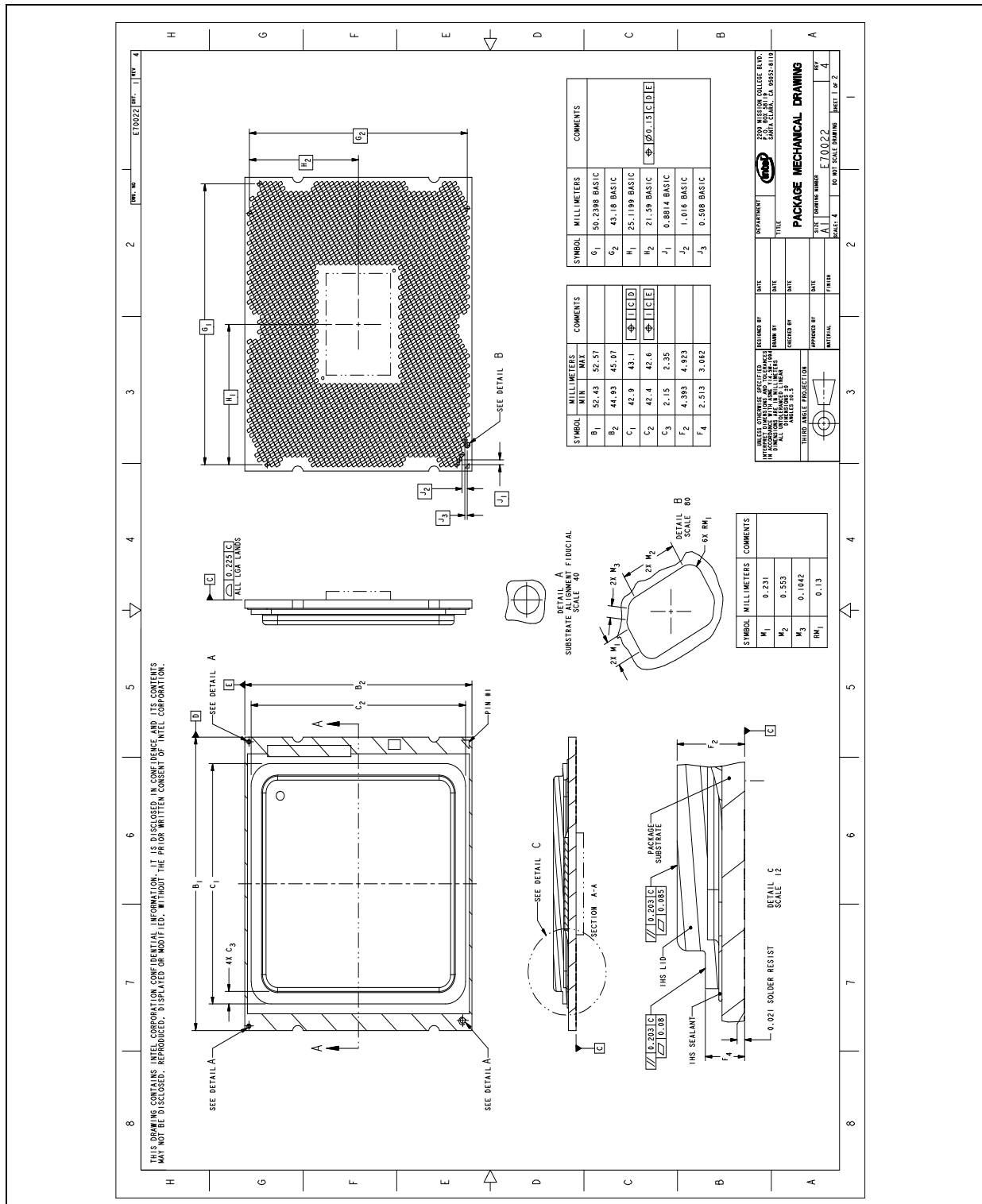
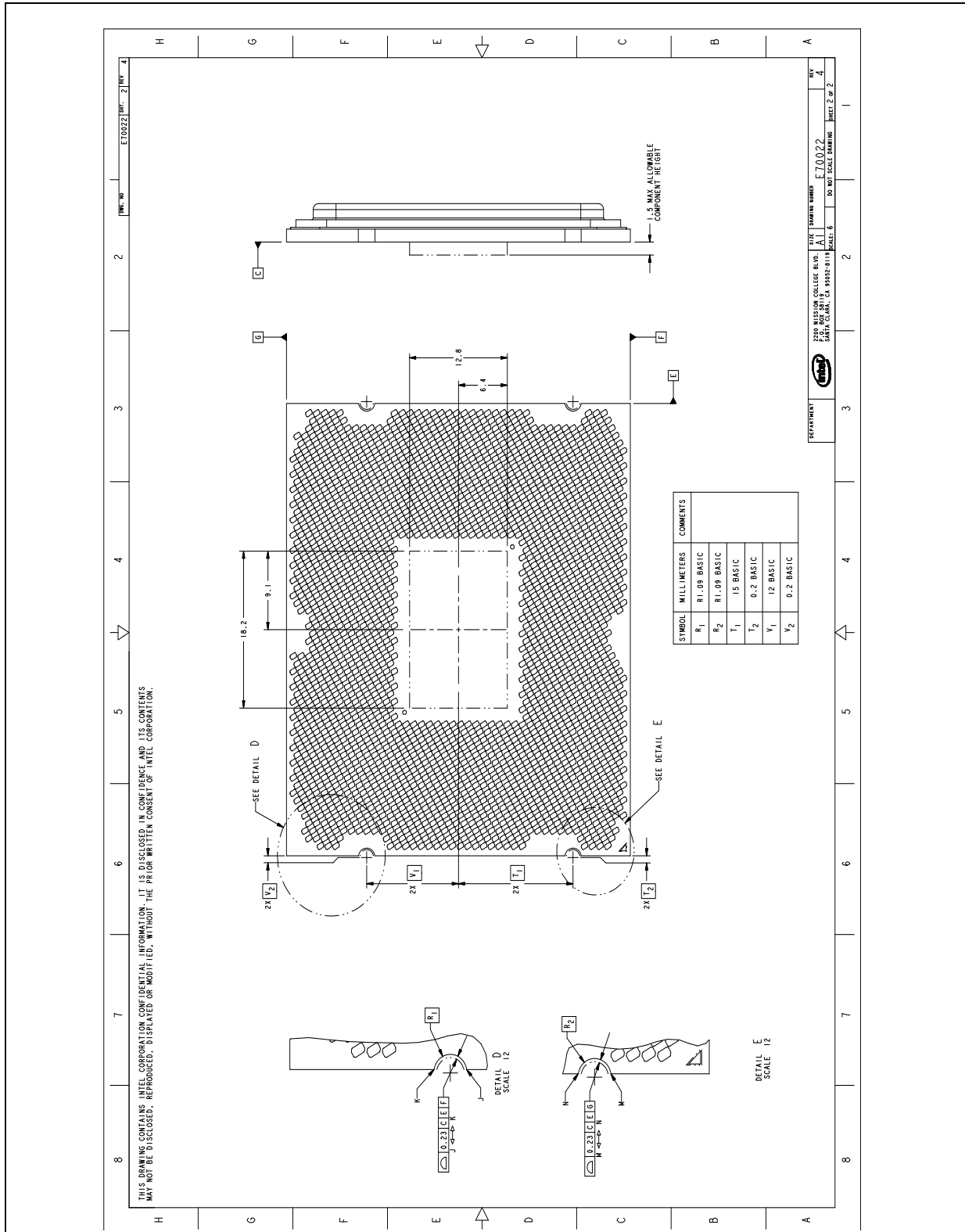


Figure 9-3. Processor Package Drawing Sheet 2 of 2





9.2 Processor Component Keep-Out Zones

The processor may contain components on the substrate that define component keep-out zone requirements. A thermal and mechanical solution design must not intrude into the required keep-out zones. Do not contact the Test Pad Area with conductive material. Decoupling capacitors are typically mounted to either the topside or land-side of the package substrate. See [Figure 9-2](#) and [Figure 9-3](#) for keep-out zones. The location and quantity of package capacitors may change due to manufacturing efficiencies but will remain within the component keep-in.

9.3 Package Loading Specifications

[Table 9-1](#) provides load specifications for the processor package. These maximum limits should not be exceeded during heatsink assembly, shipping conditions, or standard use condition. Exceeding these limits during test may result in component failure. The processor substrate should not be used as a mechanical reference or load-bearing surface for thermal solutions.

Table 9-1. Processor Loading Specifications

Parameter	Maximum	Notes
Static Compressive Load	890 N [200 lbf]	1, 2, 3, 5
Dynamic Load	540 N [121 lbf]	1, 3, 4, 5

Notes:

1. These specifications apply to uniform compressive loading in a direction normal to the processor IHS.
2. This is the maximum static force that can be applied by the heatsink and Independent Loading Mechanism (ILM).
3. These specifications are based on limited testing for design characterization. Loading limits are for the package constrained by the limits of the processor socket.
4. Dynamic loading is defined as an 11 ms duration average load superimposed on the static load requirement.
5. See *Intel® Xeon® Processor E5-1600/E5-2600/E5-4600 Product Families Thermal/Mechanical Design Guide* for minimum socket load to engage processor within socket.

9.4 Package Handling Guidelines

[Table 9-2](#) includes a list of guidelines on package handling in terms of recommended maximum loading on the processor IHS relative to a fixed substrate. These package handling loads may be experienced during heatsink removal.

Table 9-2. Package Handling Guidelines

Parameter	Maximum Recommended	Notes
Shear	80 lbs (36.287 kg)	
Tensile	35 lbs (15.875 kg)	
Torque	35 in.lbs (15.875 kg-cm)	

9.5 Package Insertion Specifications

The processor can be inserted into and removed from an LGA2011-0 land FCLGA10 socket 15 times. The socket should meet the LGA2011-0 land FCLGA10 requirements detailed in the *Intel® Xeon® Processor E5-1600/E5-2600/E5-4600 Product Families Thermal/Mechanical Design Guide*.

9.6 Processor Mass Specification

The typical mass of the processor is currently 45 grams. This mass [weight] includes all the components that are included in the package.

9.7 Processor Materials

Table 9-3 lists some of the package components and associated materials.

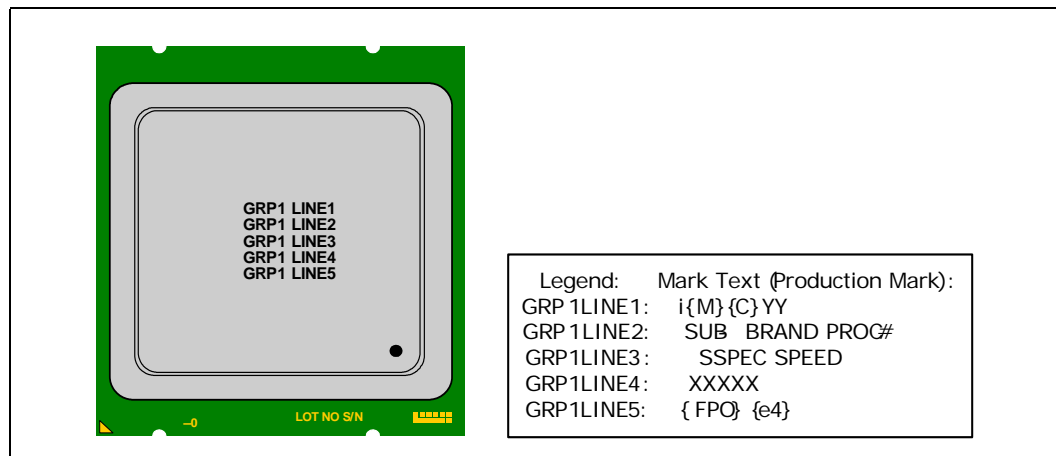
Table 9-3. Processor Materials

Component	Material
Integrated Heat Spreader (IHS)	Nickel Plated Copper
Substrate	Halogen Free, Fiber Reinforced Resin
Substrate Lands	Gold Plated Copper

9.8 Processor Markings

Figure 9-4 shows the topside markings on the processor. This diagram is to aid in the identification of the processor.

Figure 9-4. Processor Top-Side Markings



- Notes:
1. XXXXX = Country of Origin
 2. SPEED Format = X.XX GHz and no rounding

§



10 Boxed Processor Specifications

10.1 Introduction

Intel boxed processors are intended for system integrators who build systems from components available through distribution channels. The Intel® Xeon® processor E5-2600 product family (LGA2011-0 land FCLGA10) processors will be offered as Intel boxed processors, however the thermal solutions will be sold separately.

Boxed processors will not include a thermal solution in the box. Intel will offer boxed thermal solutions separately through the same distribution channels. Please reference [Section 10.1.1](#) - [Section 10.1.3](#) for a description of Boxed Processor thermal solutions.

10.1.1 Available Boxed Thermal Solution Configurations

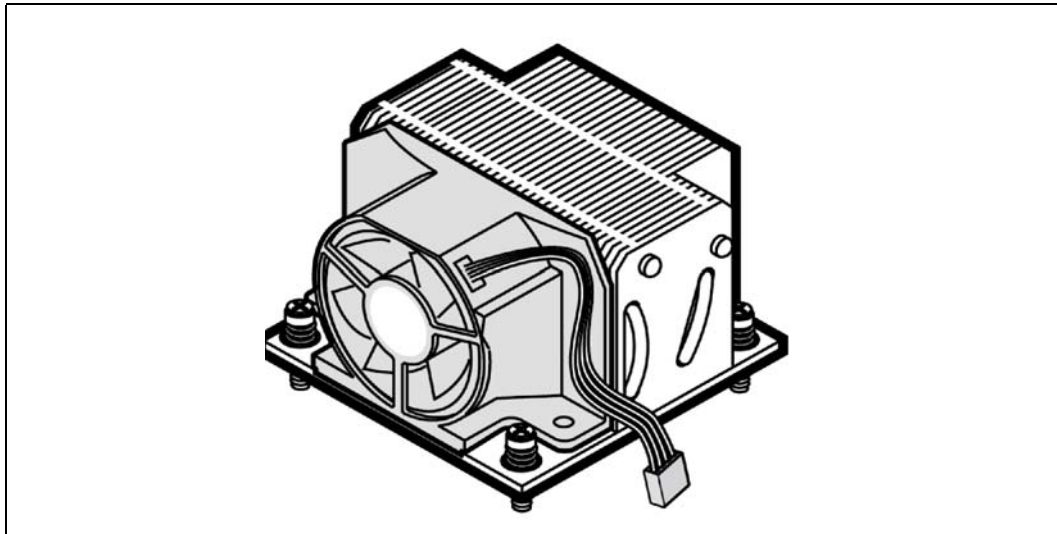
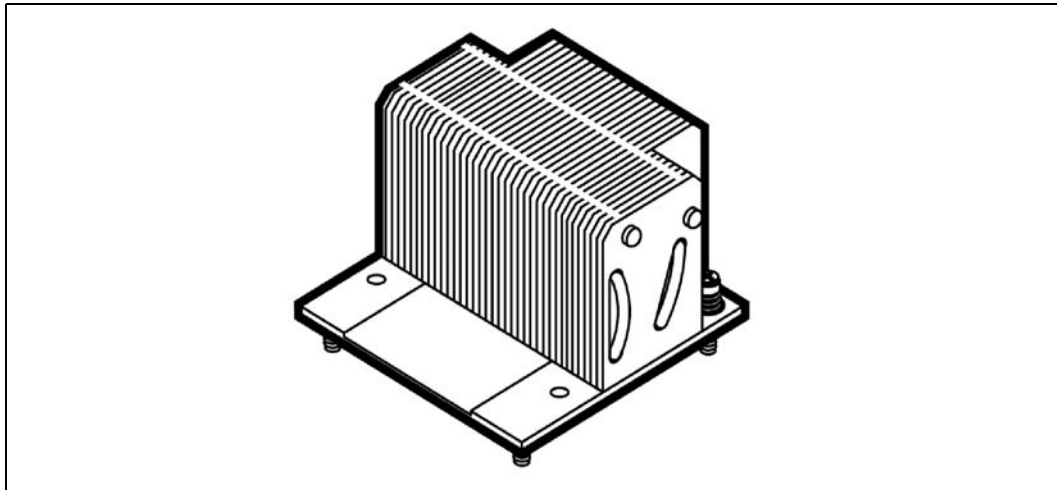
Intel will offer three different Boxed Heat Sink solutions to support LGA2011-0 land FCLGA10 Boxed Processors

- Boxed Intel® Thermal Solution STS200C (Order Code BXSTS200C): A Passive / Active Combination Heat Sink Solution that is intended for processors with a TDP up to 150W in a pedestal or 130W in 2U+ chassis with appropriate ducting.
- Boxed Intel® Thermal Solution STS200P (Order Code BXSTS200P): A 25.5 mm Tall Passive Heat Sink Solution that is intended for processors with a TDP of 130W or lower in 1U, or 2U chassis with appropriate ducting. Check with Blade manufacturer for compatibility.
- Boxed Intel® Thermal Solution STS200PNRW (Order Code BXSTS200PNRW): A 25.5 mm Tall Passive Heat Sink Solution that is intended for processors with a TDP of 130W or lower in 1U, or 2U chassis with appropriate ducting. Compatible with the narrow processor integrated load mechanism. Check with Blade manufacturer for compatibility.

10.1.2 Intel Thermal Solution STS200C (Passive/Active Combination Heat Sink Solution)

The STS200C, based on a 2U passive heat sink with a removable fan, is intended for use with processors with TDP's up to 150W in active configuration and 130W in passive configuration. This heat pipe-based solution is intended to be used as either a passive heat sink in a 2U or larger chassis, or as an active heat sink for pedestal chassis. [Figure 10-1](#) and [Figure 10-2](#) are representations of the heat sink solution. Although the active combination solution with the removable fan installed mechanically fits into a 2U keepout, its use has not been validated in that configuration.

The STS200C in the active fan configuration is primarily designed to be used in a pedestal chassis where sufficient air inlet space is present. The STS200C with the fan removed, as with any passive thermal solution, will require the use of chassis ducting and are targeted for use in rack mount or ducted pedestal servers. The retention solution used for these products is called ILM Retention System (ILM-RS).

Figure 10-1. STS200C Passive/Active Combination Heat Sink (with Removable Fan)

Figure 10-2. STS200C Passive/Active Combination Heat Sink (with Fan Removed)


The STS200C utilizes a fan capable of 4-pin pulse width modulated (PWM) control. Use of a 4-pin PWM controlled active thermal solution helps customers meet acoustic targets in pedestal platforms through the baseboard's ability to directly control the RPM of the processor heat sink fan. See [Section 10.3](#) for more details on fan speed control. Also see [Section 2.5, "Platform Environment Control Interface \(PECI\)"](#) for more on the PWM and PEFI interface along with Digital Thermal Sensors (DTS).

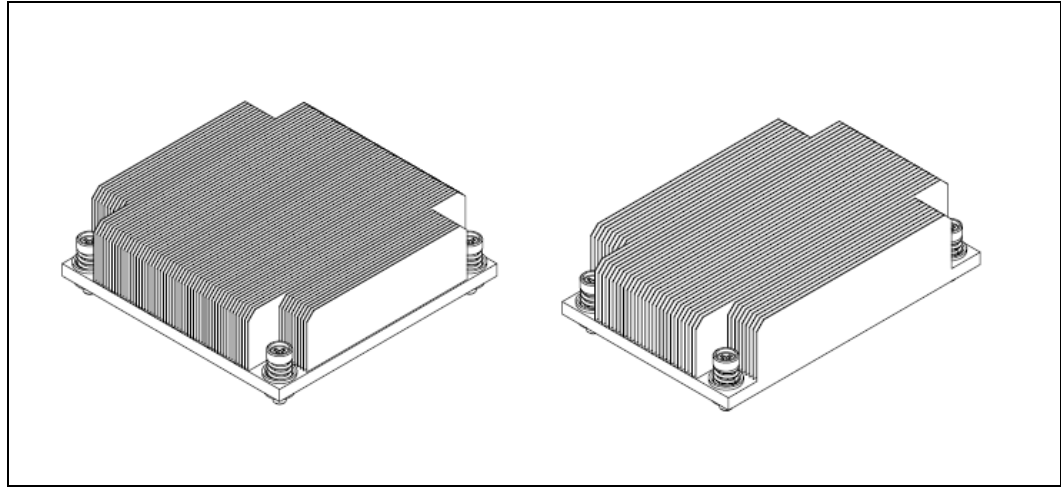
10.1.3 Intel Thermal Solution STS200P and STS200PNRW (Boxed 25.5 mm Tall Passive Heat Sink Solutions)

The STS200P and STS200PNRW are available for use with boxed processors that have TDP's of 130W and lower. These 25.5 mm Tall passive solutions are designed to be used in SSI Blades, 1U, and 2U chassis where ducting is present. The use of a 25.5 mm Tall heatsink in a 2U chassis is recommended to achieve a lower heatsink T_{LA} and more flexibility in system design optimization. [Figure 10-3](#) is a representation of the heat



sink solutions. The retention solution used for the STS200P Heat Sink Solution is called the ILM Retention System (ILM-RS). The retention solution used for the STS200PNRW Narrow Heat Sink Solution is called the Narrow ILM Retention System (Narrow ILM-RS).

Figure 10-3. STS200P and STS200PNRW 25.5 mm Tall Passive Heat Sinks



10.2 Mechanical Specifications

This section documents the mechanical specifications of the boxed processor solution.

10.2.1 Boxed Processor Heat Sink Dimensions and Baseboard Keepout Zones

The boxed processor and boxed thermal solutions will be sold separately. Clearance is required around the thermal solution to ensure unimpeded airflow for proper cooling. Baseboard keepout zones are [Figure 10-4](#) - [Figure 10-7](#). Physical space requirements and dimensions for the boxed processor and assembled heat sink are shown in [Figure 10-8](#) and [Figure 10-9](#). Mechanical drawings for the 4-pin fan header and 4-pin connector used for the active fan heat sink solution are represented in [Figure 10-10](#) and [Figure 10-11](#).

None of the heat sink solutions exceed a mass of 550 grams. Note that this is per processor, a dual processor system will have up to 1100 grams total mass in the heat sinks. See [Section 9.6](#) for details on the processor mass test.

Figure 10-4. Boxed Processor Motherboard Keepout Zones (1 of 4)

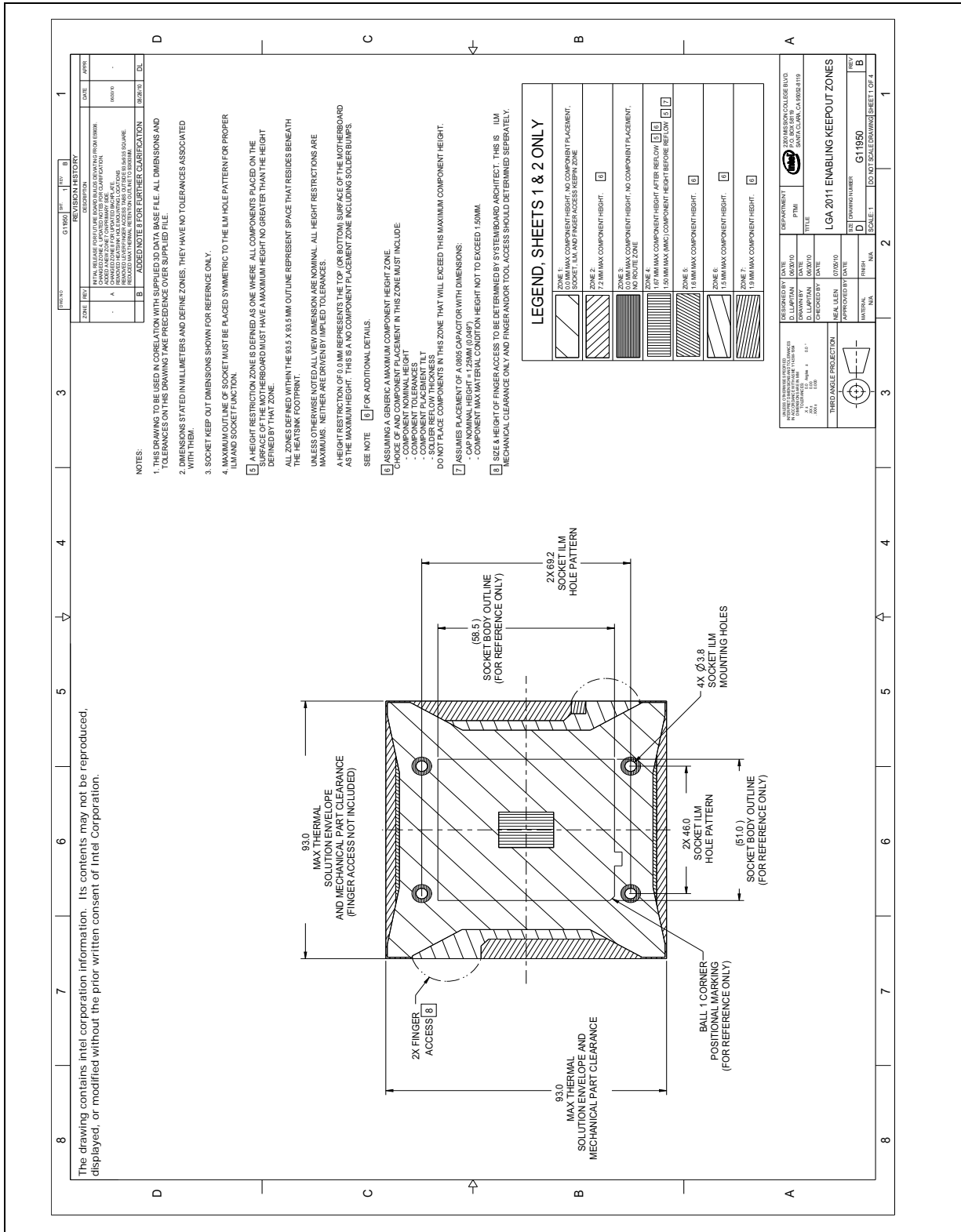




Figure 10-5. Boxed Processor Motherboard Keepout Zones (2 of 4)

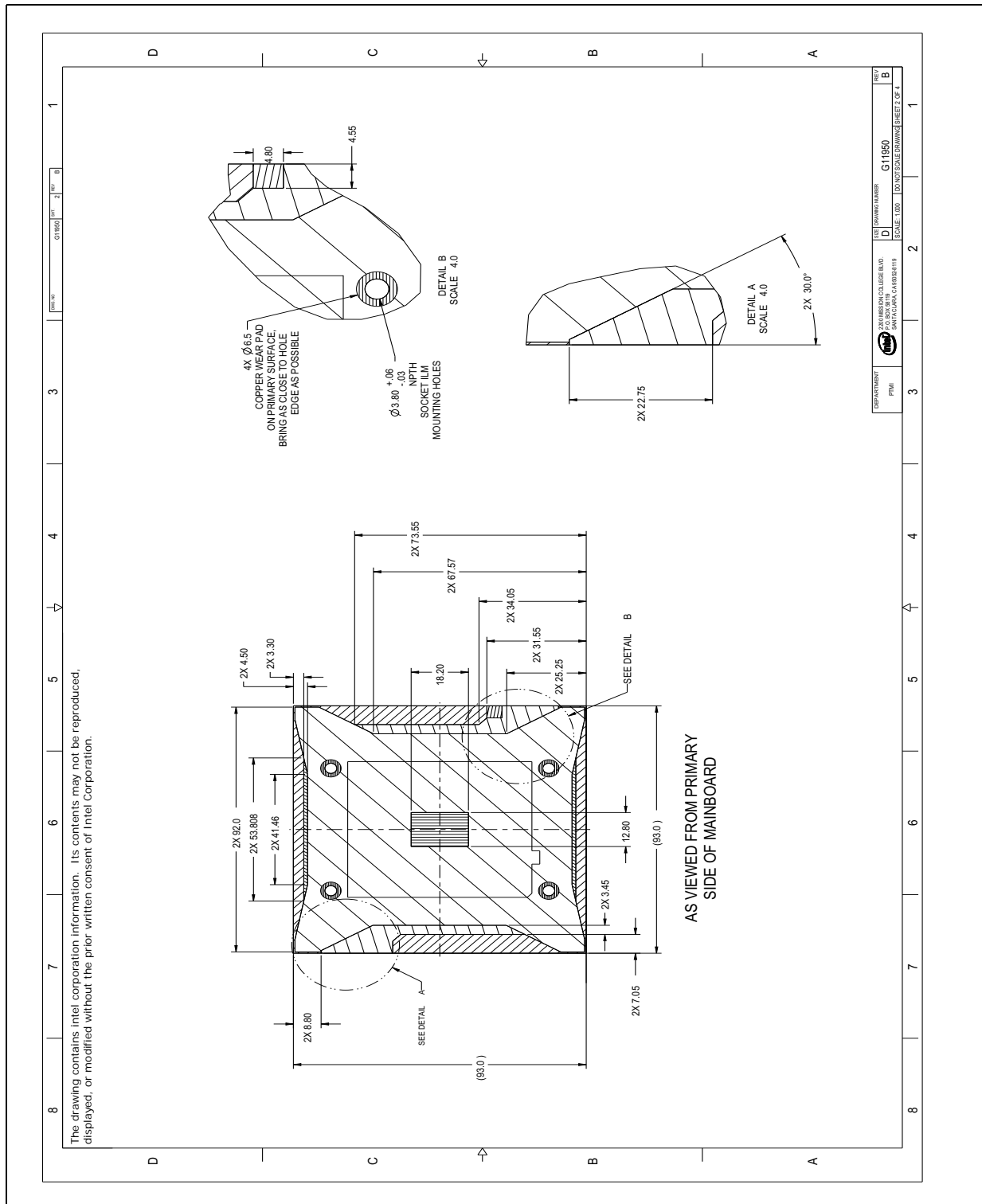


Figure 10-6. Boxed Processor Motherboard Keepout Zones (3 of 4)

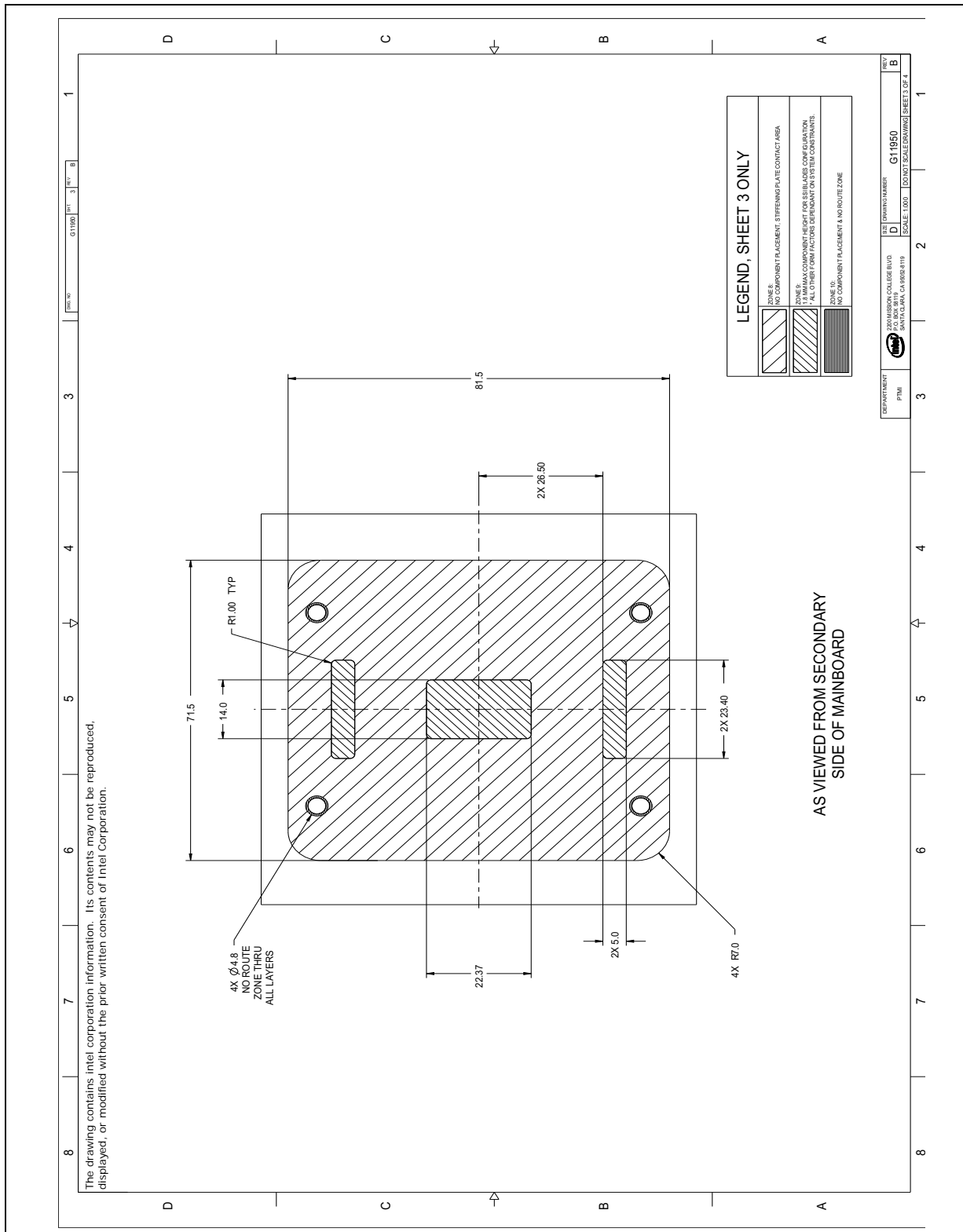




Figure 10-7. Boxed Processor Motherboard Keepout Zones (4 of 4)

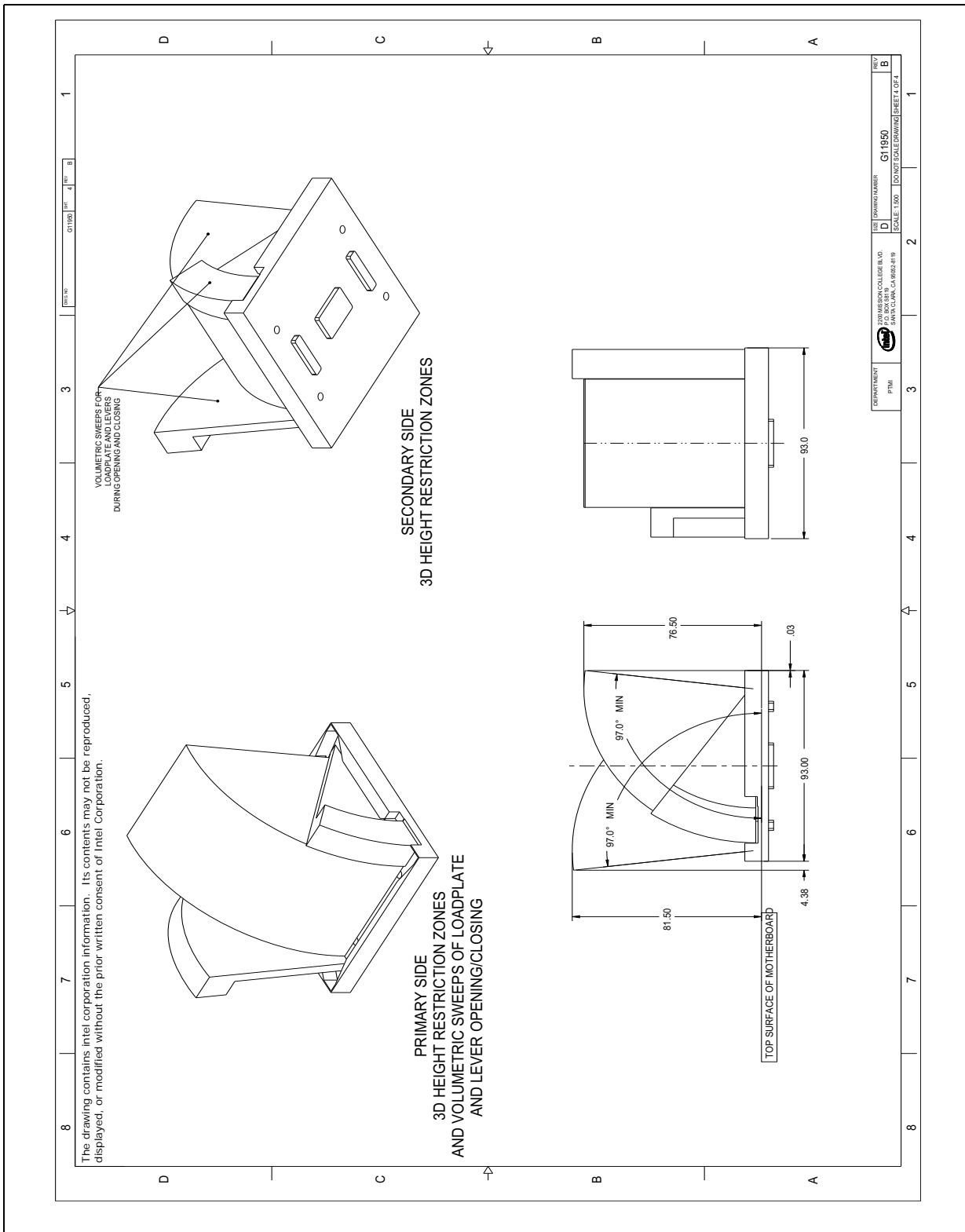
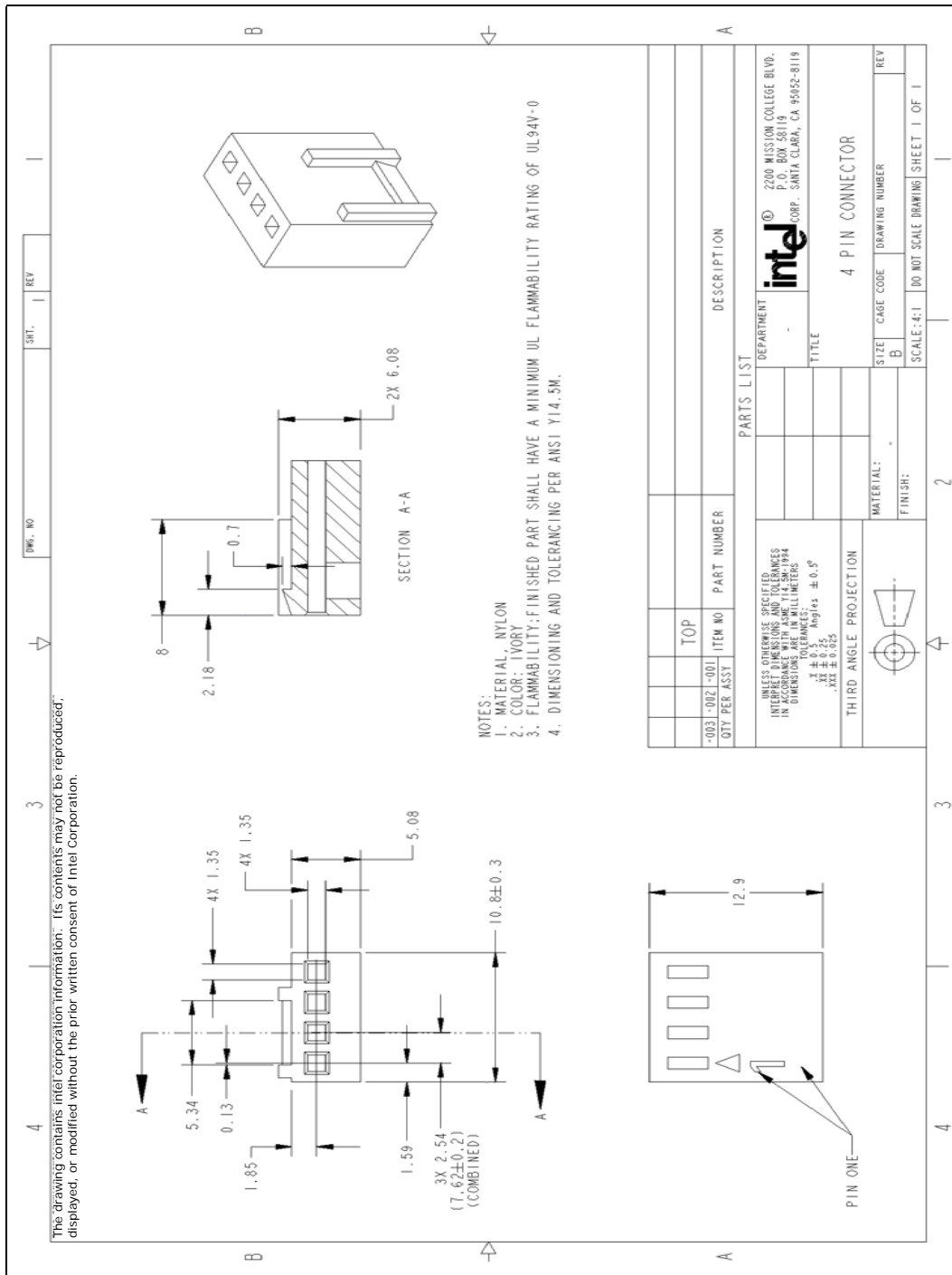


Figure 10-10.4-Pin Fan Cable Connector (For Active Heat Sink)



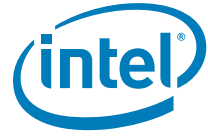
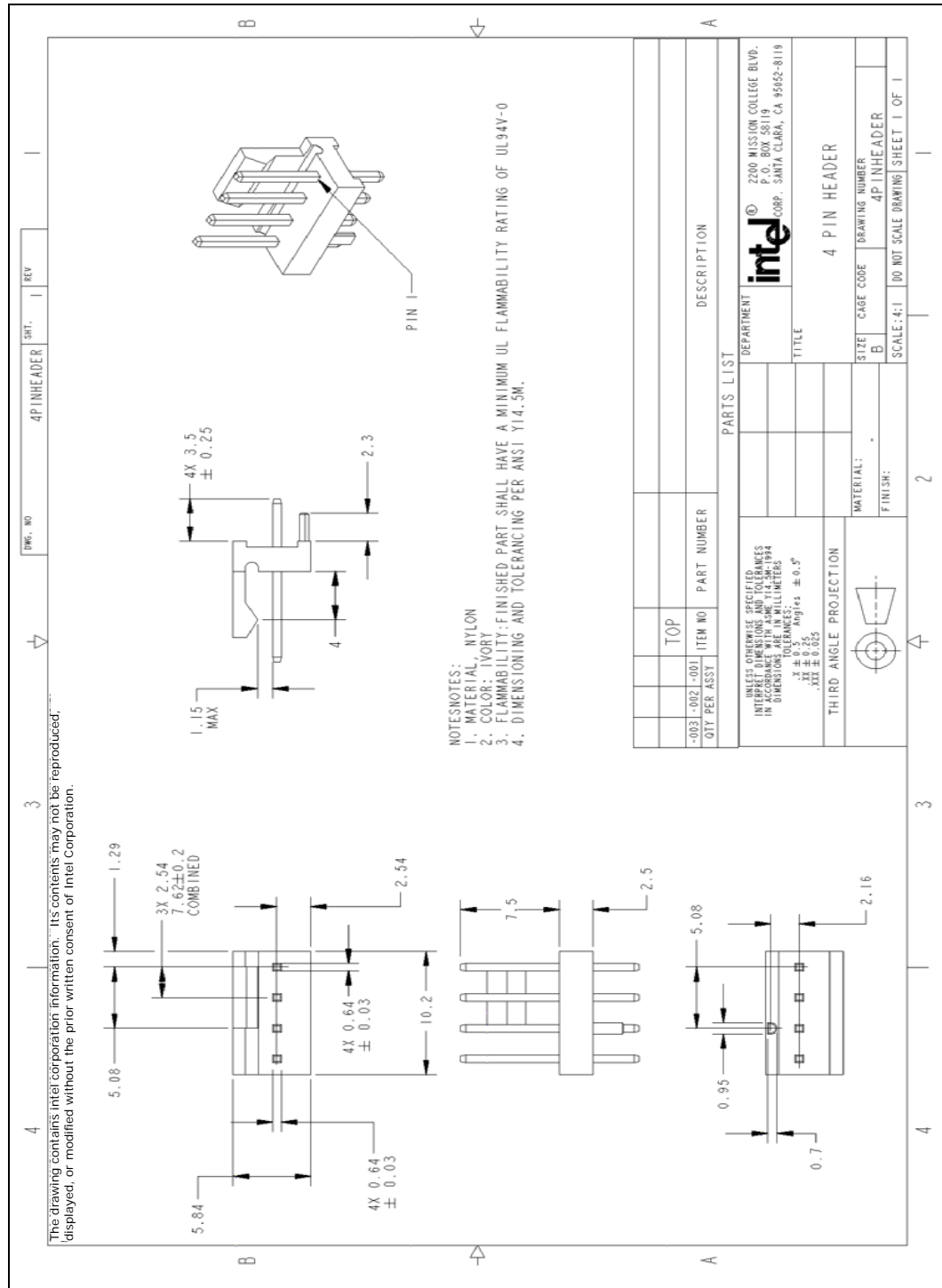


Figure 10-11. 4-Pin Base Baseboard Fan Header (For Active Heat Sink)





10.2.2 Boxed Processor Retention Mechanism and Heat Sink Support (ILM-RS)

Baseboards designed for use by a system integrator should include holes that are in proper alignment with each other to support the boxed processor.

The standard and narrow ILM-RSs are designed to extend air-cooling capability through the use of larger heat sinks with minimal airflow blockage and bypass. ILM-RS retention transfers load to the baseboard via the ILM Assembly. The ILM-RS spring, captive in the heatsink, provides the necessary compressive load for the thermal interface material. For specific design details on the standard and narrow ILM-RS and the Backplate please refer to the *Intel® Xeon® Processor E5-1600/E5-2600/E5-4600 Product Families Thermal/Mechanical Design Guide*.

All components of the ILM-RS heat sink solution will be captive to the heat sink and will only require a Phillips screwdriver to attach to the ILM Backplate Assembly. When installing the ILM-RS the screws should be tightened until they will no longer turn easily. This should represent approximately 8 inch-pounds of torque. More than that may damage the retention mechanism components.

10.3 Fan Power Supply [STS200C]

The 4-pin PWM controlled thermal solution is being offered to help provide better control over pedestal chassis acoustics. This is achieved through more accurate measurement of processor die temperature through the processor’s Digital Thermal Sensors. Fan RPM is modulated through the use of an ASIC located on the baseboard that sends out a PWM control signal to the 4th pin of the connector labeled as Control. This thermal solution requires a constant +12 V supplied to pin 2 of the active thermal solution and does not support variable voltage control or 3-pin PWM control. See [Figure 10-12](#) and [Table 10-1](#) for details on the 4-pin active heat sink solution connectors.

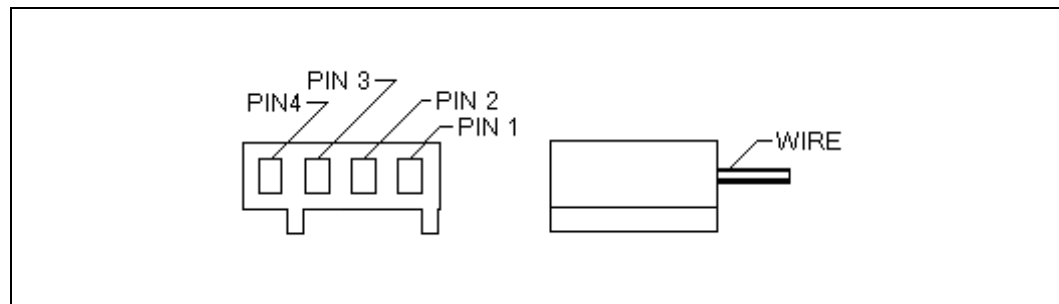
The fan power header on the baseboard must be positioned to allow the fan heat sink power cable to reach it. The fan power header identification and location must be documented in the suppliers platform documentation, or on the baseboard itself. The baseboard fan power header should be positioned within 177.8 mm [7 in.] from the center of the processor socket.

Table 10-1. PWM Fan Frequency Specifications For 4-Pin Active Thermal Solution

Description	Min Frequency	Nominal Frequency	Max Frequency	Unit
PWM Control Frequency Range	21,000	25,000	28,000	Hz



Figure 10-12. Fan Cable Connector Pin Out For 4-Pin Active Thermal Solution



10.3.1 Boxed Processor Cooling Requirements

As previously stated the boxed processor will have three thermal solutions available. Each configuration will require unique design considerations. Meeting the processor's temperature specifications is also the function of the thermal design of the entire system, and ultimately the responsibility of the system integrator. The processor temperature specifications are found in [Section 5, "Thermal Management Specifications"](#) of this document.

10.3.1.1 STS200C (Passive / Active Combination Heat Sink Solution)

The active configuration of the combination solution is designed to help pedestal chassis users to meet the thermal processor requirements without the use of processor chassis ducting. However, it is strongly recommended to implement some form of air duct to meet memory cooling and processor T_{LA} temperature requirements. Use of the active configuration in a 2U rackmount chassis is not recommended.

In the passive configuration it is assumed that a chassis duct will be implemented.

For a list processor and thermal solution boundary conditions, such as $P_{si_{ca}}$, T_{LA} , airflow, flow impedance, etc, see [Table 10-2](#) and [Table 10-3](#). It is recommended that the ambient air temperature outside of the chassis be kept at or below 35 °C. Meeting the processor's temperature specification is the responsibility of the system integrator. This thermal solution is for use with processor SKUs no higher than 150W (8 Core) or 130W (4 and 6 core).

10.3.1.2 STS200P and STS200PNRW (25.5mm Tall Passive Heat Sink Solution) (Blade + 1U + 2U Rack)

These passive solutions are intended for use in SSI Blade, 1U or 2U rack configurations. It is assumed that a chassis duct will be implemented in all configurations.

For a list processor and thermal solution boundary conditions, such as $P_{si_{ca}}$, T_{LA} , airflow, flow impedance, etc, see [Table 10-2](#) and [Table 10-3](#). It is recommended that the ambient air temperature outside of the chassis be kept at or below 35 °C. Meeting the processor's temperature specification is the responsibility of the system integrator.

These thermal solutions are for use with processor SKUs no higher than 130W (6 and 8 Core), or 80W (4 Core).

Note: Please refer to the *Intel® Xeon® Processor E5-1600/E5-2600/E5-4600 Product Families Thermal/Mechanical Design Guide* for detailed mechanical drawings of the STS200P and STS200PNRW.



Table 10-2. 8 Core / 6 Core Server Thermal Solution Boundary Conditions

TDP	Thermal Solution	Ψ_{CA}^2 (°C/W)	T_{LA}^1 (°C)	Airflow ³ (CFM)	Delta P (inch of H ₂ O)	Heatsink Volumetric ⁴ (mm)
150W (WS Only) 8 Core	STS200C (with fan)	0.180	40.0	Max RPM	N/A	91.5x91.5x64
130W (1U) 6 and 8 Core	STS200P	0.242	53.6	16	0.406	91.5x91.5x25.5
130W (1U) 6 and 8 Core	STS200PNRW	0.253	52.2	14	0.347	70x106x25.5
130W (2U) 6 and 8 Core	STS200C (without fan)	0.180	61.6	26	0.14	91.5x91.5x64
130W (Pedestal) 6 and 8 Core	STS200C (with fan)	0.180	61.6	Max RPM	N/A	91.5x91.5x64
115W (Pedestal) 8 Core	STS200P	0.241	52.2	16	0.406	91.5x91.5x25.5
115W (Pedestal) 8 Core	STS200PNRW	0.252	51.0	14	0.347	70x106x25.5
115W (Pedestal) 8 Core	STS200C (with fan)	0.179	59.4	Max RPM	N/A	91.5x91.5x64
95W (1U) 6 and 8 Core	STS200P	0.243	49.9	16	0.406	91.5x91.5x25.5
95W (1U) 6 and 8 Core	STS200PNRW	0.254	48.9	14	0.347	70x106x25.5
95W (Pedestal) 6 and 8 Core	STS200C (with fan)	0.181	55.8	Max RPM	N/A	91.5x91.5x64
70W(1U) 8 Core	STS200P	0.239	47.2	16	0.406	91.5x91.5x25.5
70W(1U) 8 Core	STS200PNRW	0.250	46.5	14	0.347	70x106x25.5
70W (Pedestal) 8 Core	STS200C (with fan)	0.177	51.6	Max RPM	N/A	91.5x91.5x64
60W(1U) 8 Core	STS200P	0.239	45.7	16	0.406	91.5x91.5x25.5
60W(1U) 8 Core	STS200PNRW	0.250	45.0	14	0.347	70x106x25.5
60W(Pedestal) 8 Core	STS200C (with fan)	0.177	49.4	Max RPM	N/A	91.5x91.5x64

Table 10-3. 4 Core Server Thermal Solution Boundary Conditions

TDP	Thermal Solution	Ψ_{CA}^2 (°C/W)	T_{LA}^1 (°C)	Airflow ³ (CFM) (inch of H ₂ O)	Delta P	Heatsink Volumetric ⁴ (mm)
130W (Pedestal)	STS200C (with fan)	0.199	47.1	Max RPM	N/A	91.5x91.5x64
80W- 1U)	STS200P	0.261	49.1	16	0.406	91.5x91.5x25.5
80W- 1U)	STS200PNRW	0.272	48.2	14	0.347	70x106x25.5

Notes:

1. Local ambient temperature of the air entering the heatsink or fan. System ambient and altitude are assumed 35°C and sea level.
2. Max target (mean + 3 sigma) for thermal characterization parameter.
3. Airflow through the heatsink fins with zero bypass. Max target for pressure drop (dP) measured in inches H2O.
4. See Table 10-2 and Table 10-3 for detailed dimensions. Dimensions of heatsinks do not include socket or processor.

10.4 Boxed Processor Contents

The Boxed Processor and Boxed Thermal Solution contents are outlined below.



Boxed Processor

- Intel® Xeon® processor E5-2600 product family
- Installation and warranty manual
- Intel Inside Logo

Boxed Thermal Solution

- Thermal solution assembly
- Thermal interface material (pre-applied)
- Installation and warranty manual

§



Mouser Electronics

Authorized Distributor

Click to View Pricing, Inventory, Delivery & Lifecycle Information:

[Intel:](#)

[CM8063501293200S R1A0](#) [CM8063501293506S R1A2](#) [HH80556JH0464MS LAG3](#)

Компания «Life Electronics» занимается поставками электронных компонентов импортного и отечественного производства от производителей и со складов крупных дистрибьюторов Европы, Америки и Азии.

С конца 2013 года компания активно расширяет линейку поставок компонентов по направлению коаксиальный кабель, кварцевые генераторы и конденсаторы (керамические, пленочные, электролитические), за счёт заключения дистрибьюторских договоров

Мы предлагаем:

- Конкурентоспособные цены и скидки постоянным клиентам.
- Специальные условия для постоянных клиентов.
- Подбор аналогов.
- Поставку компонентов в любых объемах, удовлетворяющих вашим потребностям.
- Приемлемые сроки поставки, возможна ускоренная поставка.
- Доставку товара в любую точку России и стран СНГ.
- Комплексную поставку.
- Работу по проектам и поставку образцов.
- Формирование склада под заказчика.
- Сертификаты соответствия на поставляемую продукцию (по желанию клиента).
- Тестирование поставляемой продукции.
- Поставку компонентов, требующих военную и космическую приемку.
- Входной контроль качества.
- Наличие сертификата ISO.

В составе нашей компании организован Конструкторский отдел, призванный помогать разработчикам, и инженерам.

Конструкторский отдел помогает осуществить:

- Регистрацию проекта у производителя компонентов.
- Техническую поддержку проекта.
- Защиту от снятия компонента с производства.
- Оценку стоимости проекта по компонентам.
- Изготовление тестовой платы монтаж и пусконаладочные работы.



Тел: +7 (812) 336 43 04 (многоканальный)

Email: org@lifeelectronics.ru