

# Series 01

**Characteristics**

The compact 16mm Series 01 is especially suited for:

- Raised design

This series is ideally suited for combined use with Series 51.

**Functions**

The Series 01 incorporates the following functions:

- Indicator
- Pushbutton
- Illuminated pushbutton

**Market segments**

The EAO Series 01 is especially suited for applications in the segments:

- Machinery and Automation
- Panel building

Please refer to the EAO website to obtain detailed information regarding this series [www.products.eao.com](http://www.products.eao.com)  
Configure a product to your exact needs and request a quotation.





<b>Overview</b>		<b>01</b>
<b>Raised design</b>		<b>02</b>
Indicator	4	
Illuminated pushbutton	6	<b>03</b>
<b>Accessoires</b>	<b>10</b>	<b>04</b>
<b>Drawings</b>	<b>22</b>	<b>10</b>
<b>Technical data</b>	<b>23</b>	<b>14</b>
<b>Marking</b>	<b>25</b>	<b>17</b>
<b>Guidelines for use</b>	<b>26</b>	<b>18</b>
<b>Index</b>	<b>28</b>	<b>19</b>

01
02
03
04
10
14
17
18
19
22
31
41
44
51
56
57
61
70
71
82
84
92
95
96
97
99
ST

# 01 Raised design

## Indicator, IP 40



Product can differ from the current configuration.



Dimensions [mm]  
 H = Universal terminal 2.0 x 0.5 mm,  
 L = Solder terminal,  
 L1 = Solder terminal 2.8 x 0.5 mm

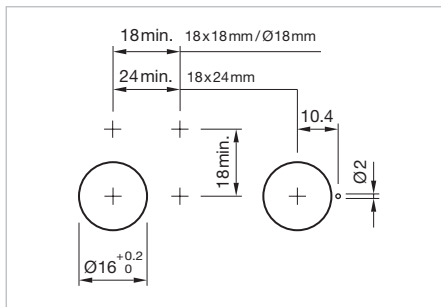

Mounting cut-outs [mm]

### Equipment consisting of (schematic overview)

	<b>Lens</b>	<i>page 10</i>
	<b>Single-LED</b>	<i>page 17</i>
	<b>Actuator</b>	
	<b>Fixing nut</b>	

Each Part Number listed below includes all the black components shown in the 3D-drawing.

*To obtain a complete unit, please select the red components from the pages shown.*

Diode 1N4007	Terminal	Part No.	Component layout	Wiring diagram	Weight
	<b>Indicator actuator, Front dimension 18 x 18 mm</b>				
1	Universal 2.0 x 0.5 mm	<b>01-703.006</b>	4	1	0.008 kg
2	Universal 2.0 x 0.5 mm	<b>01-704.006</b>	4	2	0.008 kg
	Solder 2.8 x 0.5 mm	<b>01-050.002</b>		3	0.006 kg
	Solder	<b>01-050.005</b>		3	0.006 kg
	Universal 2.0 x 0.5 mm	<b>01-051.006</b>	4	3	0.006 kg
	<b>Indicator actuator, Front dimension 18 x 24 mm</b>				
1	Universal 2.0 x 0.5 mm	<b>01-701.006</b>	4	1	0.008 kg
2	Universal 2.0 x 0.5 mm	<b>01-702.006</b>	4	2	0.008 kg
	Solder 2.8 x 0.5 mm	<b>01-040.002</b>		3	0.006 kg
	Solder	<b>01-040.005</b>		3	0.006 kg
	Universal 2.0 x 0.5 mm	<b>01-041.006</b>	4	3	0.006 kg

Diode 1N4007		Terminal	Part No.	Component layout	Wiring diagram	Weight
 <p><b>Indicator actuator, Front dimension Ø 18 mm</b></p>						
1	Universal 2.0 x 0.5 mm	<b>01-741.006</b>	4	1	0.008 kg	
2	Universal 2.0 x 0.5 mm	<b>01-742.006</b>	4	2	0.008 kg	
	Solder 2.8 x 0.5 mm	<b>01-030.002</b>		3	0.006 kg	
	Solder	<b>01-030.005</b>		3	0.006 kg	
	Universal 2.0 x 0.5 mm	<b>01-031.006</b>	4	3	0.006 kg	

The component layouts you will find from page 22



01  
02  
03  
04  
10  
14  
17  
18  
19  
22  
31  
41  
44  
51  
56  
57  
61  
70  
71  
82  
84  
92  
95  
96  
97  
99  
ST

# 01 Raised design

## Illuminated pushbutton, IP 40



Product can differ from the current configuration.



Dimensions [mm]  
 H = Universal terminal 2.0 x 0.5 mm,  
 H1 = Universal-Solder terminal,  
 L = Solder terminal,  
 L1 = Solder terminal 2.8 x 0.5 mm

### Equipment consisting of (schematic overview)

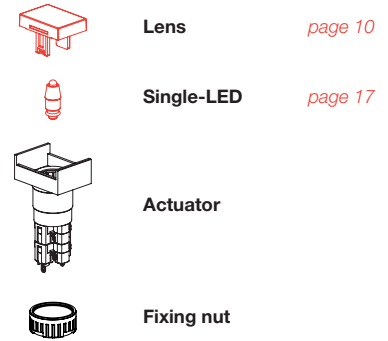

Each Part Number listed below includes all the black components shown in the 3D-drawing.

To obtain a complete unit, please select the red components from the pages shown.

### Additional Information

- Material of contact Gold

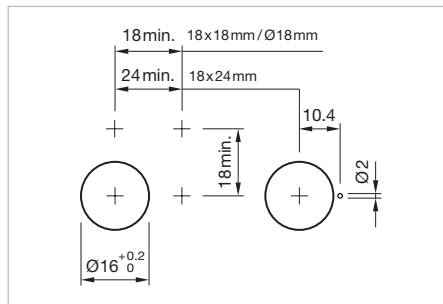

Mounting cut-outs [mm]

Switching system	Contacts	Diode 1N4007	Switching action	Terminal	Part No.	Component layout	Wiring diagram	Weight		
 <b>Illuminated pushbutton actuator, Front dimension 18 x 18 mm</b>	Low-level element		B	Universal 2.0 x 0.5 mm	<b>01-456.036</b>	4	1	0.009 kg		
			C	Universal 2.0 x 0.5 mm	<b>01-486.036</b>	4	2	0.009 kg		
		1 NC + 1 NO		B	Universal 2.0 x 0.5 mm	<b>01-453.036</b>	4	3	0.009 kg	
				C	Universal 2.0 x 0.5 mm	<b>01-483.036</b>	4	4	0.009 kg	
		1 NO		B	Universal 2.0 x 0.5 mm	<b>01-455.036</b>	4	5	0.009 kg	
				C	Universal 2.0 x 0.5 mm	<b>01-485.036</b>	4	6	0.009 kg	
		2 NC		B	Universal 2.0 x 0.5 mm	<b>01-452.036</b>	4	7	0.009 kg	
				C	Universal 2.0 x 0.5 mm	<b>01-482.036</b>	4	8	0.009 kg	
		2 NO		B	Universal 2.0 x 0.5 mm	<b>01-451.036</b>	4	9	0.009 kg	
				C	Universal 2.0 x 0.5 mm	<b>01-481.036</b>	4	10	0.009 kg	
Snap-action switching element	1 NC + 1 NO	1	B	Universal-Solder	<b>01-709.0292</b>	4	11	0.010 kg		
			C	Universal-Solder	<b>01-717.0292</b>	4	12	0.010 kg		
		2	B	Universal-Solder	<b>01-710.0292</b>	4	13	0.010 kg		
			C	Universal-Solder	<b>01-718.0292</b>	4	14	0.010 kg		
			B	Solder	<b>01-151.0252</b>		15	0.008 kg		
			B	Solder 2.8 x 0.5 mm	<b>01-151.022</b>		16	0.008 kg		
			C	Solder	<b>01-281.0252</b>		17	0.008 kg		
			C	Solder 2.8 x 0.5 mm	<b>01-281.022</b>		18	0.008 kg		
			2 NC + 2 NO	1	B	Universal-Solder	<b>01-711.0292</b>	4	19	0.012 kg
					C	Universal-Solder	<b>01-719.0292</b>	4	20	0.012 kg

Switching system	Contacts	Diode 1N4007	Switching action	Terminal	Part No.	Component layout	Wiring diagram	Weight
Snap-action switching element	2 Ö + 2 S	2	B	Universal-Solder	<b>01-712.0292</b>	4	21	0.012 kg
			C	Universal-Solder	<b>01-720.0292</b>	4	22	0.012 kg
		1	B	Solder	<b>01-152.0252</b>		23	0.010 kg
			C	Solder	<b>01-282.0252</b>		24	0.010 kg
	3 NC + 3 NO		B	Solder	<b>01-153.0252</b>		25	0.012 kg
			C	Solder	<b>01-283.0252</b>		26	0.012 kg
	4 NC + 4 NO		B	Solder	<b>01-154.0252</b>		27	0.014 kg
			C	Solder	<b>01-284.0252</b>		28	0.014 kg



**Illuminated pushbutton actuator, Front dimension 18 x 24 mm**

Low-level element	1 NC		B	Universal 2.0 x 0.5 mm	<b>01-426.036</b>	4	1	0.009 kg	
			C	Universal 2.0 x 0.5 mm	<b>01-466.036</b>	4	2	0.009 kg	
	1 NC + 1 NO		B	Universal 2.0 x 0.5 mm	<b>01-423.036</b>	4	3	0.009 kg	
			C	Universal 2.0 x 0.5 mm	<b>01-463.036</b>	4	4	0.009 kg	
	1 NO		B	Universal 2.0 x 0.5 mm	<b>01-425.036</b>	4	5	0.009 kg	
			C	Universal 2.0 x 0.5 mm	<b>01-465.036</b>	4	6	0.009 kg	
	2 NC		B	Universal 2.0 x 0.5 mm	<b>01-422.036</b>	4	7	0.009 kg	
			C	Universal 2.0 x 0.5 mm	<b>01-462.036</b>	4	8	0.009 kg	
	2 NO		B	Universal 2.0 x 0.5 mm	<b>01-421.036</b>	4	9	0.009 kg	
			C	Universal 2.0 x 0.5 mm	<b>01-461.036</b>	4	10	0.009 kg	
	Snap-action switching element	1 NC + 1 NO	1	B	Universal-Solder	<b>01-705.0292</b>	4	11	0.010 kg
				C	Universal-Solder	<b>01-713.0292</b>	4	12	0.010 kg
2				B	Universal-Solder	<b>01-706.0292</b>	4	13	0.010 kg
				C	Universal-Solder	<b>01-714.0292</b>	4	14	0.010 kg
			B	Solder	<b>01-121.0252</b>		15	0.008 kg	
			B	Solder 2.8 x 0.5 mm	<b>01-121.022</b>		16	0.008 kg	
			C	Solder	<b>01-261.0252</b>		17	0.008 kg	
			C	Solder 2.8 x 0.5 mm	<b>01-261.022</b>		18	0.008 kg	
2 NC + 2 NO		1	B	Universal-Solder	<b>01-707.0292</b>	4	19	0.012 kg	
			C	Universal-Solder	<b>01-715.0292</b>	4	20	0.012 kg	
		2	B	Universal-Solder	<b>01-708.0292</b>	4	21	0.012 kg	
			1	C	Universal-Solder	<b>01-716.0292</b>	4	22	0.012 kg
				B	Solder	<b>01-122.0252</b>		23	0.010 kg
			C	Solder	<b>01-262.0252</b>		24	0.010 kg	
3 NC + 3 NO			B	Solder	<b>01-123.0252</b>		25	0.012 kg	
			C	Solder	<b>01-263.0252</b>		26	0.012 kg	
4 NC + 4 NO			B	Solder	<b>01-124.0252</b>		27	0.014 kg	
			C	Solder	<b>01-264.0252</b>		28	0.014 kg	

01  
02  
03  
04  
10  
14  
17  
18  
19  
22  
31  
41  
44  
51  
56  
57  
61  
70  
71  
82  
84  
92  
95  
96  
97  
99  
ST

# 01 Raised design

Switching system	Contacts	Diode 1N4007	Switching action	Terminal	Part No.	Component layout	Wiring diagram	Weight	
 <p><b>Illuminated pushbutton actuator, Front dimension Ø 18 mm</b></p>									
Low-level element	1 NC		B	Universal 2.0 x 0.5 mm	<b>01-436.036</b>	4	1	0.009 kg	
			C	Universal 2.0 x 0.5 mm	<b>01-476.036</b>	4	2	0.009 kg	
	1 NC + 1 NO		B	Universal 2.0 x 0.5 mm	<b>01-433.036</b>	4	3	0.009 kg	
			C	Universal 2.0 x 0.5 mm	<b>01-473.036</b>	4	4	0.009 kg	
	1 NO		B	Universal 2.0 x 0.5 mm	<b>01-435.036</b>	4	5	0.009 kg	
			C	Universal 2.0 x 0.5 mm	<b>01-475.036</b>	4	6	0.009 kg	
	2 NC		B	Universal 2.0 x 0.5 mm	<b>01-432.036</b>	4	7	0.009 kg	
			C	Universal 2.0 x 0.5 mm	<b>01-472.036</b>	4	8	0.009 kg	
	2 NO		B	Universal 2.0 x 0.5 mm	<b>01-431.036</b>	4	9	0.009 kg	
			C	Universal 2.0 x 0.5 mm	<b>01-471.036</b>	4	10	0.009 kg	
	Snap-action switching element	1 NC + 1 NO	1	B	Universal-Solder	<b>01-743.0292</b>	4	11	0.010 kg
				C	Universal-Solder	<b>01-747.0292</b>	4	12	0.010 kg
2			B	Universal-Solder	<b>01-744.0292</b>	4	13	0.010 kg	
			C	Universal-Solder	<b>01-748.0292</b>	4	14	0.010 kg	
			B	Solder	<b>01-131.0252</b>		15	0.008 kg	
			B	Solder 2.8 x 0.5 mm	<b>01-131.022</b>		16	0.008 kg	
2 NC + 2 NO		1	B	Universal-Solder	<b>01-745.0292</b>	4	19	0.012 kg	
			C	Universal-Solder	<b>01-749.0292</b>	4	20	0.012 kg	
		2	B	Universal-Solder	<b>01-746.0292</b>	4	21	0.012 kg	
			C	Universal-Solder	<b>01-750.0292</b>	4	22	0.012 kg	
			B	Solder	<b>01-132.0252</b>		23	0.010 kg	
			C	Solder	<b>01-272.0252</b>		24	0.010 kg	
3 NC + 3 NO			B	Solder	<b>01-133.0252</b>		25	0.012 kg	
			C	Solder	<b>01-273.0252</b>		26	0.012 kg	
4 NC + 4 NO			B	Solder	<b>01-134.0252</b>		27	0.014 kg	
			C	Solder	<b>01-274.0252</b>		28	0.014 kg	

Contacts: NC = Normally closed, NO = Normally open  
 Switching action: B = Momentary, C = Maintain  
 The component layouts you will find from page 22

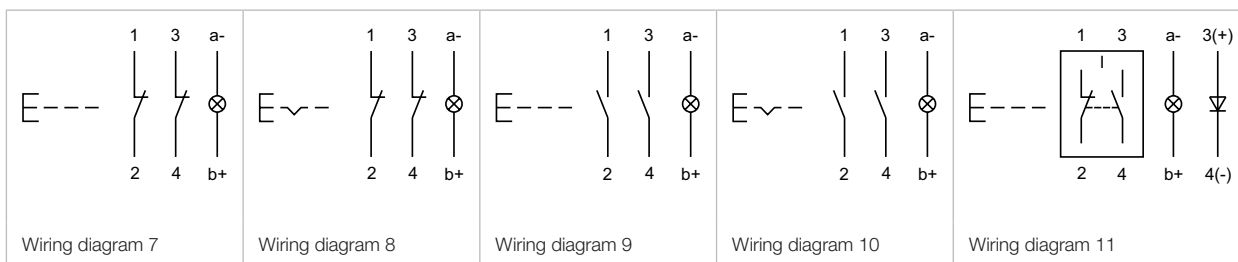
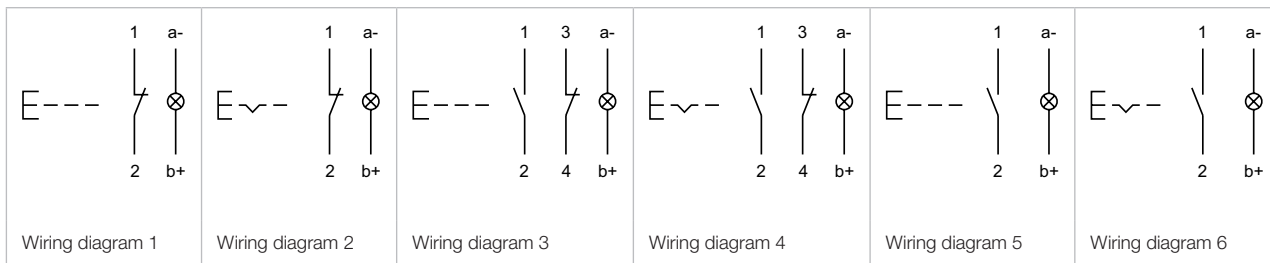



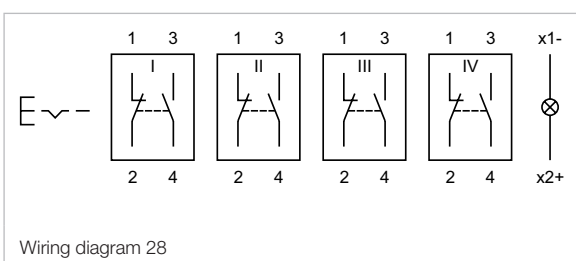
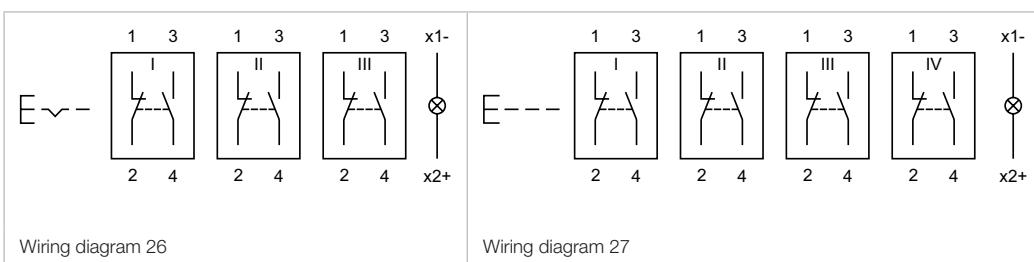
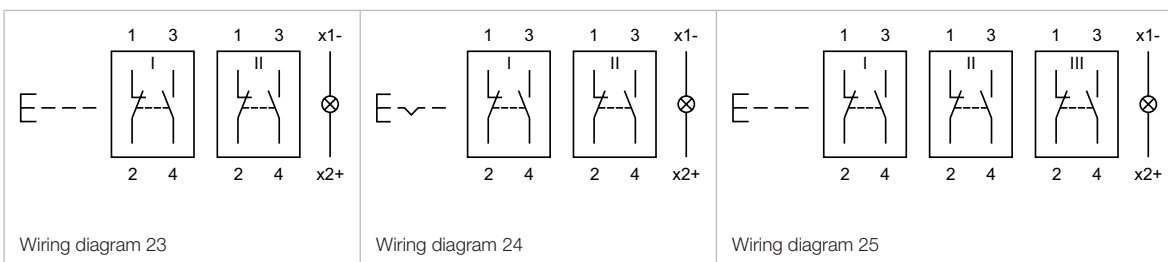
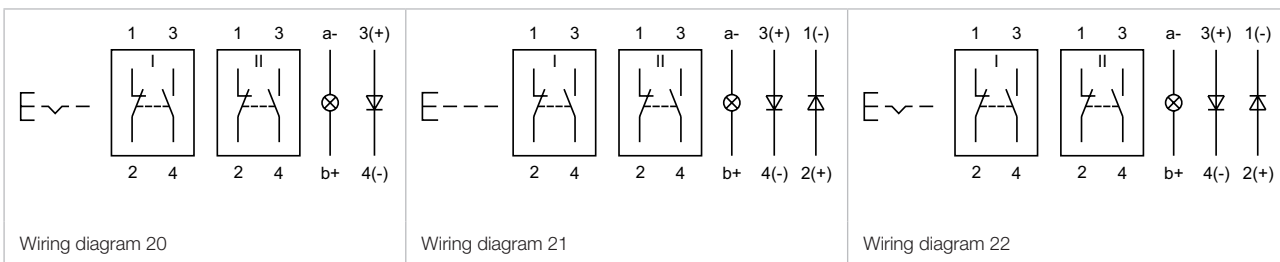
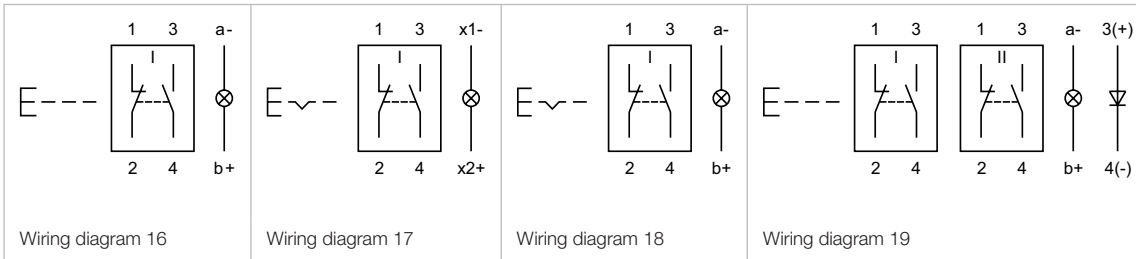
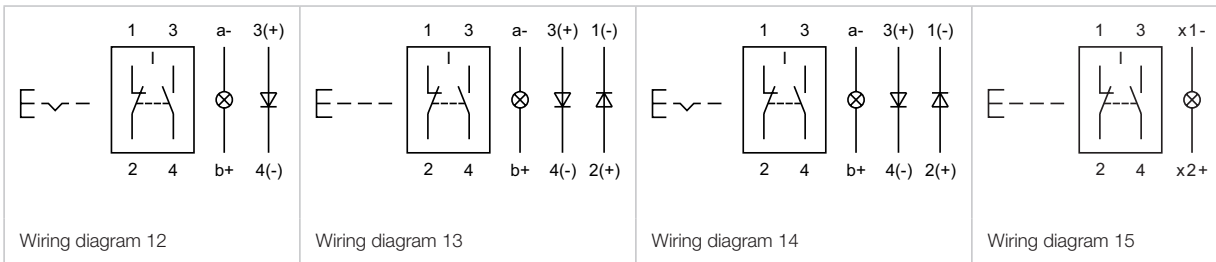



- 01
- 02
- 03
- 04
- 10
- 14
- 17
- 18
- 19
- 22
- 31
- 41
- 44
- 51
- 56
- 57
- 61
- 70
- 71
- 82
- 84
- 92
- 95
- 96
- 97
- 99
- ST

# 01 Accessories

## Front

### Lens plastic

Product attribute	Dimension	Lens	Part No.	Weight
 <b>Lens plastic</b>				
flat, illuminative	12.8 x 12.8 mm	red transparent	<b>01-985.2</b>	0.001 kg
		orange transparent	<b>01-985.3</b>	0.001 kg
		yellow transparent	<b>01-985.4</b>	0.001 kg
		green transparent	<b>01-985.5</b>	0.001 kg
		blue transparent	<b>01-985.6</b>	0.001 kg
		colourless transparent	<b>01-985.7</b>	0.001 kg
flat, illuminative, not suitable for film insert	12.8 x 12.8 mm	red translucent	<b>01-951.2</b>	0.001 kg
		orange translucent	<b>01-951.3</b>	0.001 kg
		yellow translucent	<b>01-951.4</b>	0.001 kg
		green translucent	<b>01-951.5</b>	0.001 kg
		blue translucent	<b>01-951.6</b>	0.001 kg
		white translucent	<b>01-951.9</b>	0.001 kg
flat, illuminative, less suitable for film insert	12.8 x 12.8 mm	red transparent	<b>01-975.2</b>	0.001 kg
		yellow transparent	<b>01-975.4</b>	0.001 kg
		green transparent	<b>01-975.5</b>	0.001 kg
		colourless transparent	<b>01-975.7</b>	0.001 kg
flat, non-illuminative	12.8 x 12.8 mm	black opaque	<b>01-951.0</b>	0.001 kg
		grey opaque	<b>01-951.8</b>	0.001 kg
 <b>Lens plastic</b>				
flat, illuminative	12.8 x 18.8 mm	red transparent	<b>01-982.2</b>	0.001 kg
		orange transparent	<b>01-982.3</b>	0.001 kg
		yellow transparent	<b>01-982.4</b>	0.001 kg
		green transparent	<b>01-982.5</b>	0.001 kg
		blue transparent	<b>01-982.6</b>	0.001 kg
		colourless transparent	<b>01-982.7</b>	0.001 kg
flat, illuminative, not suitable for film insert	12.8 x 18.8 mm	red translucent	<b>01-901.2</b>	0.001 kg
		orange translucent	<b>01-901.3</b>	0.001 kg
		yellow translucent	<b>01-901.4</b>	0.001 kg
		green translucent	<b>01-901.5</b>	0.001 kg
		blue translucent	<b>01-901.6</b>	0.001 kg
		white translucent	<b>01-901.9</b>	0.001 kg
flat, illuminative, less suitable for film insert	12.8 x 18.8 mm	red transparent	<b>01-972.2</b>	0.001 kg
		yellow transparent	<b>01-972.4</b>	0.001 kg
		green transparent	<b>01-972.5</b>	0.001 kg
		colourless transparent	<b>01-972.7</b>	0.001 kg
flat, non-illuminative	12.8 x 18.8 mm	black opaque	<b>01-901.0</b>	0.001 kg
		grey opaque	<b>01-901.8</b>	0.001 kg

Product attribute	Dimension	Lens	Part No.	Weight
 <b>Lens plastic</b>	Ø 15.8 mm	red transparent	<b>01-983.2</b>	0.001 kg
		orange transparent	<b>01-983.3</b>	0.001 kg
flat, illuminative	Ø 15.8 mm	yellow transparent	<b>01-983.4</b>	0.001 kg
		green transparent	<b>01-983.5</b>	0.001 kg
		blue transparent	<b>01-983.6</b>	0.001 kg
		colourless transparent	<b>01-983.7</b>	0.001 kg
		red translucent	<b>01-931.2</b>	0.001 kg
		orange translucent	<b>01-931.3</b>	0.001 kg
flat, illuminative, not suitable for film insert	Ø 15.8 mm	yellow translucent	<b>01-931.4</b>	0.001 kg
		green translucent	<b>01-931.5</b>	0.001 kg
		blue translucent	<b>01-931.6</b>	0.001 kg
		white translucent	<b>01-931.9</b>	0.001 kg
		red transparent	<b>01-973.2</b>	0.001 kg
flat, illuminative, less suitable for film insert	Ø 15.8 mm	yellow transparent	<b>01-973.4</b>	0.001 kg
		green transparent	<b>01-973.5</b>	0.001 kg
		colourless transparent	<b>01-973.7</b>	0.001 kg
		black opaque	<b>01-931.0</b>	0.001 kg
flat, non-illuminative	Ø 15.8 mm	grey opaque	<b>01-931.8</b>	0.001 kg

01  
02  
03  
04  
10  
14  
17  
18  
19  
22  
31  
41  
44  
51  
56  
57  
61  
70  
71  
82  
84  
92  
95  
96  
97  
99  
ST

# 01 Accessories



## Protective cover, IP 40

### Additional Information

- Hinged, with means for sealing
- Front panel thickness reduces by 2 mm
- Please note that bigger minimum distances are necessary

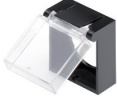

Dimensions [mm]

Product attribute	Material	Optics	Dimension	Part No.	Weight
 <b>Protective cover</b>					
for button 18 x 18 mm with mounting cut-out Ø16 mm	Plastic	transparent		<b>31-920</b>	0.002 kg
 <b>Protective cover</b>					
for button 18 x 24 mm with mounting cut-out Ø16 mm	Plastic	transparent	18 x 24 mm	<b>01-925</b>	0.002 kg

## Front protective cap, IP 67

### Additional Information

- Two-part
- Please note that bigger minimum distances are necessary

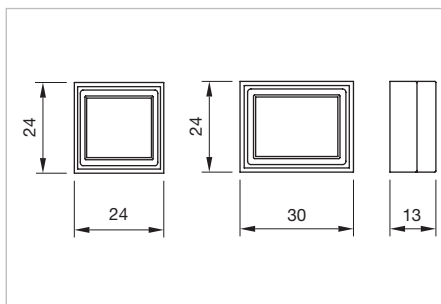

Dimensions [mm]

Product attribute	Dimension	Material	Colour	Optics	Part No.	Weight
 <b>Front protective cap</b>						
for button 18 x 18 mm with mounting cut-out Ø16 mm	24 x 24 mm	PVC/PE	colourless	transparent	<b>31-923</b>	0.003 kg
for button 18 x 24 mm with mounting cut-out Ø16 mm	24 x 30 mm	PE/Silicone	colourless	transparent	<b>31-924.2</b>	0.003 kg

**Protective guard**

**Additional Information**

- Please note that bigger minimum distances are necessary



Dimensions [mm]

Product attribute	Dimension	Material	Colour	Part No.	Weight
 <p><b>Protective guard</b></p> <p>narrow ends bent upwards, for button 18 x 24 mm with mounting cut-out Ø16 mm</p>	18 x 26 mm	Brass	matt chrome	<b>01-926</b>	0.011 kg
 <p><b>Protective guard</b></p> <p>broad sides bent upwards, for button 18 x 24 mm with mounting cut-out Ø16 mm</p>	20 x 24 mm	Brass	matt chrome	<b>01-927</b>	0.011 kg

01

02

03

04

10

14

17

18

19

22

31

41

44

51

56

57

61

70

71

82

84

92

95

96

97

99

ST



# 01 Accessories

01  
02  
03  
04  
10  
14  
17  
18  
19  
22  
31  
41  
44  
51  
56  
57  
61  
70  
71  
82  
84  
92  
95  
96  
97  
99  
ST

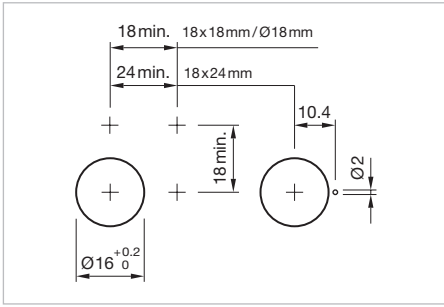
## Blind plug



Mounting cut-outs [mm]

Dimension	Material	Colour	Part No.	Weight
 <b>Blind plug</b>				
18 x 18 mm	Plastic	black	<b>01-948.0</b>	0.001 kg
 <b>Blind plug</b>				
18 x 24 mm	Plastic	black	<b>01-947.0</b>	0.001 kg
 <b>Blind plug</b>				
Ø 18 mm	Plastic	black	<b>01-949.0</b>	0.001 kg

Rear side

PCB plug-in base

Additional Information

- PCB plug-in base pins right-angle: With the extendable mounting the distance between plug-in base and PCB can be varied up to 3 mm

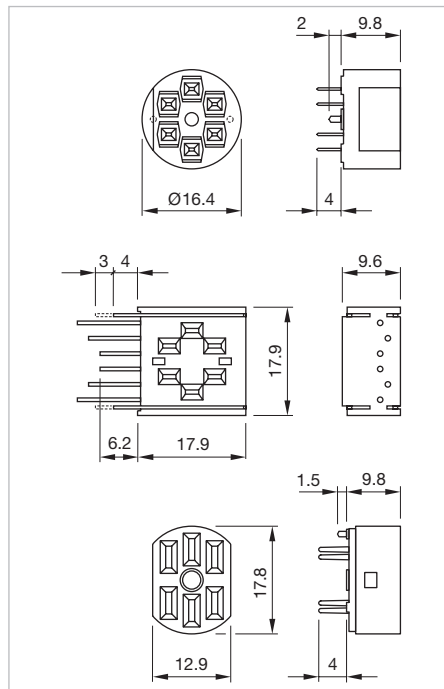

Dimensions [mm]

Product attribute	Pins	Terminal	Part No.	Component layout	Weight
 <p><b>PCB plug-in base</b></p>					
for low level switching element	axial	PCB	<b>31-940</b>	3	0.002 kg
 <p><b>PCB plug-in base</b></p>					
for low level switching element	right-angled	PCB	<b>31-941</b>	1	0.004 kg
 <p><b>PCB plug-in base</b></p>					
for snap-action switching element 2.8 mm	axial	PCB	<b>31-942</b>	2	0.002 kg

The component layouts you will find from page 22

01  
02  
03  
04  
10  
14  
17  
18  
19  
22  
31  
41  
44  
51  
56  
57  
61  
70  
71  
82  
84  
92  
95  
96  
97  
99  
ST



# 01 Accessories

01  
02  
03  
04  
10  
14  
17  
18  
19  
22  
31  
41  
44  
51  
56  
57  
61  
70  
71  
82  
84  
92  
95  
96  
97  
99  
ST

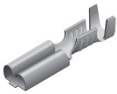
## Flat receptacle

Product attribute	Part No.	Weight
 <p><b>Flat receptacle</b></p>		
2.0 x 0.5 mm plug-in terminal	<b>31-945</b>	0.001 kg
 <p><b>Flat receptacle</b></p>		
2.8 x 0.5 mm plug-in terminal	<b>31-946</b>	0.001 kg

## Insulation sleeve

Product attribute	Part No.	Weight
 <p><b>Insulation sleeve</b></p>		
for flat receptacle 2.0 mm	<b>31-928</b>	0.001 kg
 <p><b>Insulation sleeve</b></p>		
for flat receptacle 2.8 mm	<b>31-929</b>	0.001 kg
 <p><b>Insulation sleeve</b></p>		
cover plug-in terminals for snap-action switching element 2.8 mm	<b>01-928</b>	0.001 kg

## Terminal cover

Part No.	Weight
 <p><b>Terminal cover for snap-action switching element 16</b></p>	
<b>01-929</b>	0.010 kg



**Illumination**

**Single-LED, T6.8**

**Additional Information**

- For LED element fitting information see «Application guidelines»
- Due to high surface temperatures, the series resistor must not be soldered directly to the terminals of the equipment (use a terminal plate)
- When using AC/DC types with AC operation, slight flickering can occur
- Luminous intensity data of the LEDs on direct voltage
- Electrical and optical data are measured at 25 °C
- The specified versions are built with a protection diode (half wave rectifier) in series and the LED
- Luminosity and wave length variations caused by LED manufacturing processes may cause slight differences regarding the illumination
- For supply voltages above 48 V, a voltage reduction element (external series resistor or transformer) must be used

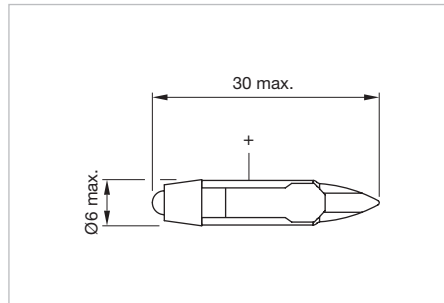

Dimensions [mm]

LED colour	Operating voltage	Operation current	Lumi. intensity	Dom. wavelength	Part No.	Weight
 <p><b>Single-LED</b></p>						
Single-LED red	6 VDC +10 %	15 mA ±15 %	350 mcd	630 nm	<b>10-2106.3142</b>	0.001 kg
	12 VAC/DC +10 %	7/14 mA ±15 %	330 mcd	630 nm	<b>10-2109.1062</b>	0.001 kg
	24 VAC/DC +10 %	7/14 mA ±15 %	330 mcd	630 nm	<b>10-2112.1062</b>	0.001 kg
	28 VAC/DC +10 %	7/14 mA ±15 %	330 mcd	630 nm	<b>10-2113.1062</b>	0.001 kg
	48 VAC/DC +10 %	4/8 mA ±15 %	200 mcd	630 nm	<b>10-2119.1042</b>	0.001 kg
Single-LED yellow	6 VDC +10 %	15 mA ±15 %	300 mcd	587 nm	<b>10-2106.3144</b>	0.001 kg
	12 VAC/DC +10 %	7/14 mA ±15 %	280 mcd	587 nm	<b>10-2109.1064</b>	0.001 kg
	24 VAC/DC +10 %	7/14 mA ±15 %	280 mcd	587 nm	<b>10-2112.1064</b>	0.001 kg
	28 VAC/DC +10 %	7/14 mA ±15 %	280 mcd	587 nm	<b>10-2113.1064</b>	0.001 kg
	48 VAC/DC +10 %	4/8 mA ±15 %	180 mcd	587 nm	<b>10-2119.1044</b>	0.001 kg
Single-LED green	6 VDC +10 %	7 mA ±15 %	1050 mcd	525 nm	<b>10-2106.3145</b>	0.001 kg
	12 VAC/DC +10 %	4/7 mA ±15 %	1050 mcd	525 nm	<b>10-2109.1065</b>	0.001 kg
	24 VAC/DC +10 %	4/7 mA ±15 %	1050 mcd	525 nm	<b>10-2112.1065</b>	0.001 kg
	28 VAC/DC +10 %	4/7 mA ±15 %	1050 mcd	525 nm	<b>10-2113.1065</b>	0.001 kg
	48 VAC/DC +10 %	2/4 mA ±15 %	600 mcd	525 nm	<b>10-2119.1045</b>	0.001 kg
Single-LED blue	6 VDC +10 %	15 mA ±15 %	680 mcd	470 nm	<b>10-2106.3146</b>	0.001 kg
	12 VAC/DC +10 %	7/14 mA ±15 %	650 mcd	470 nm	<b>10-2109.1066</b>	0.001 kg
	24 VAC/DC +10 %	7/14 mA ±15 %	650 mcd	470 nm	<b>10-2112.1066</b>	0.001 kg
	28 VAC/DC +10 %	7/14 mA ±15 %	650 mcd	470 nm	<b>10-2113.1066</b>	0.001 kg
	48 VAC/DC +10 %	4/8 mA ±15 %	400 mcd	470 nm	<b>10-2119.1046</b>	0.001 kg

01  
02  
03  
04  
10  
14  
17  
18  
19  
22  
31  
41  
44  
51  
56  
57  
61  
70  
71  
82  
84  
92  
95  
96  
97  
99  
ST

# 01 Accessories

LED colour	Operating voltage	Operation current	Lumi. intensity	Dom. wavelength	Part No.	Weight
Single-LED white	6 VDC +10 %	15 mA ±15 %	750 mcd	x0.31/y0.32 nm	<b>10-2106.3149</b>	0.001 kg
	12 VAC/DC +10 %	7/14 mA ±15 %	700 mcd	x0.31/y0.32 nm	<b>10-2109.1069</b>	0.001 kg
	24 VAC/DC +10 %	7/14 mA ±15 %	700 mcd	x0.31/y0.32 nm	<b>10-2112.1069</b>	0.001 kg
	28 VAC/DC +10 %	7/14 mA ±15 %	700 mcd	x0.31/y0.32 nm	<b>10-2113.1069</b>	0.001 kg
	48 VAC/DC +10 %	4/8 mA ±15 %	400 mcd	x0.31/y0.32 nm	<b>10-2119.1049</b>	0.001 kg

## Filament lamp, T6.8

Operating voltage	Operation current	Part No.	Weight
 <p><b>Filament lamp</b></p>			
6 VAC/DC	200 mA	<b>10-1106.1369</b>	0.001 kg
12 VAC/DC	50 mA	<b>10-1109.1279</b>	0.001 kg
12 VAC/DC	100 mA	<b>10-1109.1329</b>	0.001 kg
24 VAC/DC	25 mA	<b>10-1112.1199</b>	0.001 kg
24 VAC/DC	50 mA	<b>10-1112.1279</b>	0.001 kg
28 VAC/DC	40 mA	<b>10-1113.1249</b>	0.001 kg
30 VAC/DC	40 mA	<b>10-1114.1249</b>	0.001 kg
36 VAC/DC	35 mA	<b>10-1116.1229</b>	0.001 kg
48 VAC/DC	25 mA	<b>10-1119.1199</b>	0.001 kg

## Series resistor

### Additional Information

- For lamp voltage reduction
- Only for filament lamp 48 VAC, 25 mA
- Keep to the country specific safety instructions
- Due to high surface temperatures, the series resistor must not be soldered directly to the terminals of the equipment (use a terminal plate)

Operating voltage	Resistance	Part No.	Weight
 <p><b>Series resistor</b></p>			
110 VAC	2.7 kOhm	<b>02-904.0</b>	0.003 kg
125 VAC	3.3 kOhm	<b>02-904.1</b>	0.003 kg
145 VAC	4.7 kOhm	<b>02-904.3</b>	0.003 kg
240 VAC	10 kOhm	<b>02-904.7</b>	0.003 kg

**Terminal plate empty**

**Additional Information**

- For fitting with series resistors

Product attribute	Dimension	Part No.	Weight
 <p><b>Terminal plate empty</b></p>			
5 spaces	62.5 x 60 x 15 mm	<b>02-912.1</b>	0.025 kg
10 spaces	125 x 60 x 15 mm	<b>02-912.2</b>	0.045 kg
15 spaces	187.6 x 60 x 15 mm	<b>02-912.3</b>	0.090 kg
20 spaces	250 x 60 x 15 mm	<b>02-912.4</b>	0.095 kg

01  
02  
03  
04  
10  
14  
17  
18  
19  
22  
31  
41  
44  
51  
56  
57  
61  
70  
71  
82  
84  
92  
95  
96  
97  
99  
ST

# 01 Accessories

01

## Mounting

02

### Lens remover

03

04

10

14

17

Part No.	Weight
 <b>Lens remover</b>	
02-905	0.011 kg

18

### Lamp remover

19

22

31

41

44

51

56

**Additional Information**

▲ **Caution:** A switching process might be released when replacing the lamp

Part No.	Weight
 <b>Lamp remover</b>	
02-906	0.002 kg

57

### Mounting tool

61

70

71

82

84

92

95

96

97

99

ST

**Additional Information**

- For tightening or loosening of the fixing nut

Part No.	Weight
 <b>Mounting tool</b>	
01-907	0.020 kg

**Dressing tool**

**Additional Information**

- For aligning buttons

Part No.	Weight
 <p data-bbox="272 595 427 629"><b>Dressing tool</b></p>	
01-906	0.030 kg

01

02

03

04

10

14

17

18

19

22

31

41

44

51

56

57

61

70

71

82

84

92

95

96

97

99

ST

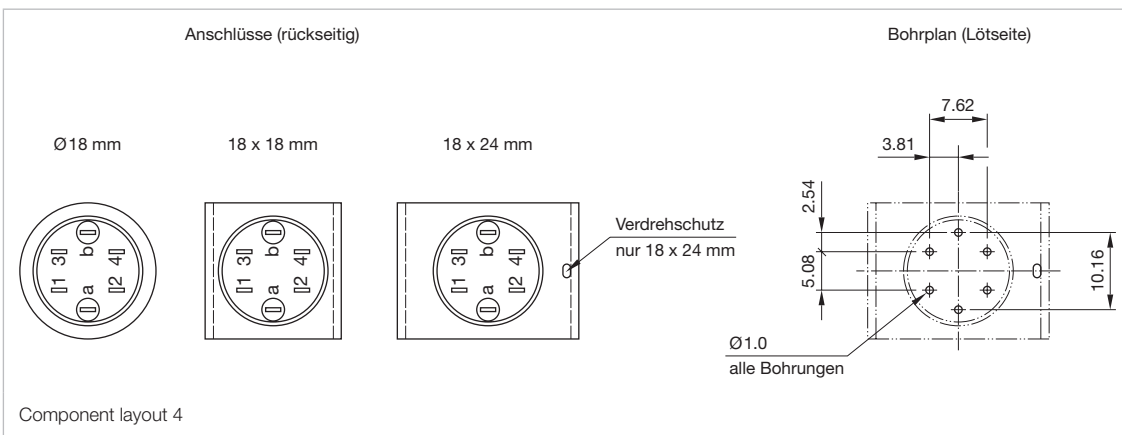
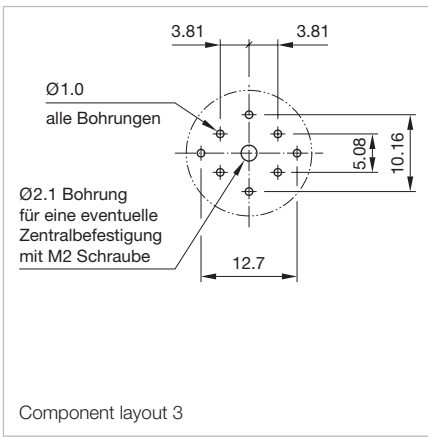
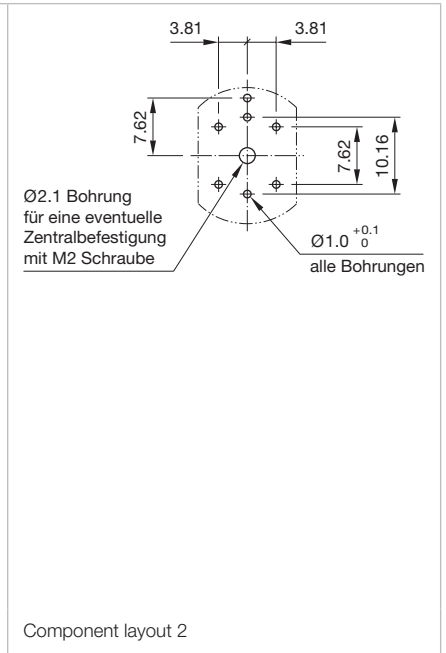
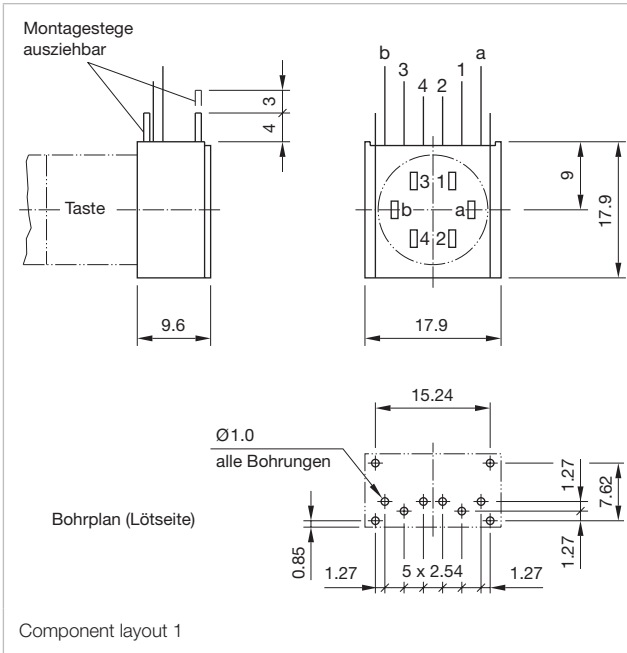

**Actuator with snap-action switching element**
**Switching system**

Self-cleaning, double-break, snap action switching system (with contact gap 2 x 0.5 mm).

1 Normally closed or 1 Normally open contact per element.

Snap-action switching elements with soldering terminals at the sides: Up to 4 switching element can be on a pushbutton (max. 4 Normally closed and 4 Normally open contacts).

Snap-action switching element with axial plug-in terminals 2.8 mm stachable, only 1 switching element can be on a pushbutton.

**Material**
**Material of contact**

Gold plated silver

**Switch housing**

Axial plug-in-/soldering terminal 2.8 mm:

Diallylphthalate (DAP), Polyamide (PA66), Polysulfone (PSU), heat-resistant and self-extinguishing

Soldering terminal: Ultramide (PA 6.6)

**Actuator housing**

Polyphenylene (PPO), self-extinguishing

**Mechanical characteristics**
**Terminals**

Snap-action switching element with tinned soldering terminals at the sides:

Max. wire diameter 2 wires à 1.2 mm

Max. wire cross-section of stranded cable 1 x 1 mm<sup>2</sup>

Snap-action switching element with axial plug-in terminals, which can also be used as soldering terminals: Plug-in terminal 2.8 x 0.5 mm

Soldering terminal:

Max. wire diameter 2 wire of 1 mm<sup>2</sup>

Max. wire cross-section of stranded cable 2 x 0.75 mm<sup>2</sup> or 1 x 1 mm<sup>2</sup>

**Tightening torque**

for fixing nut max. 25 Ncm

**Actuating force**

2 N ... 5.5 N, depending on the number of switching elements

**Actuating travel**

3 mm

**Rebound time**

≤5ms

**Mechanical lifetime**

Momentary action 2 million cycles of operation

Maintained action 1 million cycles of operation

**Electrical characteristics**
**Standards**

IEC 61058, EN 61058

**Rated voltage**

250 VAC/VDC

**Rated current**

5 A

**Contact resistance**

Starting value (initial) ≤50 mΩ

**Conventional free air thermal current**

5 A

The maximum current in continuous operation and at ambient temperature not exceeding the quoted maximum values.

**Switch rating**

250 VAC, 5 A (cosφ 1)

250 VAC, 3 A (cosφ 0,3)

Switch rating AC (cosφ 0,7)

Voltage	125 VAC	250 VAC
---------	---------	---------

Current	3 A	2 A
---------	-----	-----

Switch rating DC (inductive) L:R = 30 ms

Voltage	24 VDC	60 VDC	110 VDC	220 VDC
---------	--------	--------	---------	---------

Current	2 A	0.7 A	0.2 A	0.1 A
---------	-----	-------	-------	-------

**Electric strength**

2500 VAC, 50 Hz, 1 min. between all terminals and earth, as per IEC 60512-2-11

**Protection class**

II

**Environmental conditions**
**Storage temperature**

-40 °C ... +85 °C

**Service temperature**

-25 °C ... +55 °C

For indicators and illuminated pushbuttons mounted as a block, make sure the heat can escape freely.

**Protection degree**

Front P 40

IP 67 with front protective cap

**Shock resistance**

(Single impacts, semi-sinusoidal)

15 g for 11 ms, as per IEC 60512-4-3, IEC 60068-2-27

**Vibration resistance**

(sinusoidal)

10 g at 0-2000 Hz, amplitude 1.5 mm, as per IEC 60512-4-4, IEC 60068-2-6

# 01 Technical data

01

## Approvals

### Approbations

CB (IEC 61058)  
CSA  
ENEC (EN 61058)  
Germanischer Lloyd  
UL

### Declaration of conformity

CE

## Actuator with low level switching element

### Switching system

This low level switching element was designed for switching low powers in electronic circuits. The mechanism assures reliable switching of loads ranging from a few  $\mu\text{A}$  /  $\mu\text{V}$  up to 100 mA / 42 VAC/DC.

Single-break momentary contact, as normally open or normally closed with 4 independent points of contact. 2 momentary contacts per switching element; combination of normally open and normally closed is possible.

Special features are the long life, extremely short rebound time and stable contact resistance.

### Material

#### Material of contact

Gold plated

#### Switch housing

Polysulfone (PSU), heat-resistant and self-extinguishing

#### Actuator housing

Polyphenylene (PPO), self-extinguishing

### Mechanical characteristics

#### Terminals

The universal terminals permit these units to be mounted on printed circuit boards (PCB). These terminals can also be used as soldering or plug-in terminals.

For these terminals we can also supply a plug-in base which, when soldered on to the board, enables the switch to be plugged in.

Soldering terminal:

Max. wire diameter 2 wires à 0.8 mm

Max. wire cross-section of stranded cable 1x 0.75 mm<sup>2</sup>

Plug-in terminal: 2.0 x 0.5 mm

#### Actuating force

3 N ... 3,5 N

#### Actuating travel

3 mm

#### Rebound time

Typ. <100  $\mu\text{s}$

### Mechanical lifetime

Momentary action 5 million cycles of operation

Maintained action 1 million cycles of operation

### Electrical characteristics

#### Standards

EN 61058

#### Contact resistance

Starting value (initial)  $\leq 50 \text{ m}\Omega$

Switch rating

10  $\mu\text{A}$ , 100  $\mu\text{V}$  to 100 mA at 42 VAC/VDC

#### Electric strength

2500 VAC, 50 Hz, 1 min. between all terminals and earth, as per IEC 60512-2-11

#### Protection class

II

### Environmental conditions

#### Storage temperature

-40 °C ... +85 °C

#### Service temperature

-25 °C ... +55 °C

For indicators and illuminated pushbuttons mounted as a block, make sure the heat can escape freely.

#### Protection degree

Front P 40

IP 67 with front protective cap

#### Shock resistance

(Single impacts, semi-sinusoidal)

15 g for 11 ms, as per IEC 60512-4-3, IEC 60068-2-27

#### Climate resistance

Standard condition, as per IEC 60068-2-3 and 2-30

Changing condition, as per IEC 60068-2-14 and 2-33

*EAO reserves the right to alter specifications without further notice.*



## General notes

### 1. Engraving

In addition to the most commonly used world languages, in DIN1451-3 close spacing, other typefaces are available as Scandinavian, Slavic, Greek, Russian and Polish. Red, blue and black lenses are filled with white colour. Other colour lenses are filled in black. Standard height of letters is 2mm. If the height is not specified, we will supply 2mm engraved letters.

### 2. Hot stamping

For larger series it is worth considering markings by means of hot stamping. We will pleased to advise you. For letters and figures, typefaces with 2.5mm, 3mm and 4mm are available.

### 3. Film inserts

Instead of using engraving the lenses can be fitted with transparent film inserts, as an alternative. For this purpose, though, it is advisable to use transparent lenses. In the case of use of a smoke-black lens the fitted film becomes readable only if the lamp is on. To insert the film, the feet of the lens holder have to be pushed together far enough to enable the lens to be lift off easily. The film thickness is 0.2mm.

**Important: Consider pushbutton mounting orientation before specifying engraving characters!**

All dimensions in mm

Front size (Lens)	Film insert max. size	Height of letters h	Number of lines	Number of capital letters per line (target value)	Number of small letters per line (target value)	Image		
18 x 18 (12.8 x 12.8)	10.2 x 10.2	2.5	3	6-7	7	B3		
		3.0	2	5-6	6	B3		
		4.0	2	4	4	B3		
		5.0	1	3	3-4	B3		
		6.0	1	2-3	3	B3		
		8.0	1	2	2	B3		
18 x 24 (12.8 x 18.8)	10.2 x 16.2	2.5	3	10	10-11	B1		
		2.5	4	6-7	7	B2		
		3.0	2	8-9	9	B3		
		3.0	4	5-6	6	B4		
		4.0	2	6	6-7	B2		
		4.0	3	4	4	B1		
		5.0	1	5	5-6	B2		
		5.0	2	3	3-4	B1		
		6.0	1	4	4-5	B2		
		6.0	1	2-3	3	B1		
		8.0	1	3	3-4	B2		
		8.0	1	2	2	B2		
		Ø 18 (Ø 15.8)	Ø 12.8	2.5	3	6	6	B4
				3.0	2	5	6	B4
4.0	2			3	4	B4		
5.0	1			2	3	B4		
6.0	1			2	2	B4		
8.0	1			2	2	B4		



# 01 Application guidelines

## 01 Suppressor circuits

When switching inductive loads such as relays, DC motors, and DC solenoids, it is always important to absorb surges (e.g. with a diode) to protect the contacts. When these inductive loads are switched off, a counter emf can severely damage switch contacts and greatly shorten lifetime.

Fig. 1 shows an inductive load with a free-wheeling diode connected in parallel. This free-wheeling diode provides a path for the inductor current to flow when the current is interrupted by the switch. Without this free-wheeling diode, the voltage across the coil will be limited only by dielectric breakdown voltages of the circuit or parasitic elements of the coil. This voltage can be kilovolts in amplitude even when nominal circuit voltages are low (e.g. 12VDC) see Fig. 2.

The free-wheeling diode should be chosen so that the reverse breakdown voltage is greater than the voltage driving the inductive load. The DC blocking voltage ( $V_R$ ) of the free-wheeling diode can be found in the datasheet of a diode. The forward current should be equal or greater than the maximum current flowing through the load.

**To get an efficient protection, the free-wheeling diode must be connected as close as possible to the inductive load!**

Switching with inductive load  
Fig. 1



Counter EMF  
over load without free-wheeling diode  
Fig. 2

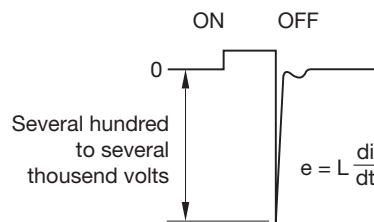

## LED polarity

When fitting the LED elements the polarity has to correspond with the respective terminals, (+) goes to +.

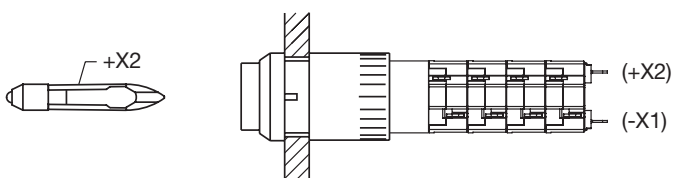

## Diode element for lamp check

When indicators and illuminated pushbuttons equipped with diodes, the user is able to perform a lamp check or wire an alarm circuit simply with a considerable saving of space.

Lamp check



Lamp check with blocking diodes



Alarm circuit from fault annunciation system



Lamp check and alarm circuit



Lamp check and alarm circuit with only one diode and AC voltage



LK = Lamp control

01

02

03

04

10

14

17

18

19

22

31

41

44

51

56

57

61

70

71

82

84

92

95

96

97

99

ST

# 01 Index

01

## Index from Part No.

Part No.	Page	Part No.	Page	Part No.	Page
01-030.002	5	01-709.0292	6	01-983.5	11
01-030.005	5	01-710.0292	6	01-983.6	11
01-031.006	5	01-711.0292	6	01-983.7	11
01-040.002	4	01-712.0292	7	01-985.2	10
01-040.005	4	01-713.0292	7	01-985.3	10
01-041.006	4	01-714.0292	7	01-985.4	10
01-050.002	4	01-715.0292	7	01-985.5	10
01-050.005	4	01-716.0292	7	01-985.6	10
01-051.006	4	01-717.0292	6	01-985.7	10
01-121.022	7	01-718.0292	6	02-904.0	18
01-121.0252	7	01-719.0292	6	02-904.1	18
01-122.0252	7	01-720.0292	7	02-904.3	18
01-123.0252	7	01-741.006	5	02-904.7	18
01-124.0252	7	01-742.006	5	02-905	20
01-131.022	8	01-743.0292	8	02-906	20
01-131.0252	8	01-744.0292	8	02-912.1	19
01-132.0252	8	01-745.0292	8	02-912.2	19
01-133.0252	8	01-746.0292	8	02-912.3	19
01-134.0252	8	01-747.0292	8	02-912.4	19
01-151.022	6	01-748.0292	8	10-1106.1369	18
01-151.0252	6	01-749.0292	8	10-1109.1279	18
01-152.0252	7	01-750.0292	8	10-1109.1329	18
01-153.0252	7	01-901.0	10	10-1112.1199	18
01-154.0252	7	01-901.2	10	10-1112.1279	18
01-261.022	7	01-901.3	10	10-1113.1249	18
01-261.0252	7	01-901.4	10	10-1114.1249	18
01-262.0252	7	01-901.5	10	10-1116.1229	18
01-263.0252	7	01-901.6	10	10-1119.1199	18
01-264.0252	7	01-901.8	10	10-2106.3142	17
01-271.022	8	01-901.9	10	10-2106.3144	17
01-271.0252	8	01-906	21	10-2106.3145	17
01-272.0252	8	01-907	20	10-2106.3146	17
01-273.0252	8	01-925	12	10-2106.3149	18
01-274.0252	8	01-926	13	10-2109.1062	17
01-281.022	6	01-927	13	10-2109.1064	17
01-281.0252	6	01-928	16	10-2109.1065	17
01-282.0252	7	01-929	16	10-2109.1066	17
01-283.0252	7	01-931.0	11	10-2109.1069	18
01-284.0252	7	01-931.2	11	10-2112.1062	17
01-421.036	7	01-931.3	11	10-2112.1064	17
01-422.036	7	01-931.4	11	10-2112.1065	17
01-423.036	7	01-931.5	11	10-2112.1066	17
01-425.036	7	01-931.6	11	10-2112.1069	18
01-426.036	7	01-931.8	11	10-2113.1062	17
01-431.036	8	01-931.9	11	10-2113.1064	17
01-432.036	8	01-947.0	14	10-2113.1065	17
01-433.036	8	01-948.0	14	10-2113.1066	17
01-435.036	8	01-949.0	14	10-2113.1069	18
01-436.036	8	01-951.0	10	10-2119.1042	17
01-451.036	6	01-951.2	10	10-2119.1044	17
01-452.036	6	01-951.3	10	10-2119.1045	17
01-453.036	6	01-951.4	10	10-2119.1046	17
01-455.036	6	01-951.5	10	10-2119.1049	18
01-456.036	6	01-951.6	10	31-920	12
01-461.036	7	01-951.8	10	31-923	12
01-462.036	7	01-951.9	10	31-924.2	12
01-463.036	7	01-972.2	10	31-928	16
01-465.036	7	01-972.4	10	31-929	16
01-466.036	7	01-972.5	10	31-940	15
01-471.036	8	01-972.7	10	31-941	15
01-472.036	8	01-973.2	11	31-942	15
01-473.036	8	01-973.4	11	31-945	16
01-475.036	8	01-973.5	11	31-946	16
01-476.036	8	01-973.7	11		
01-481.036	6	01-975.2	10		
01-482.036	6	01-975.4	10		
01-483.036	6	01-975.5	10		
01-485.036	6	01-975.7	10		
01-486.036	6	01-982.2	10		
01-701.006	4	01-982.3	10		
01-702.006	4	01-982.4	10		
01-703.006	4	01-982.5	10		
01-704.006	4	01-982.6	10		
01-705.0292	7	01-982.7	10		
01-706.0292	7	01-983.2	11		
01-707.0292	7	01-983.3	11		
01-708.0292	7	01-983.4	11		

Компания «Life Electronics» занимается поставками электронных компонентов импортного и отечественного производства от производителей и со складов крупных дистрибьюторов Европы, Америки и Азии.

С конца 2013 года компания активно расширяет линейку поставок компонентов по направлению коаксиальный кабель, кварцевые генераторы и конденсаторы (керамические, пленочные, электролитические), за счёт заключения дистрибьюторских договоров

Мы предлагаем:

- Конкурентоспособные цены и скидки постоянным клиентам.
- Специальные условия для постоянных клиентов.
- Подбор аналогов.
- Поставку компонентов в любых объемах, удовлетворяющих вашим потребностям.
- Приемлемые сроки поставки, возможна ускоренная поставка.
- Доставку товара в любую точку России и стран СНГ.
- Комплексную поставку.
- Работу по проектам и поставку образцов.
- Формирование склада под заказчика.
- Сертификаты соответствия на поставляемую продукцию (по желанию клиента).
- Тестирование поставляемой продукции.
- Поставку компонентов, требующих военную и космическую приемку.
- Входной контроль качества.
- Наличие сертификата ISO.

В составе нашей компании организован Конструкторский отдел, призванный помогать разработчикам, и инженерам.

Конструкторский отдел помогает осуществить:

- Регистрацию проекта у производителя компонентов.
- Техническую поддержку проекта.
- Защиту от снятия компонента с производства.
- Оценку стоимости проекта по компонентам.
- Изготовление тестовой платы монтаж и пусконаладочные работы.



Тел: +7 (812) 336 43 04 (многоканальный)  
Email: [org@lifeelectronics.ru](mailto:org@lifeelectronics.ru)