

# R2A20134SP

R03DS0033EJ0301

Rev.3.01

Jan 08, 2016

## LED Lighting Power Controller

### Description

R2A20134SP is a LED lighting controller IC.

Control method is selectable for each system demand, fixed frequency or zero current detection mode.

High accuracy LED current feed-back system makes more efficient LED performance.

Critical Conduction Mode PFC control realizes high power factor and zero current switching.

And Peak Current Mode makes it possible to reduce external parts and realize low system cost.

### Features

- Absolute Maximum Ratings
  - Supply voltage  $V_{cc}$ : 24 V
  - Junction temperature  $T_j$ :  $-40$  to  $+150^{\circ}\text{C}$
- Electrical characteristics
  - UVLO operation start voltage  $V_H$ :  $12\text{ V} \pm 0.8\text{ V}$
  - UVLO operation shutdown voltage  $V_L$ :  $9.2\text{ V} \pm 0.7\text{ V}$
  - UVLO hysteresis voltage  $H_{ysuvl}$ :  $2.8\text{ V} \pm 0.7\text{ V}$
- Functions
  - Selectable for each targeted system,
    1. Zero current detection mode (When  $R_{rt}$  is connected by GND)
    2. Fixed frequency mode (When  $R_{rt}$  is connected by  $V_{ref}$ )
  - Adjustable for Switching frequency (When  $R_{rt}$  is connected by  $V_{ref}$ )
  - Overcurrent protection
  - Package lineup: Pb-free SOP-8 (JEDEC)

### Ordering Information

Part No.	Package Name	Package Code	Package Abbreviation	Taping Abbreviation (Quantity)
R2A20134SP#W5	—	PRSP0008DJ-A	SP	W (2,500 pcs/reel)

## Pin Arrangement

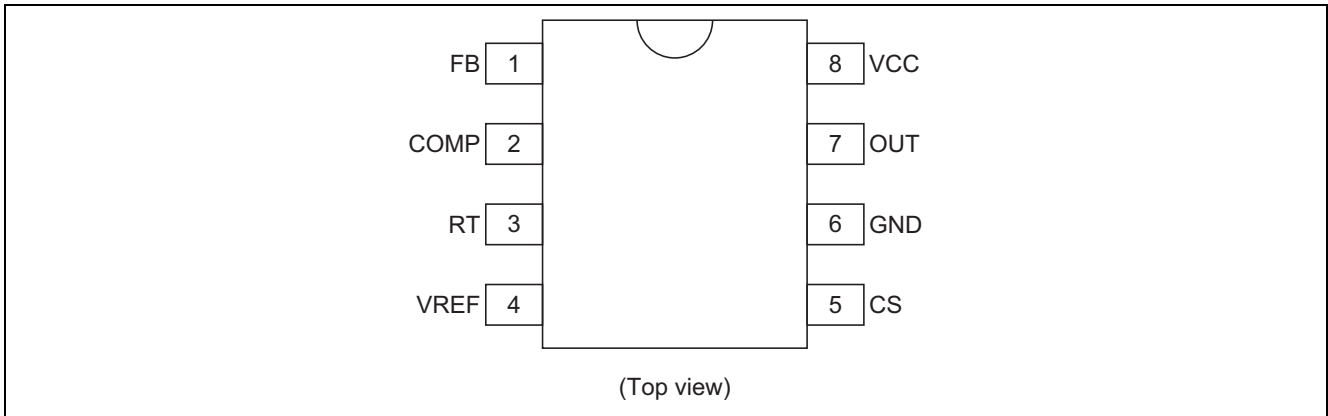

## Pin Function

Pin No.	Pin Name	Input/Output	Function
1	FB	Input	Error amplifier input terminal
2	COMP	Output	Error amplifier output terminal
3	RT	Input/Output	A resistor connection terminal for RAMP current setting
4	VREF	Output	Reference voltage output terminal
5	CS	Input	Zero current detection and overcurrent detection input terminal
6	GND	—	Ground
7	OUT	Output	Power MOSFET drive terminal
8	VCC	Input	Supply voltage terminal

### Block Diagram

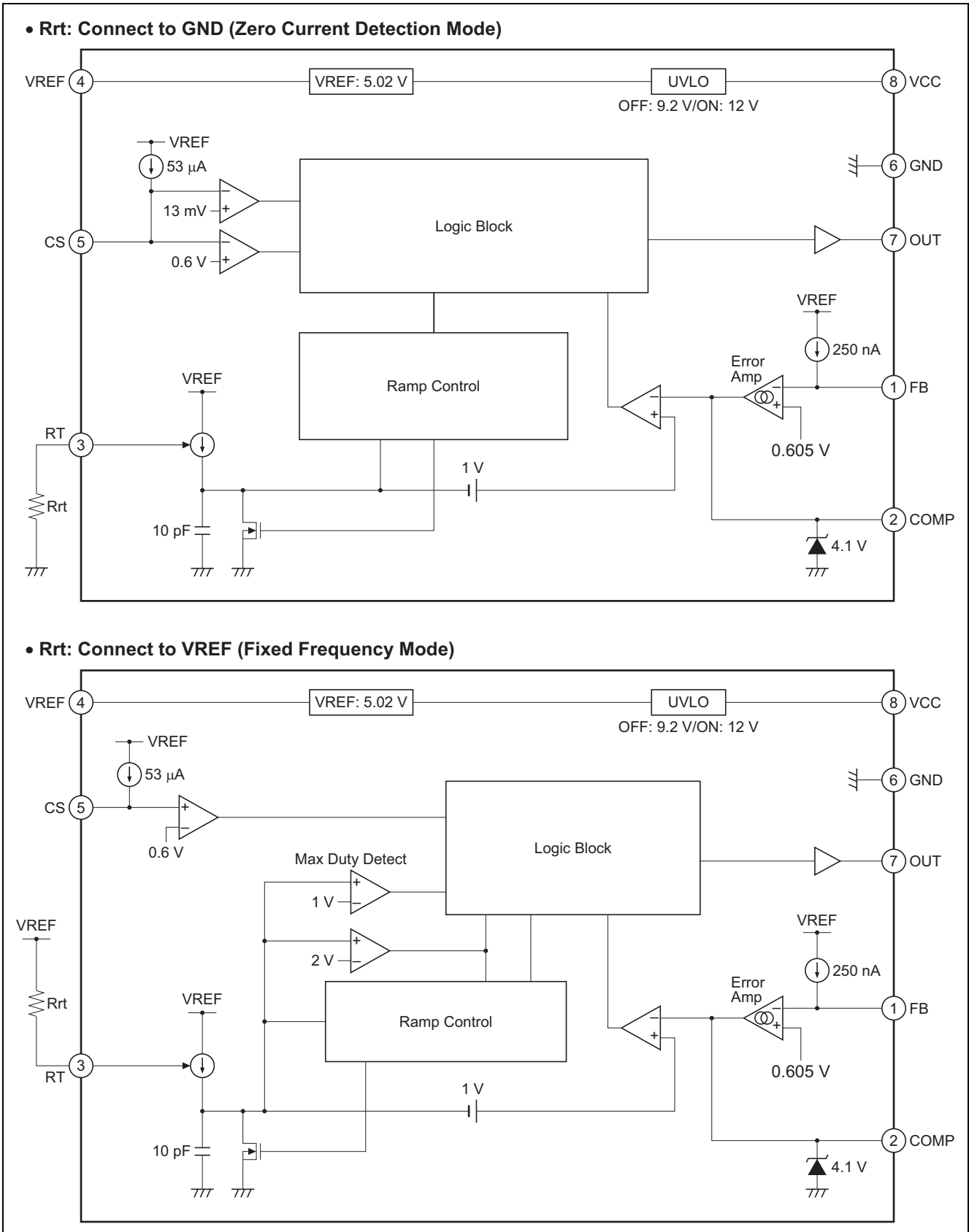

## Absolute Maximum Ratings

(Ta = 25°C)

Item	Symbol	Ratings	Unit	Note
Power Supply Voltage	VCC	-0.3 to +24	V	
OUT terminal peak current	l <sub>pk-snk-out</sub>	0.9	A	3
	l <sub>pk-src-out</sub>	-0.50		
OUT terminal DC current	l <sub>dc-snk-out</sub>	100	mA	
	l <sub>dc-src-out</sub>	-50		
RT terminal current	I <sub>rt</sub>	-200	μA	
VREF terminal current	I <sub>ref</sub>	-5	mA	
Vref terminal voltage	V <sub>t-ref</sub>	-0.3 to V <sub>ref</sub> + 0.3	V	
FB terminal voltage	V <sub>t-fb</sub>	-0.3 to +5	V	
CS terminal voltage	V <sub>cs</sub>	-0.3 to +5	V	
Power dissipation	P <sub>t</sub>	0.68	W	4
Operating ambient temperature	T <sub>a-opr</sub>	-40 to +125	°C	
Junction temperature	T <sub>j</sub>	-40 to +150	°C	5
Storage temperature	T <sub>stg</sub>	-55 to +150	°C	

- Notes:
- Rated voltages are with reference to the GND terminal.
  - For rated currents, inflow to the IC is indicated by (+), and outflow by (-).
  - Shows the transient current when driving a capacitive load.
  - In case of R2A20134SP:  $\theta_{ja} = 120^{\circ}\text{C}/\text{W}$   
This value is a thing mounting on  $40 \times 40 \times 1.6$  [mm], a glass epoxy board of wiring density 10%.
  - Stresses exceeding the absolute maximum ratings may damage the device.  
These are stress ratings only. Functional operation above the recommended operating ambient temperature range is not implied.  
Extended exposure to stresses above the absolute maximum ratings may affect device reliability.

## Electrical Characteristics

(Ta = 25°C, VCC = 15 V, CS = 0 V, FB = COMP, RRT = 200 kΩ)

	Item	Symbol	Min	Typ	Max	Unit	Test Conditions
Supply	UVLO turn-on threshold	Vuvlh	11.2	12	12.8	V	
	UVLO turn-off threshold	Vuvll	8.5	9.2	9.9	V	
	UVLO hysteresis	Hysuvl	2.1	2.8	3.5	V	
	Standby current	Istby	—	130	250	μA	VCC = Vuvlh – 0.2 V
	Operating current	Icc	—	2.2	3.3	mA	
VREF	Reference voltage	Vref	4.945	5.020	5.095	V	Isource = 0 mA
	Temperature stability	dVref	—	±80	—	ppm/°C	Tj = –40 to 150°C *1
	Line regulation	Vref-line	—	5	20	mV	Isource = 0 mA Vcc = 10 V to 24 V
	Load regulation	Vref-load	—	5	20	mV	Isource = 0 mA to –5 mA
Error amplifier	Feedback voltage	Vfb	0.587	0.605	0.623	V	
	Input bias current	Ifb	–0.75	–0.25	–0.1	μA	Measured pin: FB
	Open loop gain	Av	—	63	—	dB	
	Upper clamp voltage	Vclamp_comp	3.85	4.10	4.30	V	FB = 0.3 V COMP: Open
	Low voltage	VI-comp	—	0.1	0.3	V	FB = 0.9 V COMP: Open
	Source current	Isrc-comp	–13	–9.5	–6	μA	FB = 0.3 V COMP: 2.5 V
	Sink current	Isnk-comp	6	9.5	13	μA	FB = 0.9 V COMP: 2.5 V
	Transconductance	gm	25	45	70	μs	FB = 0.55 V ↔ 0.65 V COMP: 2.5 V
RT	RAMP offset voltage	Voffset_ramp	—	1.0	—	V	
	RAMP amplitude	dVramp	2.9	3.1	3.3	V	*2
	RT voltage1	V-rt1	1.9	2.0	2.1	V	RT-GND: 200 kΩ
	RT voltage2	V-rt2	2.9	3.0	3.1	V	RT-Vref: 200 kΩ
Zero current detector	ZCD threshold voltage	Vzcd	7	13	19	mV	
	Input bias current	Ics	–85	–53	–25	μA	Vcs = 13 mV
Restart	Restart time delay	Tstart	45	75	140	μs	FB = 0.3 V, COMP = 2.5 V

Notes: \*1 Design spec

\*2 dVramp = Vclamp\_comp – Voff\_ramp

## Electrical Characteristics (cont.)

(Ta = 25°C, VCC = 15 V, CS = 0 V, FB = COMP, RRT = 200 kΩ)

Item		Symbol	Min	Typ	Max	Unit	Test Conditions
OUT	Rise time	tr-out	—	30	100	ns	CL = 1000 pF, FB = 0.3 V, COMP = 2.5 V
	Fall time	tf-out	—	30	100	ns	CL = 1000 pF, FB = 0.3 V, COMP = 2.5 V
	OUT low voltage	Vol1-out	—	0.08	0.20	V	Isink = 20 mA
		Vol2-out	—	0.05	0.70	V	Isink = 10 mA, VCC = 5 V
	OUT high voltage	Voh-out	14.5	14.8	—	V	Isource = -20 mA *1
	OUT frequency	fout	43	48	53	kHz	RT-Vref: 200 kΩ *3
Maximum duty cycle	Dmax	47	52	57	%	RT-Vref: 200 kΩ	
Over current protection	OCP threshold voltage	Vocp	0.57	0.6	0.63	V	
	OCP blanking time	tblank	170	300	450	ns	

Notes: \*1 Design spec

\*3 The fout is adjusted by changing resistance of Rrt connected between RT-VREF terminals. Reference data and a calculating formula are shown as follows.

$$f_{out} [\text{kHz}] = \frac{1}{(100 \times 10^{-9} \times R_{rt}) + (450 \times 10^{-6})}$$

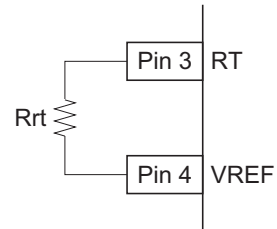
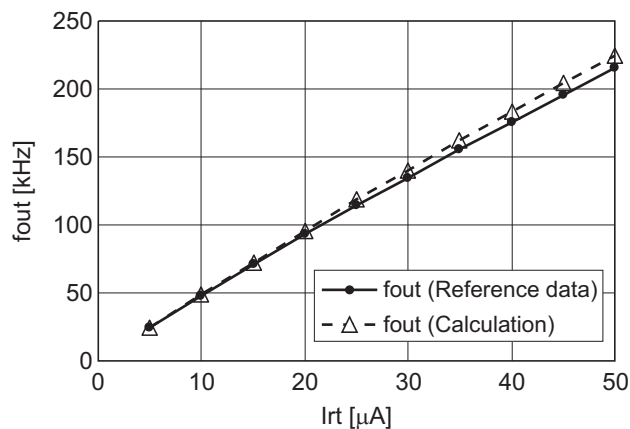

\* The graph is for reference only and does not guarantee actual characteristic.

## Waveforms

### 1. Start-up Timing (Zero Current Detection Mode/Fixed Frequency Mode common)

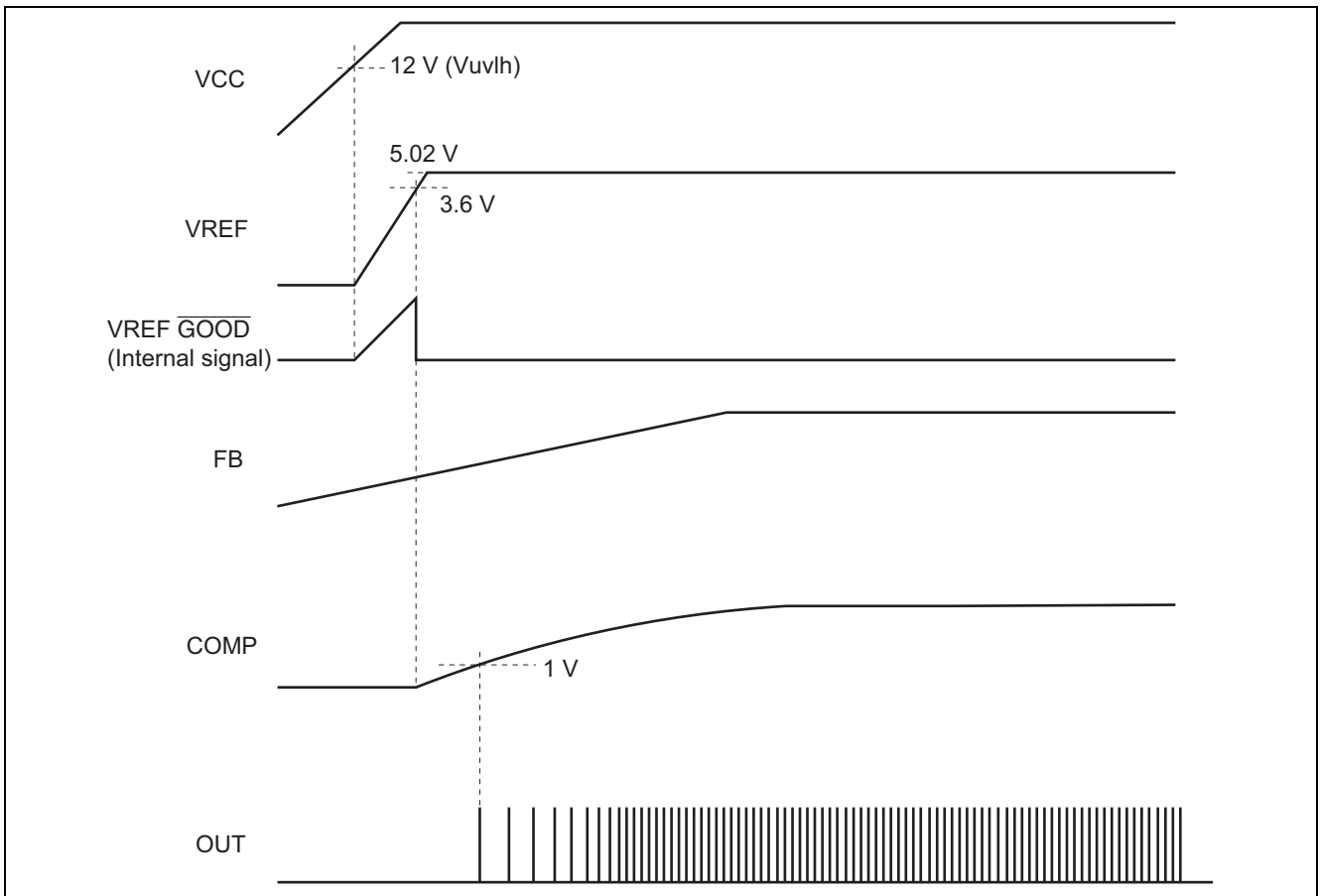

### 2. Stop Timing (Zero Current Detection Mode/Fixed Frequency Mode common)

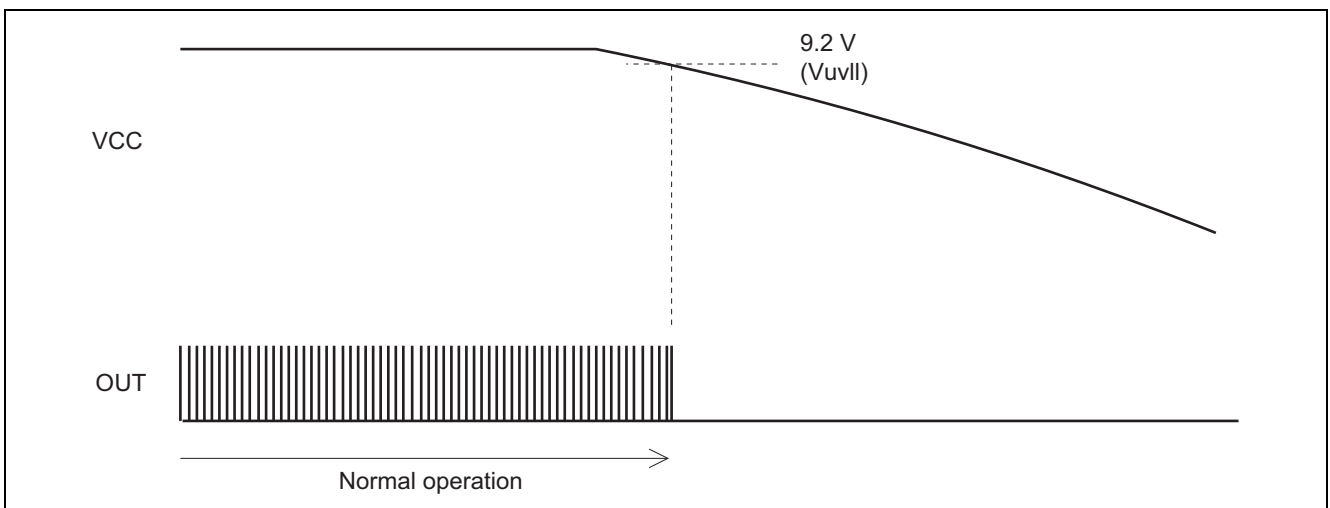

### 3. Gate Drive Output (Zero Current Detection Mode)

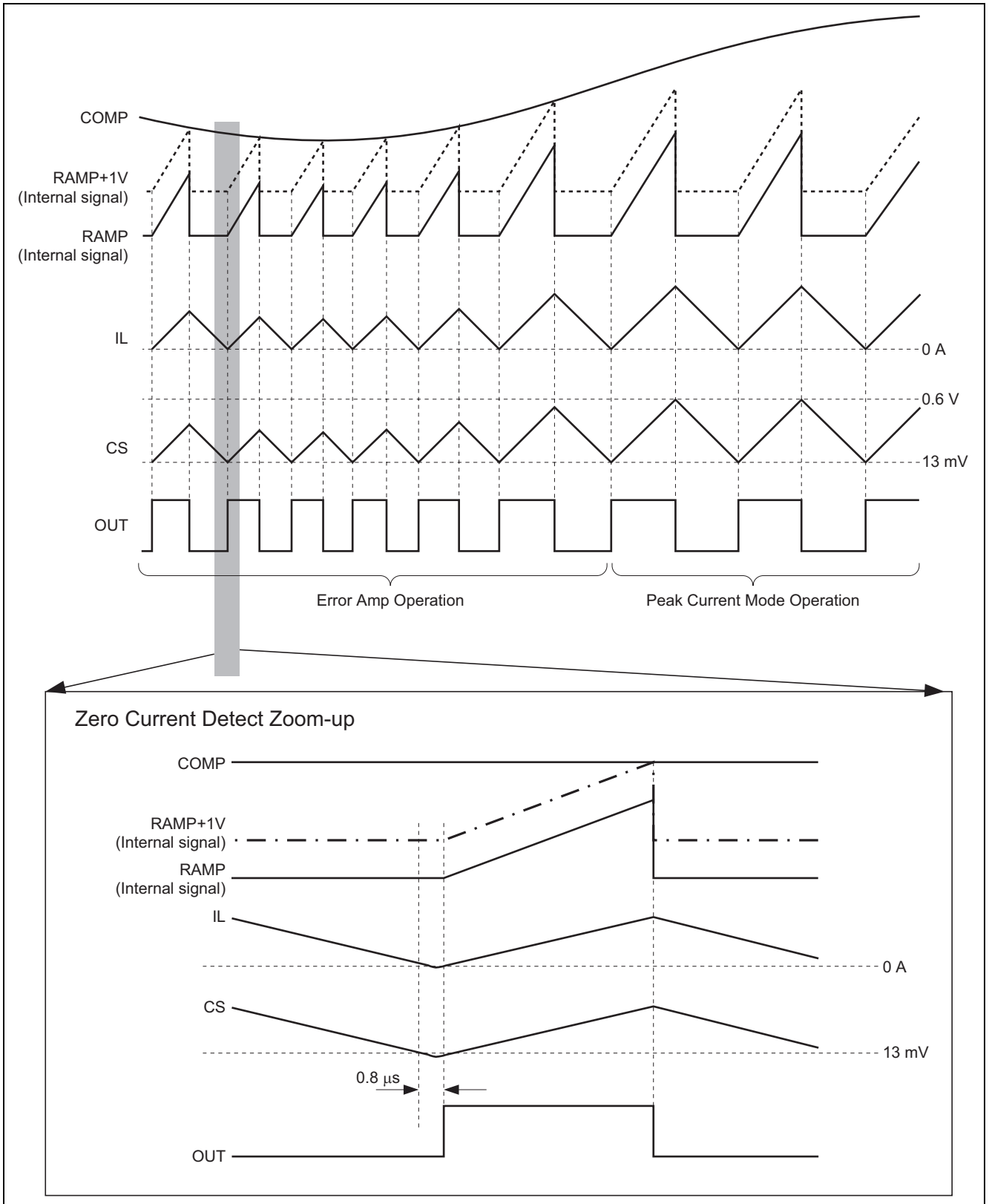



### 4. Gate Drive Output (Fixed Frequency Mode)

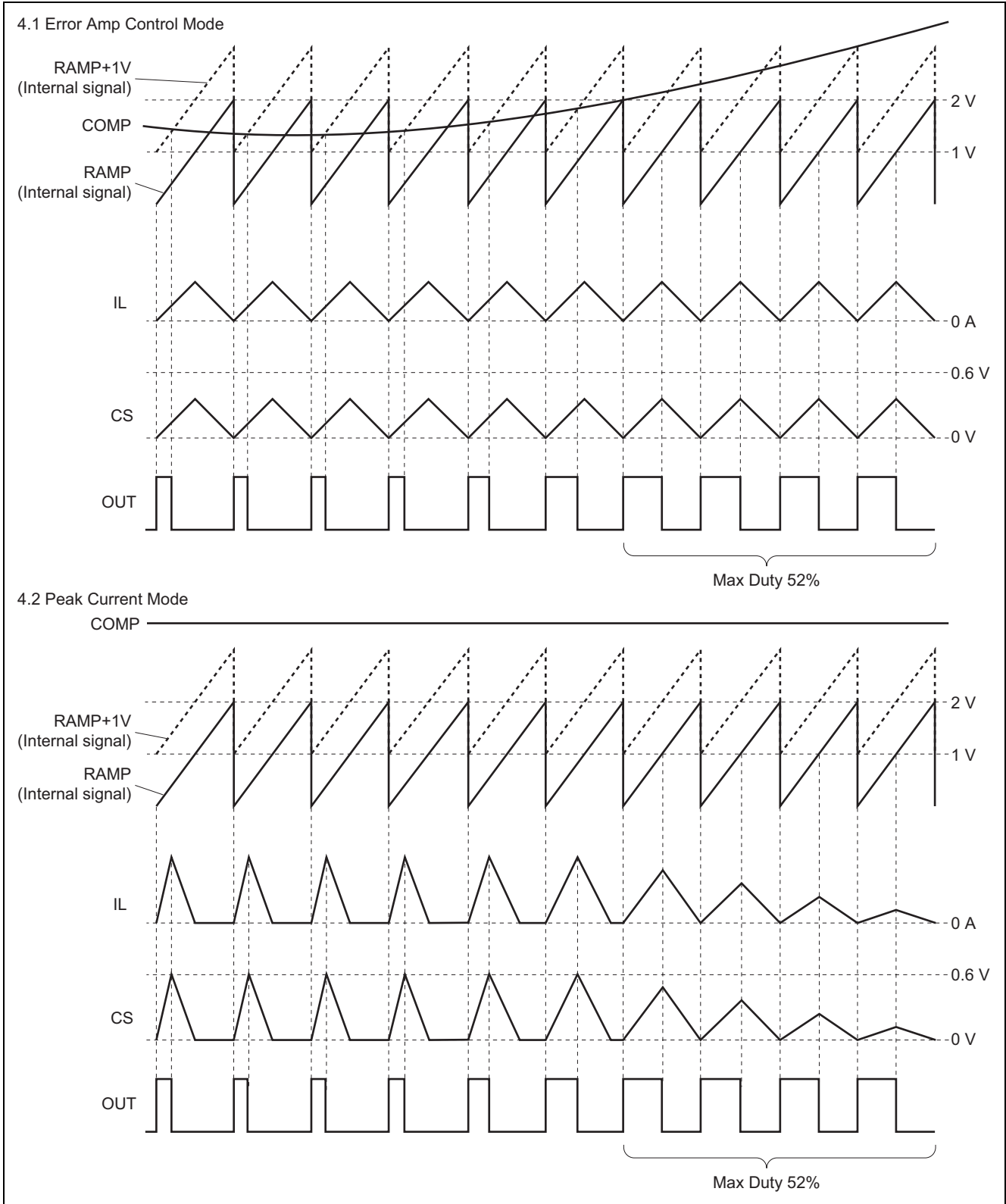

### Package Dimensions

JEITA Package Code	RENESAS Code	Previous Code	MASS[Typ.]
P-SOP8-3.94x4.93-1.27	PRSP0008DJ-A	—	0.073g

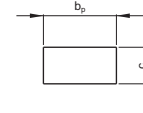
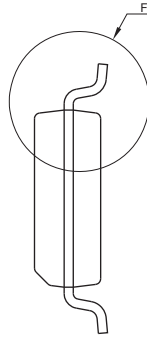
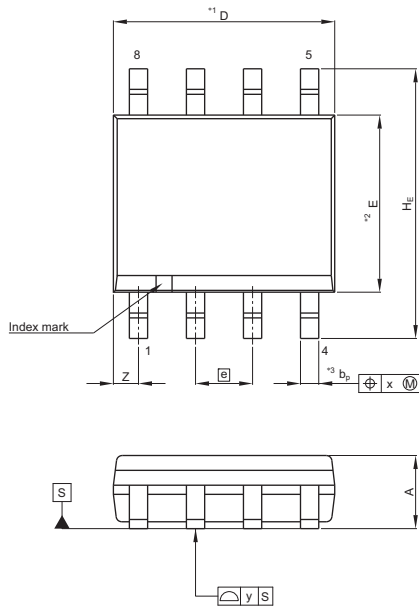

Terminal cross section  
(Ni/Pd/Au plating)

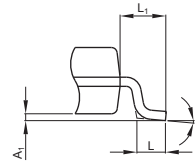

Detail F

NOTE)  
1. DIMENSIONS\*1 (Nom)\*AND\*2\*  
DO NOT INCLUDE MOLD FLASH.  
2. DIMENSION\*3\*DOES NOT  
INCLUDE TRIM OFFSET.

Reference Symbol	Dimension in Millimeters		
	Min	Nom	Max
D	4.80	4.93	4.98
E	3.81	3.94	3.99
A <sub>2</sub>	—	1.47	—
A <sub>1</sub>	0.10	0.15	0.25
A	—	—	1.73
b <sub>p</sub>	0.35	0.41	0.49
b <sub>1</sub>	—	—	—
c	0.19	0.20	0.25
c <sub>1</sub>	—	—	—
$\theta$	0°	—	8°
H <sub>E</sub>	5.84	5.99	6.20
e	—	1.27	—
x	—	—	0.25
y	—	—	0.10
Z	—	0.56	—
L	0.41	0.64	0.89
L <sub>1</sub>	—	1.03	—

## Notice

1. Descriptions of circuits, software and other related information in this document are provided only to illustrate the operation of semiconductor products and application examples. You are fully responsible for the incorporation of these circuits, software, and information in the design of your equipment. Renesas Electronics assumes no responsibility for any losses incurred by you or third parties arising from the use of these circuits, software, or information.
2. Renesas Electronics has used reasonable care in preparing the information included in this document, but Renesas Electronics does not warrant that such information is error free. Renesas Electronics assumes no liability whatsoever for any damages incurred by you resulting from errors in or omissions from the information included herein.
3. Renesas Electronics does not assume any liability for infringement of patents, copyrights, or other intellectual property rights of third parties by or arising from the use of Renesas Electronics products or technical information described in this document. No license, express, implied or otherwise, is granted hereby under any patents, copyrights or other intellectual property rights of Renesas Electronics or others.
4. You should not alter, modify, copy, or otherwise misappropriate any Renesas Electronics product, whether in whole or in part. Renesas Electronics assumes no responsibility for any losses incurred by you or third parties arising from such alteration, modification, copy or otherwise misappropriation of Renesas Electronics product.
5. Renesas Electronics products are classified according to the following two quality grades: "Standard" and "High Quality". The recommended applications for each Renesas Electronics product depends on the product's quality grade, as indicated below.  
"Standard": Computers; office equipment; communications equipment; test and measurement equipment; audio and visual equipment; home electronic appliances; machine tools; personal electronic equipment; and industrial robots etc.  
"High Quality": Transportation equipment (automobiles, trains, ships, etc.); traffic control systems; anti-disaster systems; anti-crime systems; and safety equipment etc.  
Renesas Electronics products are neither intended nor authorized for use in products or systems that may pose a direct threat to human life or bodily injury (artificial life support devices or systems, surgical implantations etc.), or may cause serious property damages (nuclear reactor control systems, military equipment etc.). You must check the quality grade of each Renesas Electronics product before using it in a particular application. You may not use any Renesas Electronics product for any application for which it is not intended. Renesas Electronics shall not be in any way liable for any damages or losses incurred by you or third parties arising from the use of any Renesas Electronics product for which the product is not intended by Renesas Electronics.
6. You should use the Renesas Electronics products described in this document within the range specified by Renesas Electronics, especially with respect to the maximum rating, operating supply voltage range, movement power voltage range, heat radiation characteristics, installation and other product characteristics. Renesas Electronics shall have no liability for malfunctions or damages arising out of the use of Renesas Electronics products beyond such specified ranges.
7. Although Renesas Electronics endeavors to improve the quality and reliability of its products, semiconductor products have specific characteristics such as the occurrence of failure at a certain rate and malfunctions under certain use conditions. Further, Renesas Electronics products are not subject to radiation resistance design. Please be sure to implement safety measures to guard them against the possibility of physical injury, and injury or damage caused by fire in the event of the failure of a Renesas Electronics product, such as safety design for hardware and software including but not limited to redundancy, fire control and malfunction prevention, appropriate treatment for aging degradation or any other appropriate measures. Because the evaluation of microcomputer software alone is very difficult, please evaluate the safety of the final products or systems manufactured by you.
8. Please contact a Renesas Electronics sales office for details as to environmental matters such as the environmental compatibility of each Renesas Electronics product. Please use Renesas Electronics products in compliance with all applicable laws and regulations that regulate the inclusion or use of controlled substances, including without limitation, the EU RoHS Directive. Renesas Electronics assumes no liability for damages or losses occurring as a result of your noncompliance with applicable laws and regulations.
9. Renesas Electronics products and technology may not be used for or incorporated into any products or systems whose manufacture, use, or sale is prohibited under any applicable domestic or foreign laws or regulations. You should not use Renesas Electronics products or technology described in this document for any purpose relating to military applications or use by the military, including but not limited to the development of weapons of mass destruction. When exporting the Renesas Electronics products or technology described in this document, you should comply with the applicable export control laws and regulations and follow the procedures required by such laws and regulations.
10. It is the responsibility of the buyer or distributor of Renesas Electronics products, who distributes, disposes of, or otherwise places the product with a third party, to notify such third party in advance of the contents and conditions set forth in this document, Renesas Electronics assumes no responsibility for any losses incurred by you or third parties as a result of unauthorized use of Renesas Electronics products.
11. This document may not be reproduced or duplicated in any form, in whole or in part, without prior written consent of Renesas Electronics.
12. Please contact a Renesas Electronics sales office if you have any questions regarding the information contained in this document or Renesas Electronics products, or if you have any other inquiries.

(Note 1) "Renesas Electronics" as used in this document means Renesas Electronics Corporation and also includes its majority-owned subsidiaries.

(Note 2) "Renesas Electronics product(s)" means any product developed or manufactured by or for Renesas Electronics.



### SALES OFFICES

Renesas Electronics Corporation

<http://www.renesas.com>

Refer to "<http://www.renesas.com/>" for the latest and detailed information.

#### Renesas Electronics America Inc.

2801 Scott Boulevard Santa Clara, CA 95050-2549, U.S.A.  
Tel: +1-408-588-6000, Fax: +1-408-588-6130

#### Renesas Electronics Canada Limited

9251 Yonge Street, Suite 8309 Richmond Hill, Ontario Canada L4C 9T3  
Tel: +1-905-237-2004

#### Renesas Electronics Europe Limited

Dukes Meadow, Millboard Road, Bourne End, Buckinghamshire, SL8 5FH, U.K.  
Tel: +44-1628-585-100, Fax: +44-1628-585-900

#### Renesas Electronics Europe GmbH

Arcadiastrasse 10, 40472 Düsseldorf, Germany  
Tel: +49-211-6503-0, Fax: +49-211-6503-1327

#### Renesas Electronics (China) Co., Ltd.

Room 1709, Quantum Plaza, No.27 ZhiChunLu Haidian District, Beijing 100191, P.R.China  
Tel: +86-10-8235-1155, Fax: +86-10-8235-7679

#### Renesas Electronics (Shanghai) Co., Ltd.

Unit 301, Tower A, Central Towers, 555 Langao Road, Putuo District, Shanghai, P. R. China 200333  
Tel: +86-21-2226-0888, Fax: +86-21-2226-0999

#### Renesas Electronics Hong Kong Limited

Unit 1601-1611, 16/F., Tower 2, Grand Century Place, 193 Prince Edward Road West, Mongkok, Kowloon, Hong Kong  
Tel: +852-2265-6688, Fax: +852 2886-9022

#### Renesas Electronics Taiwan Co., Ltd.

13F, No. 363, Fu Shing North Road, Taipei 10543, Taiwan  
Tel: +886-2-8175-9600, Fax: +886 2-8175-9670

#### Renesas Electronics Singapore Pte. Ltd.

80 Bendemeer Road, Unit #06-02 Hyflux Innovation Centre, Singapore 339949  
Tel: +65-6213-0200, Fax: +65-6213-0300

#### Renesas Electronics Malaysia Sdn.Bhd.

Unit 1207, Block B, Menara Amcorp, Amcorp Trade Centre, No. 18, Jln Persiaran Barat, 46050 Petaling Jaya, Selangor Darul Ehsan, Malaysia  
Tel: +60-3-7955-9390, Fax: +60-3-7955-9510

#### Renesas Electronics India Pvt. Ltd.

No.77C, 100 Feet Road, HAL II Stage, Indiranagar, Bangalore, India  
Tel: +91-80-67208700, Fax: +91-80-67208777

#### Renesas Electronics Korea Co., Ltd.

12F., 234 Teheran-ro, Gangnam-Gu, Seoul, 135-080, Korea  
Tel: +82-2-558-3737, Fax: +82-2-558-5141

# Mouser Electronics

Authorized Distributor

Click to View Pricing, Inventory, Delivery & Lifecycle Information:

[Renesas Electronics:](#)

[R2A20134SP#W5](#)

Компания «Life Electronics» занимается поставками электронных компонентов импортного и отечественного производства от производителей и со складов крупных дистрибьюторов Европы, Америки и Азии.

С конца 2013 года компания активно расширяет линейку поставок компонентов по направлению коаксиальный кабель, кварцевые генераторы и конденсаторы (керамические, пленочные, электролитические), за счёт заключения дистрибьюторских договоров

Мы предлагаем:

- Конкурентоспособные цены и скидки постоянным клиентам.
- Специальные условия для постоянных клиентов.
- Подбор аналогов.
- Поставку компонентов в любых объемах, удовлетворяющих вашим потребностям.
- Приемлемые сроки поставки, возможна ускоренная поставка.
- Доставку товара в любую точку России и стран СНГ.
- Комплексную поставку.
- Работу по проектам и поставку образцов.
- Формирование склада под заказчика.
- Сертификаты соответствия на поставляемую продукцию (по желанию клиента).
- Тестирование поставляемой продукции.
- Поставку компонентов, требующих военную и космическую приемку.
- Входной контроль качества.
- Наличие сертификата ISO.

В составе нашей компании организован Конструкторский отдел, призванный помогать разработчикам, и инженерам.

Конструкторский отдел помогает осуществить:

- Регистрацию проекта у производителя компонентов.
- Техническую поддержку проекта.
- Защиту от снятия компонента с производства.
- Оценку стоимости проекта по компонентам.
- Изготовление тестовой платы монтаж и пусконаладочные работы.



Тел: +7 (812) 336 43 04 (многоканальный)  
Email: [org@lifeelectronics.ru](mailto:org@lifeelectronics.ru)