

PRODUCT NUMBER	PLATING PERFORMANCE LEVEL	FOR REAR PLUG-UP APPLICATIONS USE SHROUD
10114820-1YYY	TELCORDIA CO	74993-102
10114820-1YYYYLF	TELCORDIA CO	74993-102LF

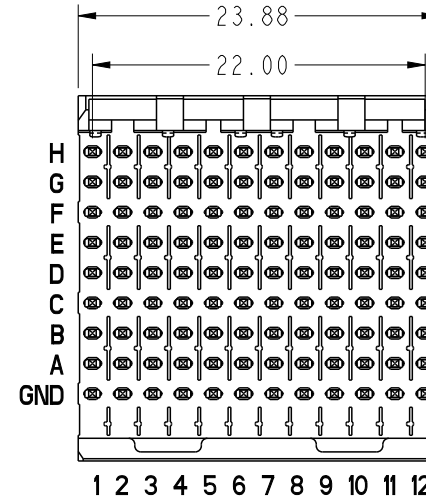

DETAIL A
SCALE 4:1
SEE NOTE 16

SEE DETAIL A

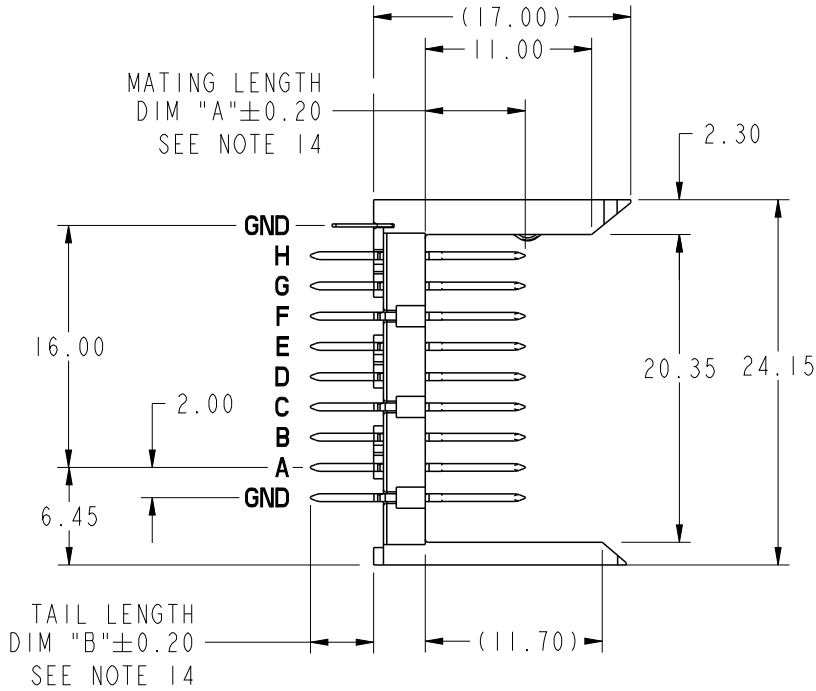
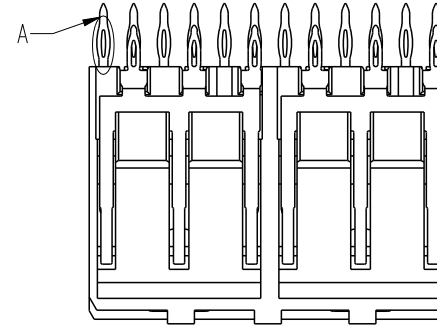

spec ref -		dr P-Mathew Nebu	2012/05/11	projection 	MM 	size A4	scale 2:1
tolerance std ISO 406 ISO 1101		eng Stalin Alosius	2018/03/14			ecn no ELX-I-29544-1	
TOLERANCES UNLESS OTHERWISE SPECIFIED		chr -	-			rel level Released	
surface -	linear	0.X ±0.3	Amphenol FCi	product family METRAL 1000		dwg no 10114820	rev B
		0.XX ±0.13		VERTICAL SIGNAL HDR 8 ROW			
		0.XXX ±0.051		P.F. 96 POS. SELECT LOAD EXT.			
ISO 1302	angular	0° ±2°	cat. no. -	Product - Customer Drw		sheet 1 of 7	



PIN NO.	DIM A MATING LENGTH	DIM B TAIL LENGTH	PCB THICKNESS RANGE ACCOMMODATED BY PIN'S TAIL LENGTH				
			WHEN MATING TO A 74981 SERIES RECEPTACLE		WHEN MATING TO A 52066 SERIES METRAL 4000 RECEPTACLE		
			ROWS A,B, C,D,E,F,G & H	GROUND ROW	ROWS A,B, D,E,G & H	ROW C & F	GROUND ROW
01*	5.00	4.30	1.60 MIN	1.60 MIN	1.60 MIN	1.60 MIN	1.60 MIN
22		12.20	2.95 - 3.80	2.95 - 4.20	2.95 - 3.80	2.95 - 3.80	2.95 - 4.20
30		12.95	2.95 - 4.55	3.25 - 4.95	2.95 - 4.55	2.95 - 4.55	3.25 - 4.95
05		13.70	2.95 - 5.30	4.00 - 5.70	3.30 - 5.30	2.95 - 5.30	4.00 - 5.70
35		14.45	3.05 - 6.05	4.75 - 6.45	4.05 - 6.05	3.05 - 6.05	4.75 - 6.45
48		15.20	3.80 - 6.80	5.50 - 7.20	4.80 - 6.80	3.80 - 6.80	5.50 - 7.20
40		15.70	4.30 - 7.30	6.00 - 7.70	5.30 - 7.30	4.30 - 7.30	6.00 - 7.70
65		16.40	5.00 - 8.00	6.70 - 8.40	6.00 - 8.00	5.00 - 8.00	6.70 - 8.40
09		17.10	5.70 - 8.70	7.40 - 9.10	6.70 - 8.70	5.70 - 8.70	7.40 - 9.10
02*	5.75	4.30	1.60 MIN	1.60 MIN	1.60 MIN	1.60 MIN	1.60 MIN
44		12.20	2.95 - 3.80	2.95 - 4.20	2.95 - 3.80	2.95 - 3.80	2.95 - 4.20
31		12.95	2.95 - 4.55	3.25 - 4.95	2.95 - 4.55	2.95 - 4.55	3.25 - 4.95
06		13.70	2.95 - 5.30	4.00 - 5.70	3.30 - 5.30	2.95 - 5.30	4.00 - 5.70
36		14.45	3.05 - 6.05	4.75 - 6.45	4.05 - 6.05	3.05 - 6.05	4.75 - 6.45
49		15.20	3.80 - 6.80	5.50 - 7.20	4.80 - 6.80	3.80 - 6.80	5.50 - 7.20
25		15.70	4.30 - 7.30	6.00 - 7.70	5.30 - 7.30	4.30 - 7.30	6.00 - 7.70
66		16.40	5.00 - 8.00	6.70 - 8.40	6.00 - 8.00	5.00 - 8.00	6.70 - 8.40
10		17.10	5.70 - 8.70	7.40 - 9.10	6.70 - 8.70	5.70 - 8.70	7.40 - 9.10
03*	6.50	4.30	1.60 MIN	1.60 MIN	1.60 MIN	1.60 MIN	1.60 MIN
45		12.20	2.95 - 3.80	2.95 - 4.20	2.95 - 3.80	2.95 - 3.80	2.95 - 4.20
32		12.95	2.95 - 4.55	3.25 - 4.95	2.95 - 4.55	2.95 - 4.55	3.25 - 4.95
07		13.70	2.95 - 5.30	4.00 - 5.70	3.30 - 5.30	2.95 - 5.30	4.00 - 5.70
37		14.45	3.05 - 6.05	4.75 - 6.45	4.05 - 6.05	3.05 - 6.05	4.75 - 6.45
50		15.20	3.80 - 6.80	5.50 - 7.20	4.80 - 6.80	3.80 - 6.80	5.50 - 7.20
41		15.70	4.30 - 7.30	6.00 - 7.70	5.30 - 7.30	4.30 - 7.30	6.00 - 7.70
24		16.40	5.00 - 8.00	6.70 - 8.40	6.00 - 8.00	5.00 - 8.00	6.70 - 8.40
11		17.10	5.70 - 8.70	7.40 - 9.10	6.70 - 8.70	5.70 - 8.70	7.40 - 9.10

spec ref -		dr P-Mathew Nebu	2012/05/11	projection 	MM 	size A4	scale 2:1	
tolerance std ISO 406 ISO 1101	TOLERANCES UNLESS OTHERWISE SPECIFIED	eng Stalin Alosius	2018/03/14			ecn no ELX-I-29544-1		
		chr -	-					
surface ISO 1302	linear	0.X	±0.3	product family METRAL 1000	rel level Released			
		0.XX	±0.13					
		0.XXX	±0.051					
	angular	0°	±2°	Amphenol FCI		VERTICAL SIGNAL HDR 8 ROW	dwg no 10114820	rev B
				P.F. 96 POS. SELECT LOAD EXT.				
cat. no. -		Product - Customer Drw			sheet 2 of 7			

PIN NO.	DIM A MATING LENGTH	DIM B TAIL LENGTH	PCB THICKNESS RANGE ACCOMMODATED BY PIN LENGTH				
			WHEN MATING TO A 74981 SERIES RECEPTACLE		WHEN MATING TO A 52066 SERIES METRAL 4000 RECEPTACLE		
			ROWS A,B,C, D,E,F,G & H	GROUND ROW	ROWS:A,B, D,E,G & H	ROW C & F	GROUND ROW
04*	7.25	4.30	1.60 MIN	1.60 MIN	1.60 MIN	1.60 MIN	1.60 MIN
46		12.20	2.95 - 3.80	2.95 - 4.20	2.95 - 3.80	2.95 - 3.80	2.95 - 4.20
33		12.95	2.95 - 4.55	3.25 - 4.95	2.95 - 4.55	2.95 - 4.55	3.25 - 4.95
08		13.70	2.95 - 5.30	4.00 - 5.70	3.30 - 5.30	2.95 - 5.30	4.00 - 5.70
38		14.45	3.05 - 6.05	4.75 - 6.45	4.05 - 6.05	3.05 - 6.05	4.75 - 6.45
51		15.20	3.80 - 6.80	5.50 - 7.20	4.80 - 6.80	3.80 - 6.80	5.50 - 7.20
42		15.70	4.30 - 7.30	6.00 - 7.70	5.30 - 7.30	4.30 - 7.30	6.00 - 7.70
67		16.40	5.00 - 8.00	6.70 - 8.40	6.00 - 8.00	5.00 - 8.00	6.70 - 8.40
12		17.10	5.70 - 8.70	7.40 - 9.10	6.70 - 8.70	5.70 - 8.70	7.40 - 9.10
19*	8.00	4.30	1.60 MIN	1.60 MIN	1.60 MIN	1.60 MIN	1.60 MIN
47		12.20	2.95 - 3.80	2.95 - 4.20	2.95 - 3.80	2.95 - 3.80	2.95 - 4.20
34		12.95	2.95 - 4.55	3.25 - 4.95	2.95 - 4.55	2.95 - 4.55	3.25 - 4.95
20		13.70	2.95 - 5.30	4.00 - 5.70	3.30 - 5.30	2.95 - 5.30	4.00 - 5.70
39		14.45	3.05 - 6.05	4.75 - 6.45	4.05 - 6.05	3.05 - 6.05	4.75 - 6.45
52		15.20	3.80 - 6.80	5.50 - 7.20	4.80 - 6.80	3.80 - 6.80	5.50 - 7.20
43		15.70	4.30 - 7.30	6.00 - 7.70	5.30 - 7.30	4.30 - 7.30	6.00 - 7.70
68		16.40	5.00 - 8.00	6.70 - 8.40	6.00 - 8.00	5.00 - 8.00	6.70 - 8.40
21		17.10	5.70 - 8.70	7.40 - 9.10	6.70 - 8.70	5.70 - 8.70	7.40 - 9.10

* STUB PINS - NO REAR PLUG-UP

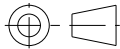
** THE GREATEST RANGE OCCURS WHEN THE B DIMENSION OF PIN 'GND' IS ONE SIZE SHORTER THEN THE OTHER PINS.

spec ref -		dr P-Mathew Nebu	2012/05/11	projection 	MM 	size A4	scale 2:1
tolerance std ISO 406 ISO 1101	TOLERANCES UNLESS OTHERWISE SPECIFIED	eng Stalin Alosius	2018/03/14			ecn no ELX-I-29544-1	
		chr -	-			rel level Released	
surface ISO 1302	linear	0.X	±0.3	product family METRAL 1000	dwg no 10114820	rev B	
		0.XX	±0.13				
		0.XXX	±0.051				
	angular	0°	±2°	cat. no. -	Product - Customer Drw	sheet 3 of 7	

PRODUCT NUMBER
SEE SHEET 1



PRESS-FIT HOLES *	OPTION 1
HOLE DIAMETER AFTER PLATING	Ø 0.65-0.80
DRILLED HOLE	Ø 0.81-0.86 (Ø 0.85 DRILL)
COPPER PLATING	0.025 MIN
SnPb PLATING	0.005-0.015

* SEE PRINT 58351 FOR
ADDITIONAL PCB INFO.

spec ref -		dr P-Mathew Nebu	2012/05/11	projection 	MM ←→	size A4	scale 1:1
tolerance std ISO 406 ISO 1101		eng Stalin Alosius	2018/03/14			ecn no ELX-I-29544-1	
TOLERANCES UNLESS OTHERWISE SPECIFIED		chr -	-			rel level Released	
surface ISO 1302	linear	0.X	±0.3	Amphenol FCi	title VERTICAL SIGNAL HDR 8 ROW P.F. 96 POS. SELECT LOAD EXT.	dwg no 10114820	rev B
		0.XX	±0.13				
	angular	0°	±2°	cat. no.	Product - Customer Drw	sheet 4 of 7	

PRODUCT NUMBER
SEE SHEET 1

NOTES:

1. SEE APPLICATION SPECIFICATION GS-20-010 FOR INFORMATION ON AVAILABLE TOOLING, CIRCUIT BOARD DESIGN CONSIDERATIONS, REPAIR PROCEDURES AND PRODUCT OFFERINGS.
2. SEE FCI PUBLICATION 950511-028 FOR "ELECTRICAL PERFORMANCE DATA FOR DIFFERENTIAL APPLICATIONS."
3. SEE FCI PUBLICATION 950511-028 FOR "ELECTRICAL PERFORMANCE DATA FOR SINGLE-ENDED APPLICATION."
4. UNLESS OTHERWISE SPECIFIED, ALL DIMENSIONS AND TOLERANCES TOLERANCES ARE IN ACCORDANCE WITH ASME Y14.5M, 1994
5. HOUSING MATERIAL: LIQUID CRYSTAL POLYMER, 30% GLASS FILLED, FLAME RETARDANT PER UL 94-V0.
PIN MATERIAL: PHOSPHOR BRONZE
GROUND SPRING MATERIAL: PHOSPHOR BRONZE
6. PLATING INFORMATION: PLATING ON CONTACT AREA MEETS THE PERFORMANCE LEVELS SHOWN IN TABLE ON SHEET 1. PLATING ON "LF" TAILS IS Sn. PLATING ON ALL OTHER TAILS IS SnPb.
7. DIMENSIONAL RESTRICTIONS OF PINS IN HEADERS.
FOR MATING WITH METRAL 1000 RECEPTACLES
DIM A : 5.00mm MIN, 8.00mm MAX FOR ROWS A-H
DIM A : 5.00mm MIN, 5.75mm MAX FOR ROW GND NEXT TO ROW A
DIM C : 5.00mm MIN, 8.00mm MAX FOR ROWS A-H
DIM C : 4.60mm MIN, 6.30mm MAX FOR ROW GND NEXT TO ROW A
FOR MATING WITH METRAL 4000 RECEPTACLES
DIM A : 5.00mm MIN, 6.50mm MAX FOR ROWS A, B, D, E, G & H
DIM A : 5.00mm MIN, 8.00mm MAX FOR ROW C & F
DIM A : 5.00mm MIN, 5.75mm MAX FOR ROW GND NEXT TO ROW A
DIM C : 5.00mm MIN, 7.00mm MAX FOR ROWS A, B, D, E, G & H
DIM C : 5.00mm MIN, 8.00mm MAX FOR ROW C & F
DIM C : 4.60mm MIN, 6.30mm MAX FOR ROW GND NEXT TO ROW A
8. THE MIN PCB THICKNESS FOR REAR PLUG-UP APPLICATIONS IS 2.9mm SINCE THE COMPLIANT SECTIONS OF THE GROUND SPRING OF THE HEADER DIRECTLY OPPOSE THE GROUND SPRING OF THE SHROUD. THE MIN PCB THICKNESS FOR FRONT PLUG-UP ONLY APPLICATIONS IS 1.6mm.

9. THESE HOLES ARE NEEDED FOR REAR PLUG-UP DESIGNS USING A SHROUD AND MAY BE OMITTED FOR FRONT PLUG-UP ONLY DESIGNS.
10. THE 'CONNECTOR OUTLINE' IS THE MIN OUTLINE REQUIRED. TO DETERMINE THE OUTLINE NECESSARY TO PERMIT THE VARIOUS TYPES OF REPAIR OPERATIONS, SEE APPLICATION SPECIFICATION GS-20-010.
11. CURRENT RATING : 1 AMP PER PIN
12. TEMPERATURE RANGE : -55°C TO +105°C
13. P/N 10114820-XXXXLF
14. AFTER INSERTION INTO CIRCUIT BOARD WITH QUALIFIED TOOL.
15. PRODUCTS WHERE THE PART NUMBER ENDS IN LF MEET EUROPEAN UNION DIRECTIVES AND OTHER COUNTRY REGULATIONS AS DESCRIBED IN GS-22-008.



LEAD FREE (OPTIONAL)
SELECT LOAD PATTERN
PLATING CODE

- ALL PRODUCTS WILL WITHSTAND EXPOSURE TO 260°C FOR 60 SECONDS IN A CONVECTION, INFRA-RED OR VAPOR PHASE REFLOW OVEN.
16. PIN TYPE IS OF EYE OF THE NEEDLE STYLE

spec ref		-		dr	P-Mathew Nebu	2012/05/11	projection 	MM 	size	A4	scale	1:1		
tolerance std		TOLERANCES UNLESS OTHERWISE SPECIFIED		eng	Stalin Alosius	2018/03/14			ecn no	ELX-I-29544-1				
ISO 406 ISO 1101				chr	-	-			rel level	Released				
surface		linear	0.X	±0.3	Amphenol FCI	part no		VERTICAL SIGNAL HDR 8 ROW		dwg no	10114820		rev	B
			0.XX	±0.13		P.F. 96 POS. SELECT LOAD EXT.								
			0.XXX	±0.051		cat. no.		Product - Customer Drw			sheet 5 of 7			
ISO 1302		angular	0°	±2°										



Amphenol
FCI

© 2016 AFCI

METRAL P/N	ROW	CONTACT CODE											
		1	2	3	4	5	6	7	8	9	10	11	12
10114820-X001 FOR LEAD FREE SEE NOTE 15	H	01	02	02	02	02	02	01	02	02	02	02	03
	G	02	02	02	02	02	02	02	02	02	02	02	03
	F	02	02	02	02	02	02	02	02	02	02	02	03
	E	02	02	02	02	02	02	02	02	02	02	02	03
	D	02	02	02	02	02	02	02	02	02	02	02	03
	C	02	02	02	02	02	02	02	02	02	02	02	03
	B	02	02	02	02	02	02	02	02	02	02	02	03
	A	02	02	02	02	02	02	02	02	02	02	02	03
GND	01	01	01	01	01	01	01	01	01	01	01	01	

METRAL P/N	ROW	CONTACT CODE											
		1	2	3	4	5	6	7	8	9	10	11	12
10114820-X005 FOR LEAD FREE SEE NOTE 15	H	03	03	03	03	03	03	02	02	02	02	02	
	G	03	03	03	03	03	03	02	02	02	02	02	
	F	03	03	03	03	03	03	02	02	02	02	02	
	E	03	03	03	03	03	03	02	02	02	02	02	
	D	03	03	03	03	03	03	02	02	02	02	02	
	C	03	03	03	03	03	03	02	02	02	02	02	
	B	03	03	03	03	03	03	02	02	02	02	02	
	A	03	03	03	03	03	03	02	02	02	02	02	
GND	01	01	01	01	01	01	01	01	01	01	01	01	

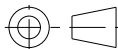
METRAL P/N	ROW	CONTACT CODE											
		1	2	3	4	5	6	7	8	9	10	11	12
10114820-X009 FOR LEAD FREE SEE NOTE 15	H	01	02	02	02	02	02	02	02	02	02	02	
	G	02	02	02	02	02	02	02	02	02	02	02	
	F	02	02	02	02	02	02	02	02	02	02	02	
	E	03	02	02	02	02	02	02	02	02	02	02	
	D	03	02	02	02	02	02	02	02	02	02	02	
	C	03	02	02	02	02	02	02	02	02	02	02	
	B	03	02	02	02	02	02	02	02	02	02	02	
	A	03	02	02	02	02	02	02	02	02	02	02	
GND	01	01	01	01	01	01	01	01	01	01	01	01	

spec ref -		dr	P-Mathew Nebu		2012/05/11		projection 	MM 	size	A4		scale	1:1	
tolerance std		eng	Stalin Alosius		2018/03/14				ecn no	ELX-I-29544-1				
ISO 406 ISO 1101		chr	-		-				rel level	Released				
surface		linear	0.X	±0.3		Amphenol FCI	VERTICAL SIGNAL HDR 8 ROW P.F. 96 POS. SELECT LOAD EXT.	dwg no	10114820			rev	B	
ISO 1302			0.XX	±0.13					cat. no.	Product - Customer Drw			sheet 6 of 7	
			0.XXX	±0.051										
		angular	0°	±2°										

Amphenol
FCI

© 2016 AFCI

METRAL P/N	ROW	CONTACT CODE												
		1	2	3	4	5	6	7	8	9	10	11	12	
10114820-X013 FOR LEAD FREE SEE NOTE 15	H	01	02	02	02	02	02	02	02	02	04	04	03	03
	G	02	02	02	02	02	02	02	02	02	04	04	03	03
	F	02	02	02	02	02	02	02	02	02	04	04	03	03
	E	02	02	02	02	02	02	02	02	02	04	04	04	04
	D	02	02	02	02	02	02	02	02	02	04	04	04	04
	C	02	02	02	02	02	02	02	02	02	04	04	04	04
	B	02	02	02	02	02	02	02	02	02	04	04	04	04
	A	02	02	02	02	02	02	02	02	02	04	04	04	04
	GND	01	01	01	01	01	01	01	01	01	01	01	01	01
METRAL P/N	ROW	CONTACT CODE												
10114820-X014 FOR LEAD FREE SEE NOTE 15	H	02	02	02	02	02	02	02	02	02	02	02	02	02
	G	02	02	02	02	02	02	02	02	02	02	02	02	02
	F	02	02	02	02	02	02	02	02	02	02	02	02	02
	E	02	02	02	02	02	02	02	02	02	02	02	02	02
	D	02	02	02	02	02	02	02	02	02	02	02	02	02
	C	02	02	02	02	02	02	02	02	02	02	02	02	02
	B	02	02	02	02	02	02	02	02	02	02	02	02	02
	A	02	02	02	02	02	02	02	02	02	02	02	02	01
	GND	01	01	01	01	01	01	01	01	01	01	01	01	01
METRAL P/N	ROW	CONTACT CODE												
10114820-X015 FOR LEAD FREE SEE NOTE 15	H	02	02	02	02	02	02	02	02	02	02	02	02	02
	G	02	02	02	02	02	02	02	02	02	02	02	02	02
	F	02	02	02	02	02	02	02	02	02	02	02	02	02
	E	02	02	02	02	02	02	02	02	02	02	02	02	02
	D	06	06	06	06	06	06	06	06	06	06	06	06	06
	C	06	06	06	06	06	06	06	06	06	06	06	06	06
	B	06	06	06	06	06	06	06	06	06	06	06	06	06
	A	06	06	06	06	06	06	06	06	06	06	06	06	06
	GND	05	05	05	05	05	05	05	05	05	05	05	05	05
METRAL P/N	ROW	CONTACT CODE												
10114820-X016 FOR LEAD FREE SEE NOTE 15	H	06	06	06	06	06	06	06	06	06	06	06	06	06
	G	06	06	06	06	06	06	06	06	06	06	06	06	06
	F	06	06	06	06	06	06	06	06	06	06	06	06	06
	E	06	06	06	06	06	06	06	06	06	06	06	06	06
	D	06	06	06	06	06	06	06	06	06	06	06	06	06
	C	06	06	06	06	06	06	06	06	06	06	06	06	06
	B	06	06	06	06	06	06	06	06	06	06	06	06	06
	A	02	02	02	02	06	06	06	06	06	06	06	06	06
	GND	05	05	05	05	05	05	05	05	05	05	05	05	05

spec ref	-		dr	P-Mathew Nebu	2012/05/11	projection 	MM 	size	A4	scale	1:1
tolerance std	TOLERANCES UNLESS OTHERWISE SPECIFIED		eng	Stalin Alosius	2018/03/14			ecn no	ELX-I-29544-1		
ISO 406 ISO 1101			chr	-	-			rel level	Released		
surface	linear	0.X	±0.3	Amphenol FCI	title	VERTICAL SIGNAL HDR 8 ROW P.F. 96 POS. SELECT LOAD EXT.	dwg no	10114820	rev	B	
ISO 1302		0.XX	±0.13								cat. no.
	angular	0°	±2°								

Creo Title - REV E - 2016-02-12

Компания «Life Electronics» занимается поставками электронных компонентов импортного и отечественного производства от производителей и со складов крупных дистрибьюторов Европы, Америки и Азии.

С конца 2013 года компания активно расширяет линейку поставок компонентов по направлению коаксиальный кабель, кварцевые генераторы и конденсаторы (керамические, пленочные, электролитические), за счёт заключения дистрибьюторских договоров

Мы предлагаем:

- Конкурентоспособные цены и скидки постоянным клиентам.
- Специальные условия для постоянных клиентов.
- Подбор аналогов.
- Поставку компонентов в любых объемах, удовлетворяющих вашим потребностям.
- Приемлемые сроки поставки, возможна ускоренная поставка.
- Доставку товара в любую точку России и стран СНГ.
- Комплексную поставку.
- Работу по проектам и поставку образцов.
- Формирование склада под заказчика.
- Сертификаты соответствия на поставляемую продукцию (по желанию клиента).
- Тестирование поставляемой продукции.
- Поставку компонентов, требующих военную и космическую приемку.
- Входной контроль качества.
- Наличие сертификата ISO.

В составе нашей компании организован Конструкторский отдел, призванный помогать разработчикам, и инженерам.

Конструкторский отдел помогает осуществить:

- Регистрацию проекта у производителя компонентов.
- Техническую поддержку проекта.
- Защиту от снятия компонента с производства.
- Оценку стоимости проекта по компонентам.
- Изготовление тестовой платы монтаж и пусконаладочные работы.



Тел: +7 (812) 336 43 04 (многоканальный)

Email: org@lifeelectronics.ru