

## SOT-227 Power Module Insulated Standard Recovery Rectifier, 160 A



SOT-227

**FEATURES**

- Two fully independent diodes
- Fully insulated package
- High voltage rectifiers optimized for very low forward voltage drop
- Industry standard outline
- UL pending
- Material categorization: for definitions of compliance please see [www.vishay.com/doc?99912](http://www.vishay.com/doc?99912)

**RoHS**  
COMPLIANT

**DESCRIPTION / APPLICATIONS**

These devices are intended for use in main rectification. Single or three phase bridge.

**PRIMARY CHARACTERISTICS**

$I_{F(AV)}$ per module	160 A, $T_C = 101\text{ }^\circ\text{C}$
$V_{FM}$ typical at 100 A	1.16 V
Type	Modules - diode, high voltage
Package	SOT-227
Circuit configuration	Two separate diodes, parallel pin-out

**MAJOR RATINGS AND CHARACTERISTICS**

SYMBOL	CHARACTERISTICS	VALUES	UNITS
$I_{F(AV)}$	90 °C	91	A
$I_{F(RMS)}$		138	
$I_{FSM}$	50 Hz	940	
	60 Hz	985	
$I^2t$	50 Hz	4420	A <sup>2</sup> s
	60 Hz	4015	
$I^2\sqrt{t}$		44 180	A <sup>2</sup> √s
$V_{RRM}$		1200	V
$T_J$		-55 to +150	°C

**ELECTRICAL SPECIFICATIONS**
**VOLTAGE RATINGS**

TYPE NUMBER	VOLTAGE CODE	$V_{RRM}$ , MAXIMUM REPETITIVE PEAK REVERSE VOLTAGE V	$V_{RSM}$ , MAXIMUM NON-REPETITIVE PEAK REVERSE VOLTAGE V	$I_{RRM}$ TYPICAL AT 150 °C mA
VS-RA160FA120	120	1200	1300	1.0



FORWARD CONDUCTION					
PARAMETER	SYMBOL	TEST CONDITIONS		VALUES	UNITS
Maximum average forward current at case temperature per leg	$I_{F(AV)}$	180° conduction, half sine wave, 90 °C		91	A
Maximum RMS forward current per leg	$I_{F(RMS)}$	DC at 101 °C case temperature		138	A
Maximum peak, one-cycle forward, non-repetitive surge current per leg	$I_{FSM}$	t = 10 ms	No voltage reapplied	940	
		t = 8.3 ms		985	
		t = 10 ms	100 % $V_{RRM}$ reapplied	790	
		t = 8.3 ms		825	
Maximum $I^2t$ for fusing per leg	$I^2t$	t = 10 ms	No voltage reapplied	4420	A <sup>2</sup> s
		t = 8.3 ms		4015	
		t = 10 ms	100 % $V_{RRM}$ reapplied	3125	
		t = 8.3 ms		2840	
Maximum $I^2\sqrt{t}$ for fusing per leg	$I^2\sqrt{t}$	t = 0.1 ms to 10 ms, no voltage reapplied		44 180	A <sup>2</sup> √s
Low level of threshold voltage per leg	$V_{F(TO)1}$	$(16.7 \% \times \pi \times I_{F(AV)}) < I < \pi \times I_{F(AV)}, T_J = T_J \text{ maximum}$		0.80	V
Low level value of forward slope resistance	$r_{f1}$			4.32	mΩ
High level of threshold voltage per leg	$V_{F(TO)2}$	$(I > \pi \times I_{F(AV)}), T_J = T_J \text{ maximum}$		0.93	V
High level value of forward slope resistance	$r_{f2}$			4.14	mΩ
Maximum forward voltage drop per leg	$V_{FM}$	$I_{FM} = 100 \text{ A}, T_J = 25 \text{ °C}$		1.27	V
		$I_{FM} = 100 \text{ A}, T_J = 150 \text{ °C}$		1.22	

BLOCKING					
PARAMETER	SYMBOL	TEST CONDITIONS		VALUES	UNITS
Maximum peak reverse leakage current per leg	$I_{RRM}$	$T_J = 25 \text{ °C}$		150	μA
		$T_J = 150 \text{ °C}$		1.5	mA
RMS insulation voltage	$V_{INS}$	$T_J = 25 \text{ °C}$ , any terminal to case, t = 1 minute		2500	V

THERMAL - MECHANICAL SPECIFICATIONS						
PARAMETER	SYMBOL	MIN.	TYP.	MAX.	UNITS	
Thermal resistance, junction to case	per leg	-	-	0.26	°C/W	
	per module	-	-	0.13		
Thermal resistance, case to heatsink	per module	-	0.1	-		
Weight		-	30	-	g	
Mounting torque to terminal		-	-	1.1 (9.7)	Nm (lbf. in)	
Mounting torque to heatsink		-	-	1.8 (15.9)	Nm (lbf. in)	
Case style		SOT-227				

ΔR CONDUCTION PER JUNCTION											
DEVICE	SINE HALF WAVE CONDUCTION					RECTANGULAR WAVE CONDUCTION					UNITS
	180°	120°	90°	60°	30°	180°	120°	90°	60°	30°	
VS-RA160FA120	0.109	0.122	0.149	0.213	0.355	0.069	0.119	0.159	0.223	0.358	°C/W

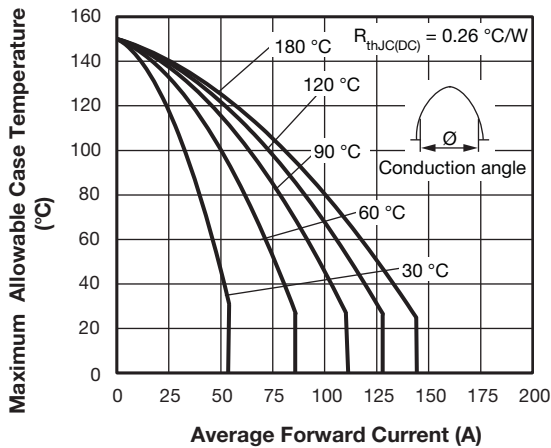

Fig. 1 - Current Ratings Characteristics (A)

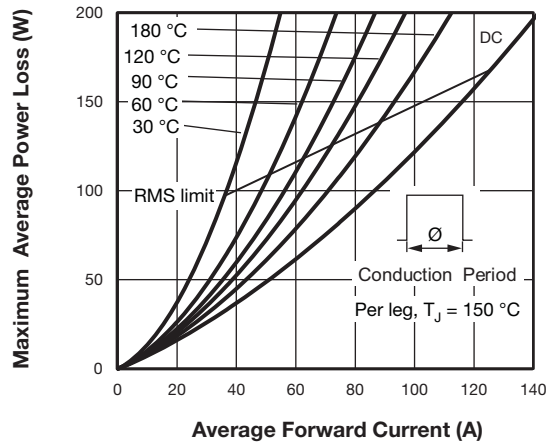

Fig. 4 - Forward Power Loss Characteristics

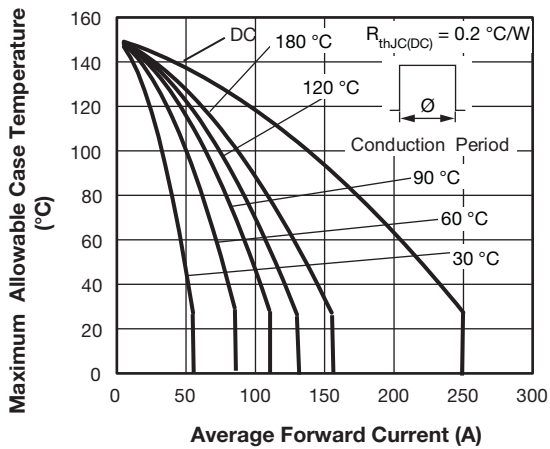

Fig. 2 - Current Ratings Characteristics (A)

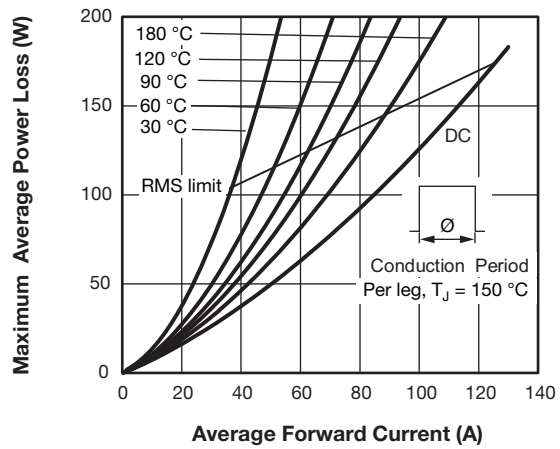

Fig. 5 - Forward Power Loss Characteristics

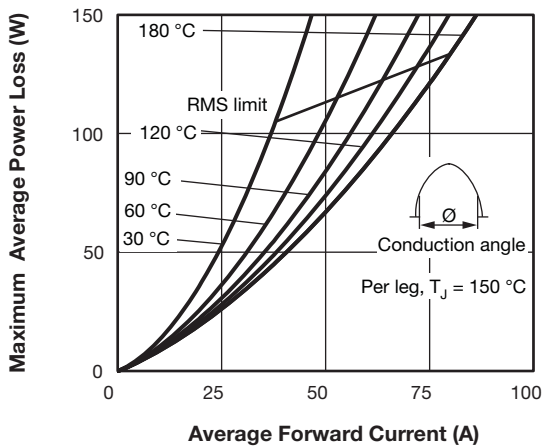

Fig. 3 - Current Ratings Characteristics (A)

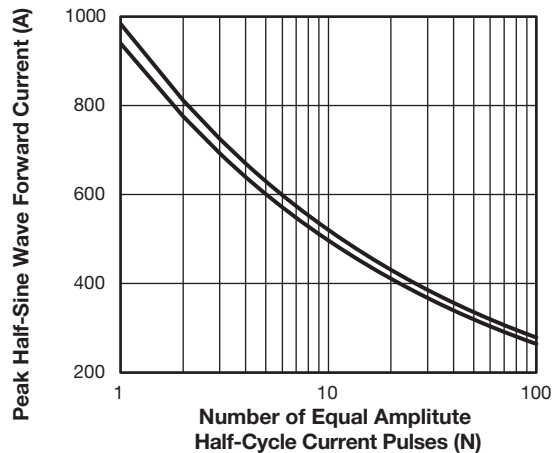

Fig. 6 - Maximum Non-Repetitive Surge Current

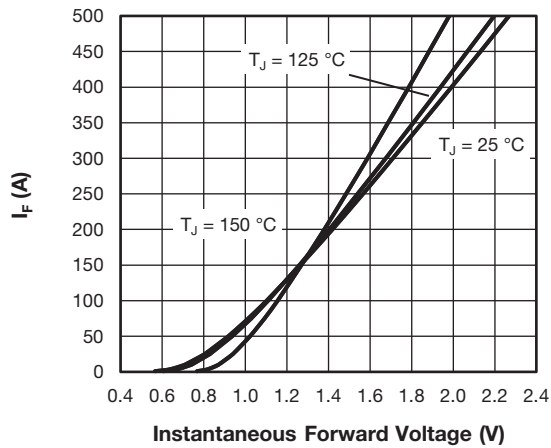

Fig. 7 - Typical Forward Voltage Characteristics

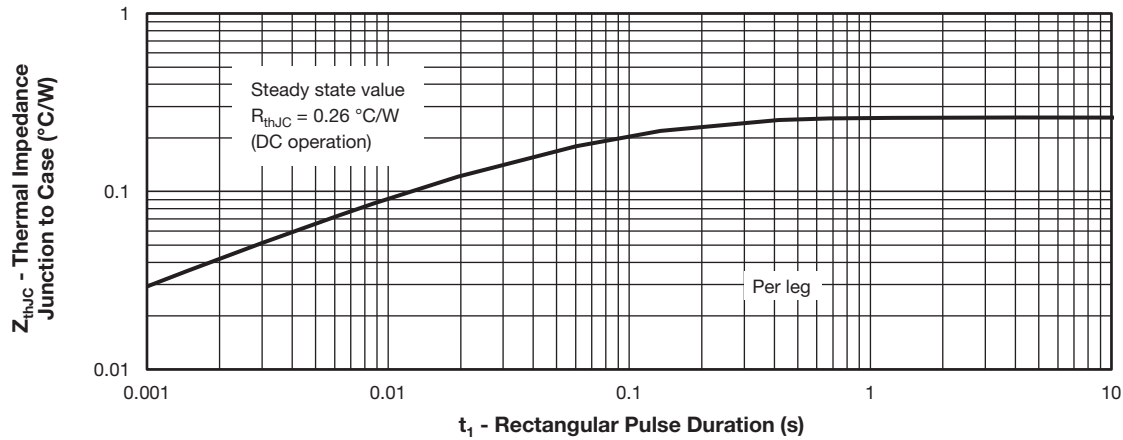

Fig. 8 - Thermal Impedance  $Z_{thJC}$  Characteristics

**ORDERING INFORMATION TABLE**

Device code	<b>VS-</b>	<b>R</b>	<b>A</b>	<b>160</b>	<b>F</b>	<b>A</b>	<b>120</b>
	①	②	③	④	⑤	⑥	⑦

- 1** - Vishay Semiconductors product
- 2** - Standard recovery diode
- 3** - Present silicon generation
- 4** - Current rating (160 = 160 A)
- 5** - Circuit configuration (2 separate diodes, parallel pin-out)
- 6** - Package indicator (SOT-227 standard insulated base)
- 7** - Voltage rating (120 = 1200 V)



CIRCUIT CONFIGURATION		
CIRCUIT	CIRCUIT CONFIGURATION CODE	CIRCUIT DRAWING
Two separate diodes, parallel pin-out	F	<p>The circuit drawing shows two diodes connected in parallel. The anodes are connected to pins 1 and 2, and the cathodes are connected to pins 3 and 4. To the right is a lead assignment diagram of the component's physical package, showing four pins labeled 1, 2, 3, and 4.</p>

LINKS TO RELATED DOCUMENTS	
Dimensions	<a href="http://www.vishay.com/doc?95423">www.vishay.com/doc?95423</a>
Packaging information	<a href="http://www.vishay.com/doc?95425">www.vishay.com/doc?95425</a>



## SOT-227 Generation 2

**DIMENSIONS** in millimeters (inches)

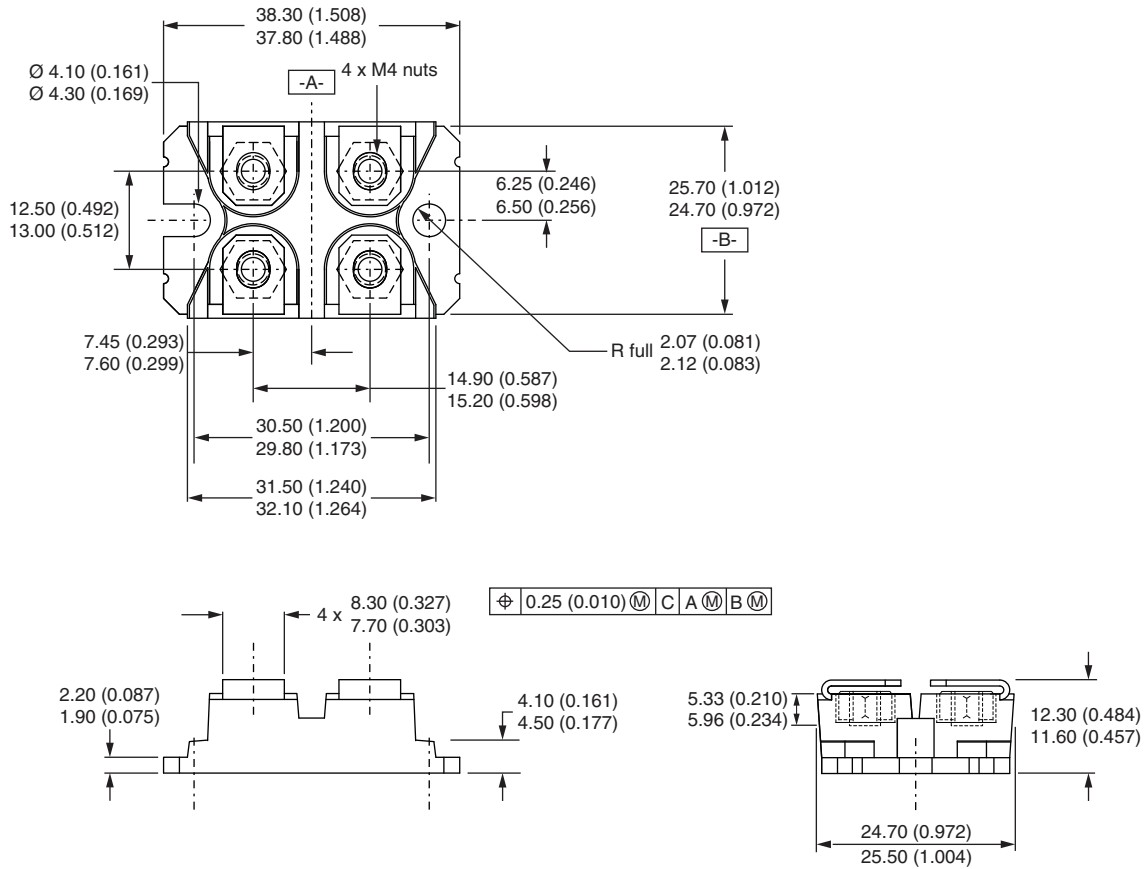

**Note**

- Controlling dimension: millimeter



## **Disclaimer**

ALL PRODUCT, PRODUCT SPECIFICATIONS AND DATA ARE SUBJECT TO CHANGE WITHOUT NOTICE TO IMPROVE RELIABILITY, FUNCTION OR DESIGN OR OTHERWISE.

Vishay Intertechnology, Inc., its affiliates, agents, and employees, and all persons acting on its or their behalf (collectively, "Vishay"), disclaim any and all liability for any errors, inaccuracies or incompleteness contained in any datasheet or in any other disclosure relating to any product.

Vishay makes no warranty, representation or guarantee regarding the suitability of the products for any particular purpose or the continuing production of any product. To the maximum extent permitted by applicable law, Vishay disclaims (i) any and all liability arising out of the application or use of any product, (ii) any and all liability, including without limitation special, consequential or incidental damages, and (iii) any and all implied warranties, including warranties of fitness for particular purpose, non-infringement and merchantability.

Statements regarding the suitability of products for certain types of applications are based on Vishay's knowledge of typical requirements that are often placed on Vishay products in generic applications. Such statements are not binding statements about the suitability of products for a particular application. It is the customer's responsibility to validate that a particular product with the properties described in the product specification is suitable for use in a particular application. Parameters provided in datasheets and / or specifications may vary in different applications and performance may vary over time. All operating parameters, including typical parameters, must be validated for each customer application by the customer's technical experts. Product specifications do not expand or otherwise modify Vishay's terms and conditions of purchase, including but not limited to the warranty expressed therein.

Except as expressly indicated in writing, Vishay products are not designed for use in medical, life-saving, or life-sustaining applications or for any other application in which the failure of the Vishay product could result in personal injury or death. Customers using or selling Vishay products not expressly indicated for use in such applications do so at their own risk. Please contact authorized Vishay personnel to obtain written terms and conditions regarding products designed for such applications.

No license, express or implied, by estoppel or otherwise, to any intellectual property rights is granted by this document or by any conduct of Vishay. Product names and markings noted herein may be trademarks of their respective owners.

Компания «Life Electronics» занимается поставками электронных компонентов импортного и отечественного производства от производителей и со складов крупных дистрибьюторов Европы, Америки и Азии.

С конца 2013 года компания активно расширяет линейку поставок компонентов по направлению коаксиальный кабель, кварцевые генераторы и конденсаторы (керамические, пленочные, электролитические), за счёт заключения дистрибьюторских договоров

Мы предлагаем:

- Конкурентоспособные цены и скидки постоянным клиентам.
- Специальные условия для постоянных клиентов.
- Подбор аналогов.
- Поставку компонентов в любых объемах, удовлетворяющих вашим потребностям.
- Приемлемые сроки поставки, возможна ускоренная поставка.
- Доставку товара в любую точку России и стран СНГ.
- Комплексную поставку.
- Работу по проектам и поставку образцов.
- Формирование склада под заказчика.
- Сертификаты соответствия на поставляемую продукцию (по желанию клиента).
- Тестирование поставляемой продукции.
- Поставку компонентов, требующих военную и космическую приемку.
- Входной контроль качества.
- Наличие сертификата ISO.

В составе нашей компании организован Конструкторский отдел, призванный помогать разработчикам, и инженерам.

Конструкторский отдел помогает осуществить:

- Регистрацию проекта у производителя компонентов.
- Техническую поддержку проекта.
- Защиту от снятия компонента с производства.
- Оценку стоимости проекта по компонентам.
- Изготовление тестовой платы монтаж и пусконаладочные работы.



Тел: +7 (812) 336 43 04 (многоканальный)

Email: [org@lifeelectronics.ru](mailto:org@lifeelectronics.ru)