

## Micropower, wide bandwidth (900 kHz), 16 V CMOS operational amplifiers

Datasheet - production data



- Easy interfacing with high impedance sensors

### Related topics

- See TSX63x series for reduced power consumption (45 mA, 200 kHz)
- See TSX92x series for higher gain bandwidth products (10 MHz)

### Applications

- Industrial and automotive signal conditioning
- Active filtering
- Medical instrumentation
- High impedance sensors

### Description

The TSX56x, TSX56xA series of operational amplifiers benefit from STMicroelectronics® 16 V CMOS technology to offer state-of-the-art accuracy and performance in the smallest industrial packages. The TSX56x, TSX56xA have pinouts compatible with industrial standards and offer an outstanding speed/power consumption ratio, 900 kHz gain bandwidth product while consuming only 250  $\mu$ A at 16 V. Such features make the TSX56x, TSX56xA ideal for sensor interfaces and industrial signal conditioning. The wide temperature range and high ESD tolerance ease use in harsh automotive applications.

Table 1: Device summary

Version	Standard $V_{IO}$	Enhanced $V_{IO}$
Single	TSX561	TSX561A
Dual	TSX562	TSX562A
Quad	TSX564	TSX564A

### Features

- Low power consumption: 235  $\mu$ A typ. at 5 V
- Supply voltage: 3 V to 16 V
- Gain bandwidth product: 900 kHz typ.
- Low offset voltage
  - “A” version: 600  $\mu$ V max.
  - Standard version: 1 mV max.
- Low input bias current: 1 pA typ.
- High tolerance to ESD: 4 kV
- Wide temperature range: -40 to 125 °C
- Automotive qualification
- Tiny packages available: SOT23-5, DFN8 2 mm x 2 mm, MiniSO8, QFN16 3 mm x 3 mm, and TSSOP14

### Benefits

- Power savings in power-conscious applications

## Contents

<b>1</b>	<b>Pinout information.....</b>	<b>3</b>
<b>2</b>	<b>Absolute maximum ratings and operating conditions .....</b>	<b>4</b>
<b>3</b>	<b>Electrical characteristics .....</b>	<b>6</b>
<b>4</b>	<b>Electrical characteristic curves .....</b>	<b>12</b>
<b>5</b>	<b>Application information .....</b>	<b>16</b>
	5.1 Operating voltages .....	16
	5.2 Rail-to-rail input .....	16
	5.3 Input offset voltage drift over temperature .....	16
	5.4 Long term input offset voltage drift .....	17
	5.5 PCB layouts .....	18
	5.6 Macromodel .....	18
<b>6</b>	<b>Package information .....</b>	<b>19</b>
	6.1 SOT23-5 package information .....	20
	6.2 DFN8 2x2 package information .....	21
	6.3 MiniSO8 package information .....	22
	6.4 QFN16 3x3 package information.....	23
	6.5 TSSOP14 package information.....	25
<b>7</b>	<b>Ordering information.....</b>	<b>26</b>
<b>8</b>	<b>Revision history .....</b>	<b>27</b>

# 1 Pinout information

Figure 1: Pin connections for each package (top view)



## 2 Absolute maximum ratings and operating conditions

Table 2: Absolute maximum ratings (AMR)

Symbol	Parameter	Value	Unit	
V <sub>CC</sub>	Supply voltage <sup>(1)</sup>	18	V	
V <sub>id</sub>	Differential input voltage <sup>(2)</sup>	±V <sub>CC</sub>		
V <sub>in</sub>	Input voltage <sup>(3)</sup>	(V <sub>CC-</sub> ) - 0.2 to (V <sub>CC+</sub> ) + 0.2		
I <sub>in</sub>	Input current <sup>(4)</sup>	10	mA	
T <sub>stg</sub>	Storage temperature	-65 to 150	°C	
T <sub>j</sub>	Maximum junction temperature	150		
R <sub>thja</sub>	Thermal resistance junction-to-ambient <sup>(5) (6)</sup>	SOT23-5	250	°C/W
		DFN8 2x2	120	
		MiniSO8	190	
		QFN16 3x3	80	
		TSSOP14	100	
R <sub>thjc</sub>	Thermal resistance junction-to-case	DFN8 2x2	33	
		QFN16 3x3	30	
ESD	HBM: human body model <sup>(7)</sup>	4	kV	
	MM: machine model for TSX561 <sup>(8)</sup>	200	V	
	MM: machine model for TSX562 and TSX564 <sup>(8)</sup>	100		
	CDM: charged device model <sup>(9)</sup>	1.5	kV	
	Latch-up immunity	200	mA	

**Notes:**

- <sup>(1)</sup>All voltage values, except the differential voltage are with respect to the network ground terminal.
- <sup>(2)</sup>The differential voltage is the non-inverting input terminal with respect to the inverting input terminal.
- <sup>(3)</sup>V<sub>CC</sub> - V<sub>in</sub> must not exceed 18 V, V<sub>in</sub> must not exceed 18 V
- <sup>(4)</sup>Input current must be limited by a resistor in series with the inputs.
- <sup>(5)</sup>R<sub>th</sub> are typical values.
- <sup>(6)</sup>Short-circuits can cause excessive heating and destructive dissipation.
- <sup>(7)</sup>Human body model: 100 pF discharged through a 1.5 kΩ resistor between two pins of the device, done for all couples of pin combinations with other pins floating.
- <sup>(8)</sup>Machine model: a 200 pF cap is charged to the specified voltage, then discharged directly between two pins of the device with no external series resistor (internal resistor < 5 Ω), done for all couples of pin combinations with other pins floating.
- <sup>(9)</sup>Charged device model: all pins plus package are charged together to the specified voltage and then discharged directly to ground.

Table 3: Operating conditions

Symbol	Parameter	Value	Unit
$V_{CC}$	Supply voltage	3 to 16	V
$V_{icm}$	Common-mode input voltage range	$(V_{CC-}) - 0.1$ to $(V_{CC+}) + 0.1$	
$T_{oper}$	Operating free-air temperature range	-40 to 125	°C

### 3 Electrical characteristics

Table 4: Electrical characteristics at  $V_{CC+} = 3.3\text{ V}$  with  $V_{CC-} = 0\text{ V}$ ,  $V_{icm} = V_{CC}/2$ ,  $T_{amb} = 25\text{ }^{\circ}\text{C}$ , and  $R_L = 10\text{ k}\Omega$  connected to  $V_{CC}/2$  (unless otherwise specified)

Symbol	Parameter	Conditions	Min.	Typ.	Max.	Unit
<b>DC performance</b>						
$V_{io}$	Offset voltage	TSX56xA, $T = 25\text{ }^{\circ}\text{C}$			600	$\mu\text{V}$
		TSX56xA, $-40\text{ }^{\circ}\text{C} < T < 125\text{ }^{\circ}\text{C}$			1800	
		TSX56x, $T = 25\text{ }^{\circ}\text{C}$			1	mV
		TSX56x, $-40\text{ }^{\circ}\text{C} < T < 125\text{ }^{\circ}\text{C}$			2.2	
$\Delta V_{io}/\Delta T$	Input offset voltage drift	$-40\text{ }^{\circ}\text{C} < T < 125\text{ }^{\circ}\text{C}$ <sup>(1)</sup>		2	12	$\mu\text{V}/^{\circ}\text{C}$
$I_{ib}$	Input bias current, $V_{out} = V_{CC}/2$	$T = 25\text{ }^{\circ}\text{C}$		1	100 <sup>(2)</sup>	pA
		$-40\text{ }^{\circ}\text{C} < T < 125\text{ }^{\circ}\text{C}$		1	200 <sup>(2)</sup>	
$I_{io}$	Input offset current, $V_{out} = V_{CC}/2$	$T = 25\text{ }^{\circ}\text{C}$		1	100 <sup>(2)</sup>	
		$-40\text{ }^{\circ}\text{C} < T < 125\text{ }^{\circ}\text{C}$		1	200 <sup>(2)</sup>	
CMR1	Common mode rejection ratio, $\text{CMR} = 20 \log (\Delta V_{ic}/\Delta V_{io})$ , $V_{ic} = -0.1\text{ V}$ to $V_{CC} - 1.5\text{ V}$ , $V_{out} = V_{CC}/2$ , $R_L > 1\text{ M}\Omega$	$T = 25\text{ }^{\circ}\text{C}$	63	80		dB
		$-40\text{ }^{\circ}\text{C} < T < 125\text{ }^{\circ}\text{C}$	59			
CMR2	Common mode rejection ratio, $\text{CMR} = 20 \log (\Delta V_{ic}/\Delta V_{io})$ , $V_{ic} = -0.1\text{ V}$ to $V_{CC} + 0.1\text{ V}$ , $V_{out} = V_{CC}/2$ , $R_L > 1\text{ M}\Omega$	$T = 25\text{ }^{\circ}\text{C}$	47	66		
		$-40\text{ }^{\circ}\text{C} < T < 125\text{ }^{\circ}\text{C}$	45			
$A_{vd}$	Large signal voltage gain, $V_{out} = 0.5\text{ V}$ to $(V_{CC} - 0.5\text{ V})$ , $R_L > 1\text{ M}\Omega$	$T = 25\text{ }^{\circ}\text{C}$	85			
		$-40\text{ }^{\circ}\text{C} < T < 125\text{ }^{\circ}\text{C}$	83			
$V_{OH}$	High-level output voltage, $V_{OH} = V_{CC} - V_{out}$	$T = 25\text{ }^{\circ}\text{C}$			70	mV
		$-40\text{ }^{\circ}\text{C} < T < 125\text{ }^{\circ}\text{C}$			100	
$V_{OL}$	Low-level output voltage	$T = 25\text{ }^{\circ}\text{C}$			70	
		$-40\text{ }^{\circ}\text{C} < T < 125\text{ }^{\circ}\text{C}$			100	
$I_{out}$	$I_{sink}, V_{out} = V_{CC}$	$T = 25\text{ }^{\circ}\text{C}$	4.3	5.3		mA
		$-40\text{ }^{\circ}\text{C} < T < 125\text{ }^{\circ}\text{C}$	2.5			
	$I_{source}, V_{out} = 0\text{ V}$	$T = 25\text{ }^{\circ}\text{C}$	3.3	4.3		
		$-40\text{ }^{\circ}\text{C} < T < 125\text{ }^{\circ}\text{C}$	2.5			
$I_{CC}$	Supply current, per channel, $V_{out} = V_{CC}/2$ , $R_L > 1\text{ M}\Omega$	$T = 25\text{ }^{\circ}\text{C}$		220	300	$\mu\text{A}$
		$-40\text{ }^{\circ}\text{C} < T < 125\text{ }^{\circ}\text{C}$			350	
<b>AC performance</b>						
GBP	Gain bandwidth product	$R_L = 10\text{ k}\Omega, C_L = 100\text{ pF}$	600	800		kHz
$F_u$	Unity gain frequency			690		
$\phi_m$	Phase margin			55		Degrees
$G_m$	Gain margin			9		dB

Symbol	Parameter	Conditions	Min.	Typ.	Max.	Unit
SR	Slew rate	$R_L = 10\text{ k}\Omega$ , $C_L = 100\text{ pF}$ , $V_{out} = 0.5\text{ V}$ to $V_{CC} - 0.5\text{ V}$		1		V/ $\mu$ s
$e_n$	Equivalent input noise voltage density	$f = 1\text{ kHz}$		55		nV/ $\sqrt{\text{Hz}}$
		$f = 10\text{ kHz}$		29		
$\int e_n$	Low-frequency peak-to-peak input noise	Bandwidth, $f = 0.1$ to $10\text{ Hz}$		16		$\mu$ Vpp
THD+N	Total harmonic distortion + noise	Follower configuration, $f_{in} = 1\text{ kHz}$ , $R_L = 100\text{ k}\Omega$ , $V_{icm} = (V_{CC} - 1.5\text{ V})/2$ , $BW = 22\text{ kHz}$ , $V_{out} = 1\text{ V}_{pp}$		0.004		%

**Notes:**

(1) See [Section 5.3: "Input offset voltage drift over temperature"](#)

(2) Guaranteed by design

Table 5: Electrical characteristics at  $V_{CC+} = 5\text{ V}$  with  $V_{CC-} = 0\text{ V}$ ,  $V_{icm} = V_{CC}/2$ ,  $T_{amb} = 25\text{ }^{\circ}\text{C}$ , and  $R_L = 10\text{ k}\Omega$  connected to  $V_{CC}/2$  (unless otherwise specified)

Symbol	Parameter	Conditions	Min.	Typ.	Max.	Unit
<b>DC performance</b>						
$V_{io}$	Offset voltage	TSX56xA, $T = 25\text{ }^{\circ}\text{C}$			600	$\mu\text{V}$
		TSX56xA, $-40\text{ }^{\circ}\text{C} < T < 125\text{ }^{\circ}\text{C}$			1800	
		TSX56x, $T = 25\text{ }^{\circ}\text{C}$			1	mV
		TSX56x, $-40\text{ }^{\circ}\text{C} < T < 125\text{ }^{\circ}\text{C}$			2.2	
$\Delta V_{io}/\Delta T$	Input offset voltage drift	$-40\text{ }^{\circ}\text{C} < T < 125\text{ }^{\circ}\text{C}$ <sup>(1)</sup>		2	12	$\mu\text{V}/^{\circ}\text{C}$
$\Delta V_{io}$	Long-term input offset voltage drift	$T = 25\text{ }^{\circ}\text{C}$ <sup>(2)</sup>		5		nV/ $\sqrt{\text{month}}$
$I_{ib}$	Input bias current, $V_{out} = V_{CC}/2$	$T = 25\text{ }^{\circ}\text{C}$		1	100 <sup>(3)</sup>	pA
		$-40\text{ }^{\circ}\text{C} < T < 125\text{ }^{\circ}\text{C}$		1	200 <sup>(3)</sup>	
$I_{io}$	Input offset current, $V_{out} = V_{CC}/2$	$T = 25\text{ }^{\circ}\text{C}$		1	100 <sup>(3)</sup>	
		$-40\text{ }^{\circ}\text{C} < T < 125\text{ }^{\circ}\text{C}$		1	200 <sup>(3)</sup>	
CMR1	Common mode rejection ratio, $\text{CMR} = 20\text{ log}(\Delta V_{ic}/\Delta V_{io})$ , $V_{ic} = -0.1\text{ V}$ to $V_{CC} - 1.5\text{ V}$ , $V_{out} = V_{CC}/2$ , $R_L > 1\text{ M}\Omega$	$T = 25\text{ }^{\circ}\text{C}$	66	84		dB
		$-40\text{ }^{\circ}\text{C} < T < 125\text{ }^{\circ}\text{C}$	63			
CMR2	Common mode rejection ratio, $\text{CMR} = 20\text{ log}(\Delta V_{ic}/\Delta V_{io})$ , $V_{ic} = -0.1\text{ V}$ to $V_{CC} + 0.1\text{ V}$ , $V_{out} = V_{CC}/2$ , $R_L > 1\text{ M}\Omega$	$T = 25\text{ }^{\circ}\text{C}$	50	69		
		$-40\text{ }^{\circ}\text{C} < T < 125\text{ }^{\circ}\text{C}$	47			
$A_{vd}$	Large signal voltage gain, $V_{out} = 0.5\text{ V}$ to $(V_{CC} - 0.5\text{ V})$ , $R_L > 1\text{ M}\Omega$	$T = 25\text{ }^{\circ}\text{C}$	85			
		$-40\text{ }^{\circ}\text{C} < T < 125\text{ }^{\circ}\text{C}$	83			
$V_{OH}$	High-level output voltage, $V_{OH} = V_{CC} - V_{out}$	$R_L = 10\text{ k}\Omega$ , $T = 25\text{ }^{\circ}\text{C}$			70	mV
		$R_L = 10\text{ k}\Omega$ , $-40\text{ }^{\circ}\text{C} < T < 125\text{ }^{\circ}\text{C}$			100	
$V_{OL}$	Low-level output voltage	$R_L = 10\text{ k}\Omega$ , $T = 25\text{ }^{\circ}\text{C}$			70	
		$R_L = 10\text{ k}\Omega$ , $-40\text{ }^{\circ}\text{C} < T < 125\text{ }^{\circ}\text{C}$			100	
$I_{out}$	$I_{sink}$	$V_{out} = V_{CC}$ , $T = 25\text{ }^{\circ}\text{C}$	11	14		mA
		$V_{out} = V_{CC}$ , $-40\text{ }^{\circ}\text{C} < T < 125\text{ }^{\circ}\text{C}$	8			
	$I_{source}$	$V_{out} = 0\text{ V}$ , $T = 25\text{ }^{\circ}\text{C}$	9	12		
		$V_{out} = 0\text{ V}$ , $-40\text{ }^{\circ}\text{C} < T < 125\text{ }^{\circ}\text{C}$	7			
$I_{CC}$	Supply current, per channel, $V_{out} = V_{CC}/2$ , $R_L > 1\text{ M}\Omega$	$T = 25\text{ }^{\circ}\text{C}$		235	350	$\mu\text{A}$
		$-40\text{ }^{\circ}\text{C} < T < 125\text{ }^{\circ}\text{C}$			400	
<b>AC performance</b>						
GBP	Gain bandwidth product	$R_L = 10\text{ k}\Omega$ , $C_L = 100\text{ pF}$	700	850		kHz
$F_u$	Unity gain frequency			730		
$\phi_m$	Phase margin			55		Degrees
$G_m$	Gain margin			9		dB



Symbol	Parameter	Conditions	Min.	Typ.	Max.	Unit
SR	Slew rate	$R_L = 10\text{ k}\Omega$ , $C_L = 100\text{ pF}$ , $V_{out} = 0.5\text{ V to }V_{CC} - 0.5\text{ V}$		1.1		V/ $\mu$ s
$e_n$	Equivalent input noise voltage density	$f = 1\text{ kHz}$		55		nV/ $\sqrt{\text{Hz}}$
		$f = 10\text{ kHz}$		29		
$\int e_n$	Low-frequency peak-to-peak input noise	Bandwidth, $f = 0.1\text{ to }10\text{ Hz}$		15		$\mu$ Vpp
THD+N	Total harmonic distortion + noise	Follower configuration, $f_{in} = 1\text{ kHz}$ , $R_L = 100\text{ k}\Omega$ , $V_{icm} = (V_{CC} - 1.5\text{ V})/2$ , $BW = 22\text{ kHz}$ , $V_{out} = 2\text{ V}_{pp}$		0.002		%

**Notes:**

<sup>(1)</sup>See [Section 5.3: "Input offset voltage drift over temperature"](#)

<sup>(2)</sup>Typical value is based on the  $V_{io}$  drift observed after 1000h at 125 °C extrapolated to 25 °C using the Arrhenius law and assuming an activation energy of 0.7 eV. The operational amplifier is aged in follower mode configuration.

<sup>(3)</sup>Guaranteed by design

**Table 6: Electrical characteristics at  $V_{CC+} = 16\text{ V}$  with  $V_{CC-} = 0\text{ V}$ ,  $V_{icm} = V_{CC}/2$ ,  $T_{amb} = 25\text{ }^{\circ}\text{C}$ , and  $R_L = 10\text{ k}\Omega$  connected to  $V_{CC}/2$  (unless otherwise specified)**

Symbol	Parameter	Conditions	Min.	Typ.	Max.	Unit
<b>DC performance</b>						
$V_{io}$	Offset voltage	TSX56xA, $T = 25\text{ }^{\circ}\text{C}$			600	$\mu\text{V}$
		TSX56xA, $-40\text{ }^{\circ}\text{C} < T < 125\text{ }^{\circ}\text{C}$			1800	
		TSX56x, $T = 25\text{ }^{\circ}\text{C}$			1	mV
		TSX56x, $-40\text{ }^{\circ}\text{C} < T < 125\text{ }^{\circ}\text{C}$			2.2	
$\Delta V_{io}/\Delta T$	Input offset voltage drift	$-40\text{ }^{\circ}\text{C} < T < 125\text{ }^{\circ}\text{C}$ <sup>(1)</sup>		2	12	$\mu\text{V}/^{\circ}\text{C}$
$\Delta V_{io}$	Long-term input offset voltage drift	$T = 25\text{ }^{\circ}\text{C}$ <sup>(2)</sup>		1.6		$\text{nV}/\sqrt{\text{month}}$
$I_{ib}$	Input bias current, $V_{out} = V_{CC}/2$	$T = 25\text{ }^{\circ}\text{C}$		1	100 <sup>(3)</sup>	pA
		$-40\text{ }^{\circ}\text{C} < T < 125\text{ }^{\circ}\text{C}$		1	200 <sup>(3)</sup>	
$I_{io}$	Input offset current, $V_{out} = V_{CC}/2$	$T = 25\text{ }^{\circ}\text{C}$		1	100 <sup>(3)</sup>	
		$-40\text{ }^{\circ}\text{C} < T < 125\text{ }^{\circ}\text{C}$		1	200 <sup>(3)</sup>	
CMR1	Common mode rejection ratio, $\text{CMR} = 20\text{ log}(\Delta V_{ic}/\Delta V_{io})$ , $V_{ic} = -0.1\text{ V}$ to $V_{CC} - 1.5\text{ V}$ , $V_{out} = V_{CC}/2$ , $R_L > 1\text{ M}\Omega$	$T = 25\text{ }^{\circ}\text{C}$	76	95		dB
		$-40\text{ }^{\circ}\text{C} < T < 125\text{ }^{\circ}\text{C}$	72			
CMR2	Common mode rejection ratio, $\text{CMR} = 20\text{ log}(\Delta V_{ic}/\Delta V_{io})$ , $V_{ic} = -0.1\text{ V}$ to $V_{CC} + 0.1\text{ V}$ , $V_{out} = V_{CC}/2$ , $R_L > 1\text{ M}\Omega$	$T = 25\text{ }^{\circ}\text{C}$	60	78		
		$-40\text{ }^{\circ}\text{C} < T < 125\text{ }^{\circ}\text{C}$	56			
SVR	Common mode rejection ratio, $20\text{ log}(\Delta V_{CC}/\Delta V_{io})$ , $V_{CC} = 3\text{ V}$ to $16\text{ V}$ , $V_{out} = V_{icm} = V_{CC}/2$	$T = 25\text{ }^{\circ}\text{C}$	76	90		
		$-40\text{ }^{\circ}\text{C} < T < 125\text{ }^{\circ}\text{C}$	72			
$A_{vd}$	Large signal voltage gain, $V_{out} = 0.5\text{ V}$ to $(V_{CC} - 0.5\text{ V})$ , $R_L > 1\text{ M}\Omega$	$T = 25\text{ }^{\circ}\text{C}$	85			
		$-40\text{ }^{\circ}\text{C} < T < 125\text{ }^{\circ}\text{C}$	83			
$V_{OH}$	High-level output voltage, $V_{OH} = V_{CC} - V_{out}$	$R_L = 10\text{ k}\Omega$ , $T = 25\text{ }^{\circ}\text{C}$			70	mV
		$R_L = 10\text{ k}\Omega$ , $-40\text{ }^{\circ}\text{C} < T < 125\text{ }^{\circ}\text{C}$			100	
$V_{OL}$	Low-level output voltage	$R_L = 10\text{ k}\Omega$ , $T = 25\text{ }^{\circ}\text{C}$			70	
		$R_L = 10\text{ k}\Omega$ , $-40\text{ }^{\circ}\text{C} < T < 125\text{ }^{\circ}\text{C}$			100	
$I_{out}$	$I_{sink}$	$V_{out} = V_{CC}$ , $T = 25\text{ }^{\circ}\text{C}$	40	92		mA
		$V_{out} = V_{CC}$ , $-40\text{ }^{\circ}\text{C} < T < 125\text{ }^{\circ}\text{C}$	35			
	$I_{source}$	$V_{out} = 0\text{ V}$ , $T = 25\text{ }^{\circ}\text{C}$	30	90		
		$V_{out} = 0\text{ V}$ , $-40\text{ }^{\circ}\text{C} < T < 125\text{ }^{\circ}\text{C}$	25			
$I_{CC}$	Supply current, per channel, $V_{out} = V_{CC}/2$ , $R_L > 1\text{ M}\Omega$	$T = 25\text{ }^{\circ}\text{C}$		250	360	$\mu\text{A}$
		$-40\text{ }^{\circ}\text{C} < T < 125\text{ }^{\circ}\text{C}$			400	

Symbol	Parameter	Conditions	Min.	Typ.	Max.	Unit
<b>AC performance</b>						
GBP	Gain bandwidth product	$R_L = 10\text{ k}\Omega$ , $C_L = 100\text{ pF}$	750	900		kHz
$F_u$	Unity gain frequency			750		
$\phi_m$	Phase margin			55		Degrees
$G_m$	Gain margin			9		dB
SR	Slew rate	$R_L = 10\text{ k}\Omega$ , $C_L = 100\text{ pF}$ , $V_{out} = 0.5\text{ V}$ to $V_{CC} - 0.5\text{ V}$		1.1		V/ $\mu$ s
$e_n$	Equivalent input noise voltage density	$f = 1\text{ kHz}$		48		nV/ $\sqrt{\text{Hz}}$
		$f = 10\text{ kHz}$		27		
$\int e_n$	Low-frequency peak-to-peak input noise	Bandwidth, $f = 0.1$ to $10\text{ Hz}$		15		$\mu$ Vpp
THD+N	Total harmonic distortion + noise	Follower configuration, $f_{in} = 1\text{ kHz}$ , $R_L = 100\text{ k}\Omega$ , $V_{icm} = (V_{CC} - 1.5\text{ V})/2$ , $BW = 22\text{ kHz}$ , $V_{out} = 5\text{ V}_{pp}$		0.000 5		%

**Notes:**

<sup>(1)</sup>See [Section 5.3: "Input offset voltage drift over temperature"](#)

<sup>(2)</sup>Typical value is based on the  $V_{io}$  drift observed after 1000h at 125 °C extrapolated to 25 °C using the Arrhenius law and assuming an activation energy of 0.7 eV. The operational amplifier is aged in follower mode configuration.

<sup>(3)</sup>Guaranteed by design

## 4 Electrical characteristic curves



Figure 7: Output current vs. output voltage at  $V_{CC} = 3.3\text{ V}$



Figure 8: Output current vs. output voltage at  $V_{CC} = 5\text{ V}$



Figure 9: Output current vs. output voltage at  $V_{CC} = 16\text{ V}$



Figure 10: Bode diagram at  $V_{CC} = 3.3\text{ V}$



Figure 11: Bode diagram at  $V_{CC} = 5\text{ V}$

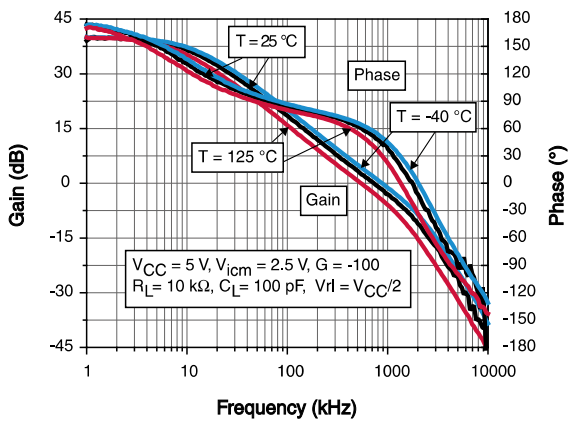

Figure 12: Bode diagram at  $V_{CC} = 16\text{ V}$

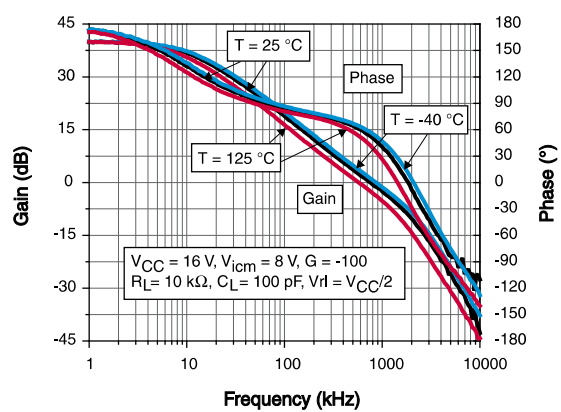

Figure 13: Phase margin vs. capacitive load at  $V_{CC} = 12\text{ V}$

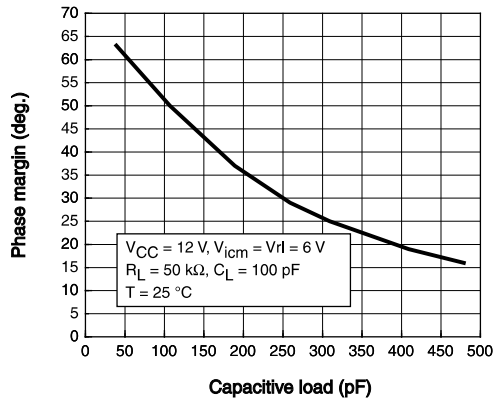

Figure 14: GBP vs. input common-mode voltage at  $V_{CC} = 12\text{ V}$

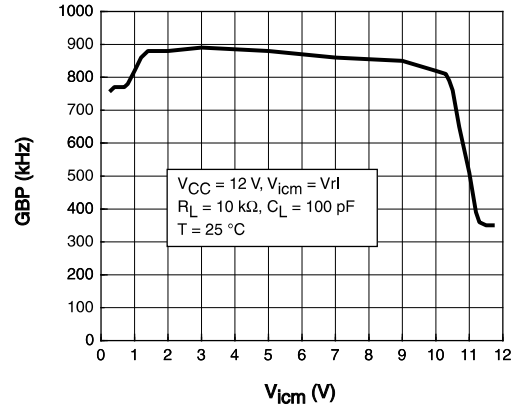

Figure 15:  $A_{vd}$  vs. input common-mode voltage at  $V_{CC} = 12\text{ V}$

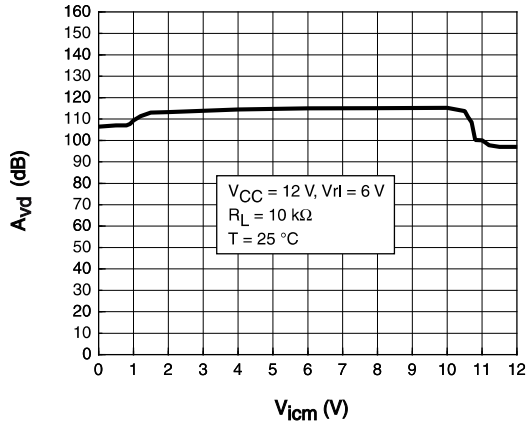

Figure 16: Slew rate vs. supply voltage

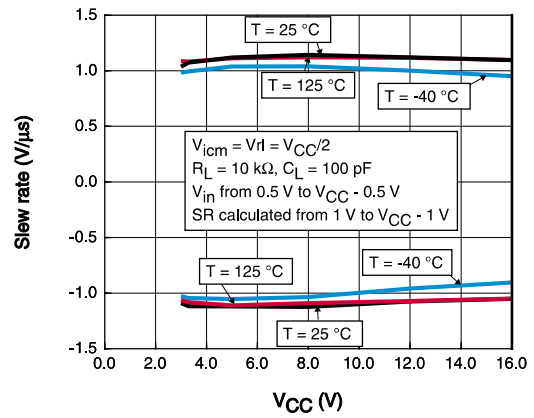

Figure 17: Noise vs. frequency at  $V_{CC} = 3.3\text{ V}$



Figure 18: Noise vs. frequency at  $V_{CC} = 5\text{ V}$





## 5 Application information

### 5.1 Operating voltages

The amplifiers of the TSX56x and TSX56xA series can operate from 3 V to 16 V. Their parameters are fully specified at 3.3 V, 5 V, and 16 V power supplies. However, the parameters are very stable in the full  $V_{CC}$  range. Additionally, the main specifications are guaranteed in extended temperature ranges from -40 to 125 °C.

### 5.2 Rail-to-rail input

The TSX56x and TSX56xA devices are built with two complementary PMOS and NMOS input differential pairs. The devices have a rail-to-rail input, and the input common mode range is extended from  $(V_{CC-}) - 0.1$  V to  $(V_{CC+}) + 0.1$  V.

However, the performance of these devices is clearly optimized for the PMOS differential pairs (which means from  $(V_{CC-}) - 0.1$  V to  $(V_{CC+}) - 1.5$  V).

Beyond  $(V_{CC+}) - 1.5$  V, the operational amplifiers are still functional but with degraded performance, as can be observed in the electrical characteristics section of this datasheet (mainly  $V_{io}$  and GBP). These performances are suitable for a number of applications that need to be rail-to-rail.

The devices are designed to prevent phase reversal.

### 5.3 Input offset voltage drift over temperature

The maximum input voltage drift over the temperature variation is defined as the offset variation related to the offset value measured at 25 °C. The operational amplifier is one of the main circuits of the signal conditioning chain, and the amplifier input offset is a major contributor to the chain accuracy. The signal chain accuracy at 25 °C can be compensated during production at application level. The maximum input voltage drift over temperature enables the system designer to anticipate the effects of temperature variations.

The maximum input voltage drift over temperature is computed using [Equation 1](#).

#### Equation 1

$$\frac{\Delta V_{io}}{\Delta T} = \max \left| \frac{V_{io}(T) - V_{io}(25\text{ °C})}{T - 25\text{ °C}} \right|$$

Where T = -40 °C and 125 °C.

The datasheet maximum value is guaranteed by measurements on a representative sample size ensuring a  $C_{pk}$  (process capability index) greater than 2.



## 5.4 Long term input offset voltage drift

To evaluate product reliability, two types of stress acceleration are used:

- Voltage acceleration, by changing the applied voltage
- Temperature acceleration, by changing the die temperature (below the maximum junction temperature allowed by the technology) with the ambient temperature.

The voltage acceleration has been defined based on JEDEC results, and is defined using [Equation 2](#).

### Equation 2

$$A_{FV} = e^{\beta \cdot (V_S - V_U)}$$

Where:

$A_{FV}$  is the voltage acceleration factor

$\beta$  is the voltage acceleration constant in  $1/V$ , constant technology parameter ( $\beta = 1$ )

$V_S$  is the stress voltage used for the accelerated test

$V_U$  is the voltage used for the application

The temperature acceleration is driven by the Arrhenius model, and is defined in [Equation 3](#).

### Equation 3

$$A_{FT} = e^{\frac{E_a}{k} \cdot \left( \frac{1}{T_U} - \frac{1}{T_S} \right)}$$

Where:

$A_{FT}$  is the temperature acceleration factor

$E_a$  is the activation energy of the technology based on the failure rate

$k$  is the Boltzmann constant ( $8.6173 \times 10^{-5} \text{ eV} \cdot \text{K}^{-1}$ )

$T_U$  is the temperature of the die when  $V_U$  is used (K)

$T_S$  is the temperature of the die under temperature stress (K)

The final acceleration factor,  $A_F$ , is the multiplication of the voltage acceleration factor and the temperature acceleration factor ([Equation 4](#)).

### Equation 4

$$A_F = A_{FT} \times A_{FV}$$

$A_F$  is calculated using the temperature and voltage defined in the mission profile of the product. The  $A_F$  value can then be used in [Equation 5](#) to calculate the number of months of use equivalent to 1000 hours of reliable stress duration.

### Equation 5

$$\text{Months} = A_F \times 1000 \text{ h} \times 12 \text{ months} / (24 \text{ h} \times 365.25 \text{ days})$$

To evaluate the op amp reliability, a follower stress condition is used where  $V_{CC}$  is defined as a function of the maximum operating voltage and the absolute maximum rating (as recommended by JEDEC rules).

The  $V_{io}$  drift (in  $\mu\text{V}$ ) of the product after 1000 h of stress is tracked with parameters at different measurement conditions (see [Equation 6](#)).

**Equation 6**

$$V_{CC} = \max V_{op} \text{ with } V_{icm} = V_{CC} / 2$$

The long term drift parameter ( $\Delta V_{io}$ ), estimating the reliability performance of the product, is obtained using the ratio of the  $V_{io}$  (input offset voltage value) drift over the square root of the calculated number of months ([Equation 7](#)).

**Equation 7**

$$\Delta V_{io} = \frac{V_{io} \text{ drift}}{\sqrt{(\text{months})}}$$

Where  $V_{io}$  drift is the measured drift value in the specified test conditions after 1000 h stress duration.

## 5.5 PCB layouts

For correct operation, it is advised to add 10 nF decoupling capacitors as close as possible to the power supply pins.

## 5.6 Macromodel

Accurate macromodels of the TSX56x, TSX56xA devices are available on the STMicroelectronics' website at: [www.st.com](http://www.st.com). These models are a trade-off between accuracy and complexity (that is, time simulation) of the TSX56x and TSX56xA operational amplifiers. They emulate the nominal performance of a typical device within the specified operating conditions mentioned in the datasheet. They also help to validate a design approach and to select the right operational amplifier, *but they do not replace on-board measurements*.

## 6 Package information

In order to meet environmental requirements, ST offers these devices in different grades of ECOPACK® packages, depending on their level of environmental compliance. ECOPACK® specifications, grade definitions and product status are available at: [www.st.com](http://www.st.com). ECOPACK® is an ST trademark.

## 6.1 SOT23-5 package information

Figure 23: SOT23-5 package outline

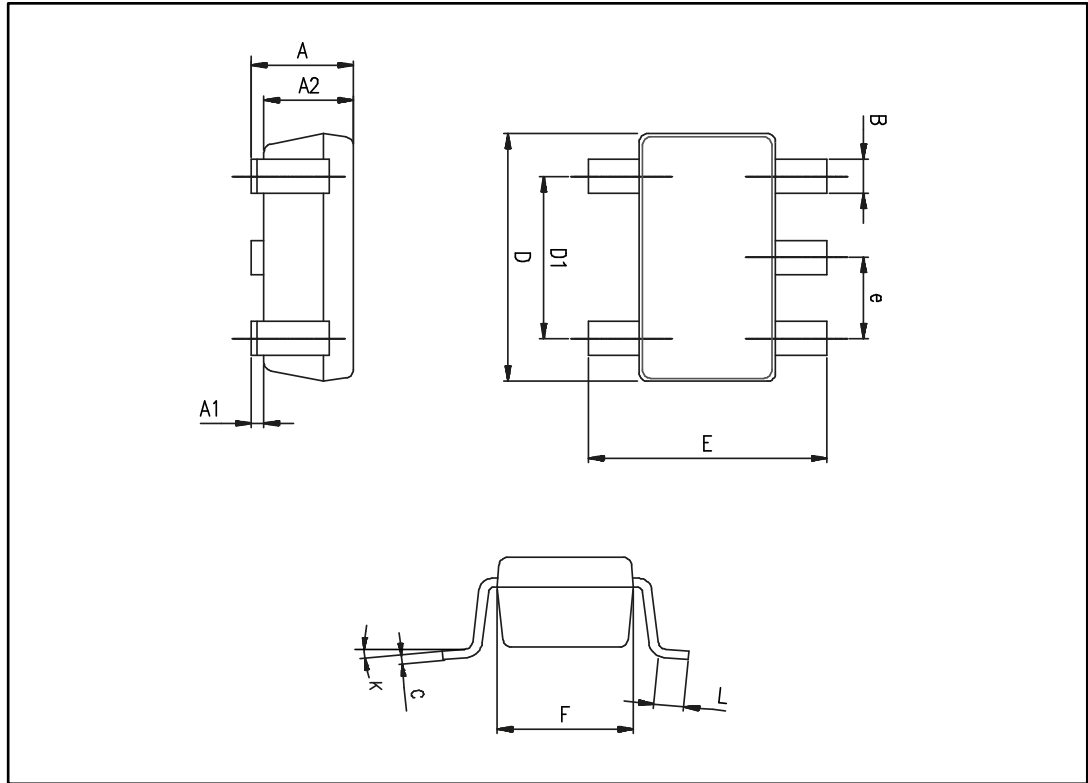

Table 7: SOT23-5 mechanical data

Ref.	Dimensions					
	Millimeters			Inches		
	Min.	Typ.	Max.	Min.	Typ.	Max.
A	0.90	1.20	1.45	0.035	0.047	0.057
A1			0.15			0.006
A2	0.90	1.05	1.30	0.035	0.041	0.051
B	0.35	0.40	0.50	0.014	0.016	0.020
C	0.09	0.15	0.20	0.004	0.006	0.008
D	2.80	2.90	3.00	0.110	0.114	0.118
D1		1.90			0.075	
e		0.95			0.037	
E	2.60	2.80	3.00	0.102	0.110	0.118
F	1.50	1.60	1.75	0.059	0.063	0.069
L	0.10	0.35	0.60	0.004	0.014	0.024
K	0 degrees		10 degrees	0 degrees		10 degrees

## 6.2 DFN8 2x2 package information

Figure 24: DFN8 2x2 package outline



Table 8: DFN8 2x2 mechanical data

Ref.	Dimensions					
	Millimeters			Inches		
	Min.	Typ.	Max.	Min.	Typ.	Max.
A	0.70	0.75	0.80	0.028	0.030	0.031
A1	0.00	0.02	0.05	0.000	0.001	0.002
b	0.15	0.20	0.25	0.006	0.008	0.010
D		2.00			0.079	
E		2.00			0.079	
e		0.50			0.020	
L	0.045	0.55	0.65	0.018	0.022	0.026

### 6.3 MiniSO8 package information

Figure 25: MiniSO8 package outline



Table 9: MiniSO8 mechanical data

Ref.	Dimensions					
	Millimeters			Inches		
	Min.	Typ.	Max.	Min.	Typ.	Max.
A			1.1			0.043
A1	0		0.15	0		0.006
A2	0.75	0.85	0.95	0.030	0.033	0.037
b	0.22		0.40	0.009		0.016
c	0.08		0.23	0.003		0.009
D	2.80	3.00	3.20	0.11	0.118	0.126
E	4.65	4.90	5.15	0.183	0.193	0.203
E1	2.80	3.00	3.10	0.11	0.118	0.122
e		0.65			0.026	
L	0.40	0.60	0.80	0.016	0.024	0.031
L1		0.95			0.037	
L2		0.25			0.010	
k	0°		8°	0°		8°
ccc			0.10			0.004

### 6.4 QFN16 3x3 package information

Figure 26: QFN16 3x3 package outline



Table 10: QFN16 3x3 mechanical data

Ref.	Dimensions					
	Millimeters			Inches		
	Min.	Typ.	Max.	Min.	Typ.	Max.
A	0.50		0.65	0.020		0.026
A1	0		0.05	0		0.002
b	0.18	0.25	0.30	0.007	0.010	0.012
D		3.00			0.118	
E		3.00			0.118	
e		0.50			0.020	
L	0.30		0.50	0.012		0.020
aaa			0.15			0.006
bbb			0.10			0.004
ccc			0.10			0.004
ddd			0.05			0.002
eee			0.08			0.003



### 6.5 TSSOP14 package information

Figure 27: TSSOP14 package outline



Table 11: TSSOP14 mechanical data

Ref.	Dimensions					
	Millimeters			Inches		
	Min.	Typ.	Max.	Min.	Typ.	Max.
A			1.20			0.047
A1	0.05		0.15	0.002	0.004	0.006
A2	0.80	1.00	1.05	0.031	0.039	0.041
b	0.19		0.30	0.007		0.012
c	0.09		0.20	0.004		0.0089
D	4.90	5.00	5.10	0.193	0.197	0.201
E	6.20	6.40	6.60	0.244	0.252	0.260
E1	4.30	4.40	4.50	0.169	0.173	0.176
e		0.65			0.0256	
L	0.45	0.60	0.75	0.018	0.024	0.030
L1		1.00			0.039	
k	0°		8°	0°		8°
aaa			0.10			0.004

## 7 Ordering information

Table 12: Order codes

Order code	Temperature range	Channel number	Package	Packaging	Marking
TSX561ILT	-40 to 125 °C	1	SOT23-5	Tape and reel	K23
TSX562IQ2T		2	DFN8 2x2		
TSX562IST			MiniSO8		
TSX564IQ4T		4	QFN16 3x3		
TSX564IPT			TSSOP14		TSX5641
TSX561IYLT <sup>(1)</sup>	-40 to 125 °C automotive grade	1	SOT23-5		K116
TSX562IYST <sup>(1)</sup>		2	MiniSO8		TSX5641Y
TSX564IYPT <sup>(1)</sup>		4	TSSOP14		
TSX561AILT	-40 to 125 °C	1	SOT23-5		K117
TSX562AIST		2	MiniSO8		TSX564AI
TSX564AIPT		4	TSSOP14		
TSX561AIYLT <sup>(1)</sup>	-40 to 125 °C automotive grade	1	SOT23-5		K118
TSX562AIYST <sup>(1)</sup>		2	MiniSO8		
TSX564AIYPT <sup>(1)</sup>		4	TSSOP14		

**Notes:**

<sup>(1)</sup>Qualified and characterized according to AEC Q100 and Q003 or equivalent, advanced screening according to AEC Q001 & Q 002 or equivalent

## 8 Revision history

Table 13: Document revision history

Date	Revision	Changes
06-Aug-2012	1	Initial release.
18-Sep-2012	2	Added TSX562, TSX564, TSX562A, and TSX564A devices. Updated Features, Description, Figure 1, Table 1 (added DFN8, MiniSO8, QFN16, and TSSOP14 package). Updated Table 1 (updated ESD MM values). Updated Table 4 and Table 5 (added footnotes), Section 5 (added Figure 24 to Figure 28 and Table 8 to Table 12), Table 13 (added dual and quad devices). Minor corrections throughout document.
23-May-2013	3	Replaced the silhouette, pinout, package diagram, and mechanical data of the DFN8 2x2 and QFN16 3x3 packages. Added Benefits and Related products. Table 1: updated $R_{thja}$ values and added $R_{thjc}$ values for DFN8 2x2 and QFN16 3x3. Updated Section 4.3, Section 4.4, and Section 4.6 Replaced Figure 23: SOT23-5 package mechanical drawing and Table 7: SOT23-5 package mechanical data.
09-Aug-2013	4	Added SO8 package for dual version TSX562 and TSX562A. Table 2: updated for SO8 package Table 13: added order codes TSX562IDT, TSX562IYDT, TSX562AIDT, TSX562AIYDT; updated automotive grade status.
07-Feb-2017	5	Removed SO8 package <a href="#">Table 8: "DFN8 2x2 mechanical data"</a> : removed "N" <a href="#">Table 11: "TSSOP14 mechanical data"</a> : added "L" and "L1" in inches; updated "aaa" in inches. <a href="#">Table 12: "Order codes"</a> : removed TSX562IDT, TSX562IYDT, TSX562AIDT, TSX562AIYDT. Updated terminology

**IMPORTANT NOTICE – PLEASE READ CAREFULLY**

STMicroelectronics NV and its subsidiaries ("ST") reserve the right to make changes, corrections, enhancements, modifications, and improvements to ST products and/or to this document at any time without notice. Purchasers should obtain the latest relevant information on ST products before placing orders. ST products are sold pursuant to ST's terms and conditions of sale in place at the time of order acknowledgement.

Purchasers are solely responsible for the choice, selection, and use of ST products and ST assumes no liability for application assistance or the design of Purchasers' products.

No license, express or implied, to any intellectual property right is granted by ST herein.

Resale of ST products with provisions different from the information set forth herein shall void any warranty granted by ST for such product.

ST and the ST logo are trademarks of ST. All other product or service names are the property of their respective owners.

Information in this document supersedes and replaces information previously supplied in any prior versions of this document.

© 2017 STMicroelectronics – All rights reserved

Компания «Life Electronics» занимается поставками электронных компонентов импортного и отечественного производства от производителей и со складов крупных дистрибьюторов Европы, Америки и Азии.

С конца 2013 года компания активно расширяет линейку поставок компонентов по направлению коаксиальный кабель, кварцевые генераторы и конденсаторы (керамические, пленочные, электролитические), за счёт заключения дистрибьюторских договоров

Мы предлагаем:

- Конкурентоспособные цены и скидки постоянным клиентам.
- Специальные условия для постоянных клиентов.
- Подбор аналогов.
- Поставку компонентов в любых объемах, удовлетворяющих вашим потребностям.
- Приемлемые сроки поставки, возможна ускоренная поставка.
- Доставку товара в любую точку России и стран СНГ.
- Комплексную поставку.
- Работу по проектам и поставку образцов.
- Формирование склада под заказчика.
- Сертификаты соответствия на поставляемую продукцию (по желанию клиента).
- Тестирование поставляемой продукции.
- Поставку компонентов, требующих военную и космическую приемку.
- Входной контроль качества.
- Наличие сертификата ISO.

В составе нашей компании организован Конструкторский отдел, призванный помогать разработчикам, и инженерам.

Конструкторский отдел помогает осуществить:

- Регистрацию проекта у производителя компонентов.
- Техническую поддержку проекта.
- Защиту от снятия компонента с производства.
- Оценку стоимости проекта по компонентам.
- Изготовление тестовой платы монтаж и пусконаладочные работы.



Тел: +7 (812) 336 43 04 (многоканальный)  
Email: [org@lifeelectronics.ru](mailto:org@lifeelectronics.ru)