

FEATURES

- High integration:**
 - 32-channel DAC in 12 mm × 12 mm CSPBGA
- Adjustable voltage output range**
- Guaranteed monotonic**
- Readback capability**
- DSP/microcontroller compatible serial interface**
- Output impedance:**
 - 0.5 Ω (AD5532-1, AD5532-2)
 - 500 Ω (AD5532-3)
 - 1 kΩ (AD5532-5)
- Output voltage span:**
 - 10 V (AD5532-1, AD5532-3, AD5532-5)
 - 20 V (AD5532-2)
- Infinite sample-and-hold capability to ±0.018% accuracy**
- Temperature range –40°C to +85°C**

APPLICATIONS

- Automatic test equipment
- Optical networks
- Level setting
- Instrumentation
- Industrial control systems
- Data acquisition
- Low cost I/O

GENERAL DESCRIPTION

The AD5532¹ is a 32-channel, 14-bit voltage-output DAC with an additional infinite sample-and-hold mode. The selected DAC register is written to via the 3-wire serial interface; V_{OUT} for this DAC is then updated to reflect the new contents of the DAC register. DAC selection is accomplished via Address Bits A0–A4. The output voltage range is determined by the offset voltage at the OFFS_IN pin and the gain of the output amplifier. It is restricted to a range from $V_{SS} + 2\text{ V}$ to $V_{DD} - 2\text{ V}$ because of the headroom of the output amplifier.

The device is operated with $AV_{CC} = 5\text{ V} \pm 5\%$; $DV_{CC} = 2.7\text{ V}$ to 5.25 V ; $V_{SS} = -4.75\text{ V}$ to -16.5 V ; and $V_{DD} = 8\text{ V}$ to 16.5 V . The AD5532 requires a stable 3 V reference on REF_IN as well as an offset voltage on OFFS_IN.

PRODUCT HIGHLIGHTS

1. 32-channel, 14-bit DAC in one package, guaranteed monotonic.
2. Available in a 74-lead CSPBGA package with a body size of 12 mm × 12 mm.
3. Droopless/infinite sample-and-hold mode.

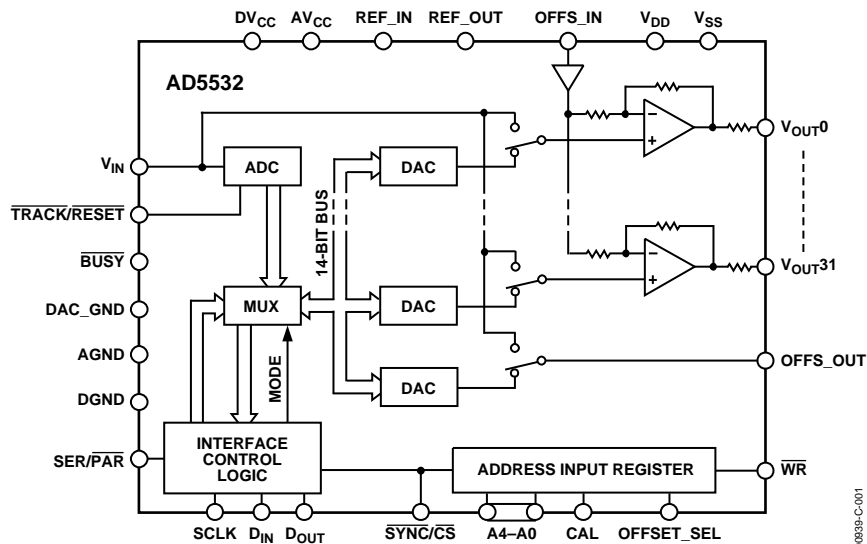

Figure 1. Functional Block Diagram

Rev. D

Information furnished by Analog Devices is believed to be accurate and reliable. However, no responsibility is assumed by Analog Devices for its use, nor for any infringements of patents or other rights of third parties that may result from its use. Specifications subject to change without notice. No license is granted by implication or otherwise under any patent or patent rights of Analog Devices. Trademarks and registered trademarks are the property of their respective owners.

TABLE OF CONTENTS

| | | | |
|--|----|---|----|
| Specifications..... | 3 | Output Buffer Stage—Gain and Offset..... | 14 |
| ISHA Mode..... | 5 | Offset Voltage Channel..... | 14 |
| Timing Characteristics..... | 6 | Reset Function..... | 14 |
| Parallel Interface..... | 6 | ISHA Mode..... | 14 |
| Parallel Interface Timing Diagrams..... | 6 | Analog Input (ISHA Mode)..... | 14 |
| Serial Interface..... | 7 | $\overline{\text{TRACK}}$ Function (ISHA Mode)..... | 15 |
| Absolute Maximum Ratings..... | 8 | Modes of Operation..... | 15 |
| ESD Caution..... | 8 | Serial Interface..... | 16 |
| Pin Configuration and Function Descriptions..... | 9 | Parallel Interface (ISHA Mode Only)..... | 17 |
| Terminology..... | 11 | Microprocessor Interfacing..... | 17 |
| Dac Mode..... | 11 | Application Circuits..... | 18 |
| ISHA Mode..... | 11 | Power Supply Decoupling..... | 19 |
| Typical Performance Characteristics..... | 12 | Outline Dimensions..... | 20 |
| Functional Description..... | 14 | Ordering Guide..... | 20 |

REVISION HISTORY

6/10—Data Sheet Changed from Rev. C to Rev. D

| | |
|--------------------------------|----|
| Changes to Table 5..... | 8 |
| Changes to Ordering Guide..... | 20 |

6/04—Data Sheet Changed from Rev. B to Rev. C

| | |
|------------------------------------|-----------|
| Updated Format..... | Universal |
| Changed LFBGA to CSPBGA..... | Universal |
| Changes to Outline Dimensions..... | 24 |
| Changes to Ordering Guide..... | 24 |

6/02—Data Sheet Changed from Rev. A to Rev. B

| | |
|---|--------|
| Term SHA changed to ISHA..... | Global |
| Changes to Absolute Maximum Ratings..... | 6 |
| Changes to Ordering Guide..... | 6 |
| Changes to Functional Description..... | 11 |
| Changes to Table 8..... | 11 |
| Changes to ISHA Mode..... | 11 |
| Added Figure 27 and accompanying text..... | 15 |
| Changes to Power Supply Decoupling Section..... | 15 |

SPECIFICATIONS

$V_{DD} = 8\text{ V}$ to 16.5 V , $V_{SS} = -4.75\text{ V}$ to -16.5 V ; $AV_{CC} = 4.75\text{ V}$ to 5.25 V ; $DV_{CC} = 2.7\text{ V}$ to 5.25 V ; $AGND = DGND = DAC_GND = 0\text{ V}$; $REF_IN = 3\text{ V}$; output range from $V_{SS} + 2\text{ V}$ to $V_{DD} - 2\text{ V}$. All outputs unloaded. All specifications T_{MIN} to T_{MAX} , unless otherwise noted.

Table 1.

| Parameter ² | A Version ¹ | | Unit | Conditions/Comments |
|---|-------------------------|-------------------------|-----------------------------|---------------------------------|
| | AD5532-1/-3/-5 | AD5532-2 Only | | |
| DAC DC PERFORMANCE | | | | |
| Resolution | 14 | 14 | Bits | |
| Integral Nonlinearity (INL) | ± 0.39 | ± 0.39 | % of FSR max | $\pm 0.15\%$ typ |
| Differential Nonlinearity (DNL) | ± 1 | ± 1 | LSB max | ± 0.5 LSB typ, monotonic |
| Offset | 90/170/250 | 180/350/500 | mV min/typ/max | See Figure 8 |
| Gain | 3.52 | 7 | typ | |
| Full Scale Error | ± 2 | ± 2 | % of FSR max | |
| VOLTAGE REFERENCE | | | | |
| REF_IN | | | | |
| Nominal Input Voltage | 3.0 | 3.0 | V typ | |
| Input Voltage Range ³ | 2.85/3.15 | 2.85/3.15 | V min/max | |
| Input Current | 1 | 1 | μA max | $< 1\text{ nA}$ typ |
| REF_OUT | | | | |
| Output Voltage | 3 | 3 | V typ | |
| Output Impedance ³ | 280 | 280 | k Ω typ | |
| Reference Temperature Coefficient ³ | 60 | 60 | ppm/ $^{\circ}\text{C}$ typ | |
| ANALOG OUTPUTS (V_{OUT} 0–31) | | | | |
| Output Temperature Coefficient ^{3, 4} | 10 | 10 | ppm/ $^{\circ}\text{C}$ typ | |
| DC Output Impedance ³ | | | | |
| AD5532-1 | 0.5 | 0.5 | Ω typ | |
| AD5532-3 | 500 | | Ω typ | |
| AD5532-5 | 1 | | k Ω typ | |
| Output Range | $V_{SS} + 2/V_{DD} - 2$ | $V_{SS} + 2/V_{DD} - 2$ | V min/max | |
| Resistive Load ^{3, 5} | 5 | 5 | k Ω min | |
| Capacitive Load ^{3, 5} | | | | |
| AD5532-1 | 500 | 500 | pF max | |
| AD5532-3 | 15 | | nF max | |
| AD5532-5 | 40 | | nF max | |
| Short-Circuit Current ³ | 7 | 7 | mA typ | |
| DC Power-Supply Rejection Ratio ³ | | | | |
| | -70 | -70 | dB typ | $V_{DD} = +15\text{ V} \pm 5\%$ |
| | -70 | -70 | dB typ | $V_{SS} = -15\text{ V} \pm 5\%$ |
| DC Crosstalk ³ | 250 | 1800 | μV max | |
| ANALOG OUTPUT (OFFS_OUT) | | | | |
| Output Temperature Coefficient ^{3, 4} | 10 | 10 | ppm/ $^{\circ}\text{C}$ typ | |
| DC Output Impedance ³ | 1.3 | 1.3 | k Ω typ | |
| Output Range | 50 to REF_IN-12 | 50 to REF_IN-12 | mV typ | |
| Output Current | 10 | 10 | μA max | Source current |
| Capacitive Load | 100 | 100 | pF max | |
| DIGITAL INPUTS³ | | | | |
| Input Current | ± 10 | ± 10 | μA max | $\pm 5\text{ }\mu\text{A}$ typ |
| Input Low Voltage | | | | |
| | 0.8 | 0.8 | V max | $DV_{CC} = 5\text{ V} \pm 5\%$ |
| | 0.4 | 0.4 | V max | $DV_{CC} = 3\text{ V} \pm 10\%$ |
| Input High Voltage | | | | |
| | 2.4 | 2.4 | V min | $DV_{CC} = 5\text{ V} \pm 5\%$ |
| | 2.0 | 2.0 | V min | $DV_{CC} = 3\text{ V} \pm 10\%$ |
| Input Hysteresis (SCLK and $\overline{\text{CS}}$ Only) | 200 | 200 | mV typ | |

AD5532

| Parameter ² | A Version ¹ | | Unit | Conditions/Comments |
|--|------------------------|---------------|--------------|---|
| | AD5532-1/-3/-5 | AD5532-2 Only | | |
| Input Capacitance | 10 | 10 | pF max | |
| DIGITAL OUTPUTS (BUSY, D _{OUT}) ³ | | | | |
| Output Low Voltage, DV _{CC} = 5 V | 0.4 | 0.4 | V max | Sinking 200 μA. |
| Output High Voltage, DV _{CC} = 5 V | 4.0 | 4.0 | V min | Sourcing 200 μA. |
| Output Low Voltage, DV _{CC} = 3 V | 0.4 | 0.4 | V max | Sinking 200 μA. |
| Output High Voltage, DV _{CC} = 3 V | 2.4 | 2.4 | V min | Sourcing 200 μA. |
| High Impedance Leakage Current | ±1 | ±1 | μA max | D _{OUT} only. |
| High Impedance Output Capacitance | 15 | 15 | pF typ | D _{OUT} only. |
| POWER REQUIREMENTS | | | | |
| Power-Supply Voltages | | | | |
| V _{DD} | 8/16.5 | 8/16.5 | V min/max | |
| V _{SS} | -4.75/-16.5 | -4.75/-16.5 | V min/max | |
| AV _{CC} | 4.75/5.25 | 4.75/5.25 | V min/max | |
| DV _{CC} | 2.7/5.25 | 2.7/5.25 | V min/max | |
| Power-Supply Currents ⁶ | | | | |
| I _{DD} | 15 | 15 | mA max | 10 mA typ. All channels full scale. |
| I _{SS} | 15 | 15 | mA max | 10 mA typ. All channels full scale. |
| AICC | 33 | 33 | mA max | 26 mA typ. |
| DICC | 1.5 | 1.5 | mA max | 1 mA typ. |
| Power Dissipation ⁶ | 280 | 280 | mW typ | V _{DD} = 10 V, V _{SS} = -5 V. |
| AC CHARACTERISTICS ³ | | | | |
| Output Voltage Settling Time | 22 | 30 | μs max | 500 pF, 5 kΩ load. Full-scale change. |
| OFFS_IN Settling Time | 10 | 25 | μs max | 500 pF, 5 kΩ load; 0 V to 3 V step. |
| Digital-to-Analog Glitch Impulse | 1 | 1 | nV-s typ | 1 LSB change around. Major carry. |
| Digital Crosstalk | 5 | 5 | nV-s typ | |
| Analog Crosstalk | 1 | 1 | nV-s typ | |
| Digital Feedthrough | 0.2 | 0.2 | nV-s typ | |
| Output Noise Spectral Density @ 1 kHz | 400 | 400 | nV/(√Hz) typ | |

¹ A version: Industrial temperature range -40°C to +85°C; typical at +25°C.

² See Terminology section.

³ Guaranteed by design and characterization, not production tested.

⁴ AD780 as reference for the AD5532.

⁵ Ensure that you do not exceed T_J (max). See Absolute Maximum Ratings section.

⁶ Output unloaded.

ISHA MODE

Table 2.

| Parameter ² | A Version ¹ | | Unit | Conditions/Comments |
|---|------------------------|---------------|-------------|--|
| | AD5532-1/-3/-5 | AD5532-2 Only | | |
| ANALOG CHANNEL | | | | |
| V _{IN} to V _{OUT} Nonlinearity ³ | ±0.018 | ±0.018 | % max | ±0.006% typ after offset and gain adjustment. |
| Offset Error | ±50 | ±75 | mV max | ±10 mV typ. See Figure 9. |
| Gain | 3.46/3.52/3.6 | 6.96/7/7.02 | min/typ/max | See Figure 9 |
| ANALOG INPUT (V _{IN}) | | | | |
| Input Voltage Range | 0 to 3 | 0 to 3 | V | Nominal input range. |
| Input Lower Dead Band | 70 | 70 | mV max | 50 mV typ. Referred to V _{IN} . See Figure 9. |
| Input Upper Dead Band | 40 | 40 | mV max | 12 mV typ. Referred to V _{IN} . See Figure 9. |
| Input Current | 1 | 1 | µA max | 100 nA typ. |
| Input Capacitance ⁴ | 20 | 20 | pF typ | V _{IN} acquired on 1 channel. |
| ANALOG INPUT (OFFS_IN) | | | | |
| Input Current | 1 | 1 | µA max | 100 nA typ. |
| Input Voltage Range | 0/4 | 0/4 | Vmin/max | Output range restricted from V _{SS} + 2 V to V _{DD} - 2 V. |
| AC CHARACTERISTICS | | | | |
| Output Settling Time ⁴ | 3 | 3 | µs max | Output unloaded. |
| Acquisition Time | 16 | 16 | µs max | |
| AC Crosstalk ⁴ | 5 | 5 | nV-s typ | |

¹ A version: Industrial temperature range -40°C to +85°C; typical at +25°C.

² See Terminology section.

³ Input range 100 mV to 2.96 V.

⁴ Guaranteed by design and characterization, not production tested.

TIMING CHARACTERISTICS

PARALLEL INTERFACE

Table 3.

| Parameter ^{1, 2} | Limit at T _{MIN} , T _{MAX} (A Version) | Unit | Conditions/Comments |
|---------------------------|--|--------|---|
| t ₁ | 0 | ns min | $\overline{\text{CS}}$ to $\overline{\text{WR}}$ setup time |
| t ₂ | 0 | ns min | $\overline{\text{CS}}$ to $\overline{\text{WR}}$ hold time |
| t ₃ | 50 | ns min | $\overline{\text{CS}}$ pulse width low |
| t ₄ | 50 | ns min | $\overline{\text{WR}}$ pulse width low |
| t ₅ | 20 | ns min | A4–A0, CAL, OFFS_SEL to $\overline{\text{WR}}$ setup time |
| t ₆ | 7 | ns min | A4–A0, CAL, OFFS_SEL to $\overline{\text{WR}}$ hold time |

¹ See Figure 2 and Figure 3, the parallel interface timing diagrams.

² Guaranteed by design and characterization, not production tested.

PARALLEL INTERFACE TIMING DIAGRAMS

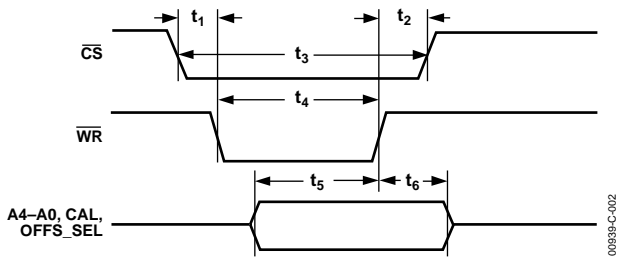

Figure 2. Parallel Write (ISHA Mode Only)

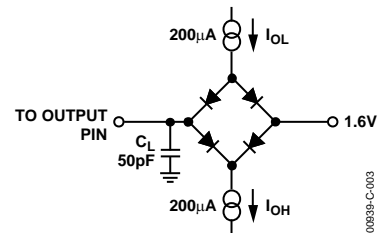

Figure 3. Load Circuit for D_{OUT} Timing Specifications

SERIAL INTERFACE

Table 4.

| Parameter ^{1, 2} | Limit at T _{MIN} , T _{MAX} (A Version) | Unit | Conditions/Comments |
|---------------------------------|--|---------|---|
| f _{CLKIN} ³ | 14 | MHz max | SCLK frequency |
| t ₁ | 28 | ns min | SCLK high pulse width |
| t ₂ | 28 | ns min | SCLK low pulse width |
| t ₃ | 15 | ns min | $\overline{\text{SYNC}}$ falling edge to SCLK falling edge setup time |
| t ₄ | 50 | ns min | $\overline{\text{SYNC}}$ low time |
| t ₅ | 10 | ns min | D _{IN} setup time |
| t ₆ | 5 | ns min | D _{IN} hold time |
| t ₇ | 5 | ns min | $\overline{\text{SYNC}}$ falling edge to SCLK rising edge setup time for read back |
| t ₈ ⁴ | 20 | ns max | SCLK rising edge to D _{OUT} valid |
| t ₉ ⁴ | 60 | ns max | SCLK falling edge to D _{OUT} high impedance |
| t ₁₀ | 400 | ns min | 10th SCLK falling edge to $\overline{\text{SYNC}}$ falling edge for read back |
| t ₁₁ | 400 | ns min | 24th SCLK falling edge to $\overline{\text{SYNC}}$ falling edge for DAC mode write |
| t ₁₂ ⁵ | 7 | ns min | SCLK falling edge to $\overline{\text{SYNC}}$ falling edge setup time for read back |

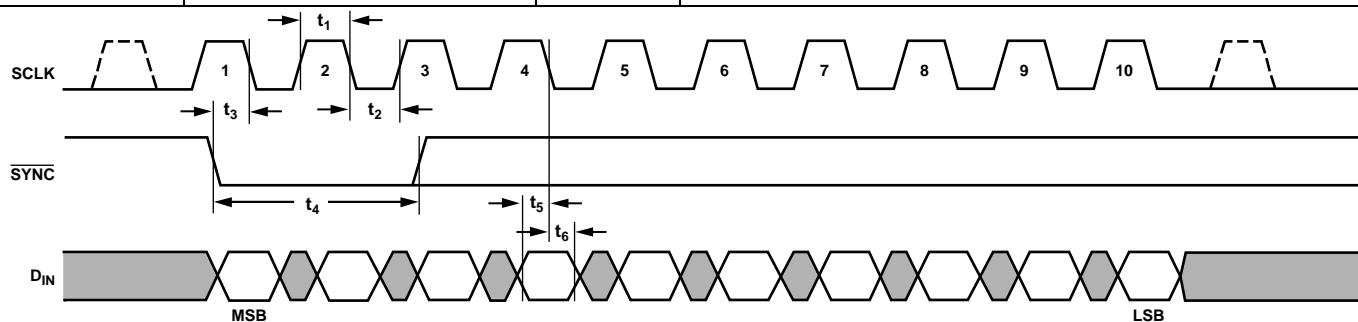

Figure 4. 10-Bit Write (ISHA Mode and Both Readback Modes)

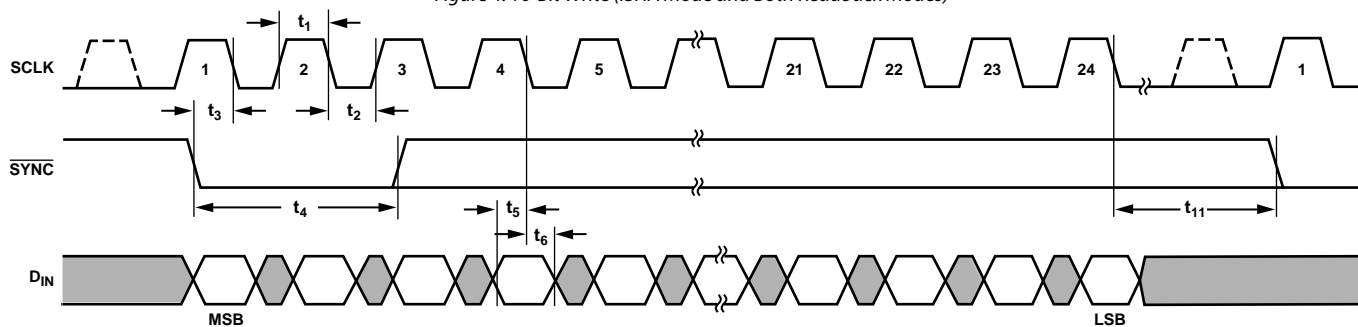

Figure 5. 24-Bit Write (DAC Mode)

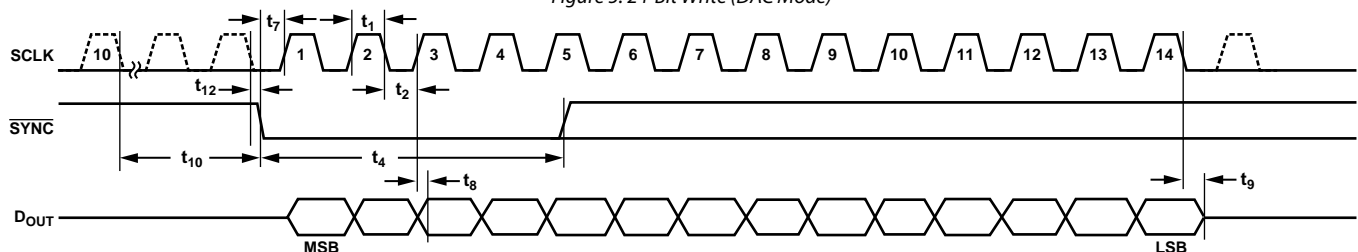

Figure 6. 14-Bit Read (Both Readback Modes)

¹ See Figure 4, Figure 5, and Figure 6.

² Guaranteed by design and characterization, not production tested.

³ In ISHA mode the maximum SCLK frequency is 20 MHz and the minimum pulse width is 20 ns.

⁴ These numbers are measured with the load circuit of Figure 3.

⁵ SYNC should be taken low while SCLK is low for read back.

ABSOLUTE MAXIMUM RATINGS

$T_A = 25^\circ\text{C}$ unless otherwise noted.

Table 5.

| Parameter ¹ | Rating |
|--|---|
| V_{DD} to AGND | -0.3 V to +17 V |
| V_{SS} to AGND | +0.3 V to -17 V |
| AV_{CC} to AGND, DAC_GND | -0.3 V to +7 V |
| DV_{CC} to DGND | -0.3 V to +7 V |
| Digital Inputs to DGND | -0.3 V to $DV_{CC} + 0.3$ V |
| Digital Outputs to DGND | -0.3 V to $DV_{CC} + 0.3$ V |
| REF_IN to AGND, DAC_GND | -0.3 V to $AV_{CC} + 0.3$ V |
| V_{IN} to AGND, DAC_GND | -0.3 V to $AV_{CC} + 0.3$ V |
| $V_{OUT\ 0-31}$ to AGND | $V_{SS} - 0.3$ V to $V_{DD} + 0.3$ V |
| OFFS_IN to AGND | $V_{SS} - 0.3$ V to $V_{DD} + 0.3$ V |
| OFFS_OUT to AGND | AGND - 0.3 V to $AV_{CC} + 0.3$ V |
| AGND to DGND | -0.3 V to +0.3 V |
| Operating Temperature Range | |
| Industrial | -40°C to +85°C |
| Storage Temperature Range | -65°C to +150°C |
| Junction Temperature (T_J max) | 150°C |
| 74-Lead CSPBGA Package, θ_{JA} Thermal Impedance | 41°C/W |
| Reflow Soldering | |
| Peak Temperature | |
| AD5532ABC-x | 220°C |
| AD5532ABCZ-x | 260°C |
| Time at Peak Temperature | 10 sec to 40 sec |
| Max Power Dissipation | $(150^\circ\text{C} - T_A)/\theta_{JA}$ mW ² |
| Max Continuous Load Current at $T_J = 70^\circ\text{C}$, per Channel Group | 15 mA ³ |

Stresses above those listed under Absolute Maximum Ratings may cause permanent damage to the device. This is a stress rating only; functional operation of the device at these or any other conditions above those indicated in the operational section of this specification is not implied. Exposure to absolute maximum rating conditions for extended periods may affect device reliability.

For higher junction temperatures derate as follows:

| T_J (°C) | Max Continuous Load Current per Group (mA) |
|------------|--|
| 70 | 15.5 |
| 90 | 9.025 |
| 100 | 6.925 |
| 110 | 5.175 |
| 125 | 3.425 |
| 135 | 2.55 |
| 150 | 1.5 |

ESD CAUTION



ESD (electrostatic discharge) sensitive device. Charged devices and circuit boards can discharge without detection. Although this product features patented or proprietary protection circuitry, damage may occur on devices subjected to high energy ESD. Therefore, proper ESD precautions should be taken to avoid performance degradation or loss of functionality.

¹ Transient currents of up to 100 mA do not cause SCR latch-up.

² This limit includes load power.

³ This maximum allowed continuous load current is spread over 8 channels and channels are grouped as follows:

Group 1: Channels 3, 4, 5, 6, 7, 8, 9, 10

Group 2: Channels 14, 16, 18, 20, 21, 24, 25, 26

Group 3: Channels 15, 17, 19, 22, 23, 27, 28, 29

Group 4: Channels 0, 1, 2, 11, 12, 13, 30, 31

PIN CONFIGURATION AND FUNCTION DESCRIPTIONS

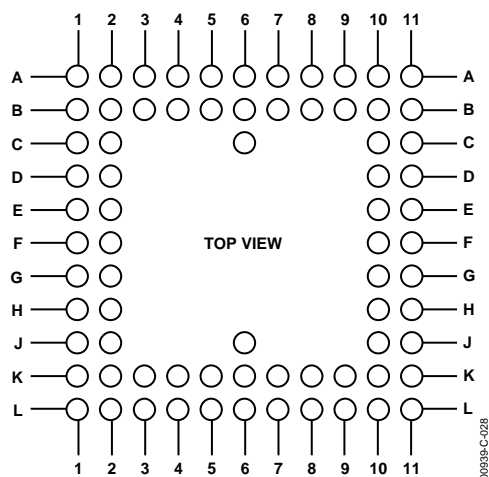

Figure 7. 74-Lead CSPBGA Ball Configuration

Table 6. 74-Lead CSPBGA Ball Configuration

| CSPBGA Number | Ball Name | CSPBGA Number | Ball Name | CSPBGA Number | Ball Name |
|---------------|---------------------------------|---------------|--------------------|---------------|-------------------|
| A1 | Not connected | C10 | AV _{CC} 1 | J10 | VO9 |
| A2 | A4 | C11 | REF_OUT | J11 | VO11 |
| A3 | A2 | D1 | VO20 | K1 | VO17 |
| A4 | A0 | D2 | DAC_GND2 | K2 | VO15 |
| A5 | $\overline{\text{CS/SYNC}}$ | D10 | AV _{CC} 2 | K3 | VO27 |
| A6 | DV _{CC} | D11 | OFFS_OUT | K4 | V _{SS} 3 |
| A7 | SCLK | E1 | VO26 | K5 | V _{SS} 1 |
| A8 | OFFSET_SEL | E2 | VO14 | K6 | V _{SS} 4 |
| A9 | $\overline{\text{BUSY}}$ | E10 | AGND1 | K7 | V _{DD} 2 |
| A10 | $\overline{\text{TRACK/RESET}}$ | E11 | OFFS_IN | K8 | VO2 |
| A11 | Not connected | F1 | VO25 | K9 | VO10 |
| B1 | VO16 | F2 | VO21 | K10 | VO13 |
| B2 | Not connected | F10 | AGND2 | K11 | VO12 |
| B3 | A3 | F11 | VO6 | L1 | Not connected |
| B4 | A1 | G1 | VO24 | L2 | VO28 |
| B5 | $\overline{\text{WR}}$ | G2 | VO8 | L3 | VO29 |
| B6 | DGND | G10 | VO5 | L4 | VO30 |
| B7 | D _{IN} | G11 | VO3 | L5 | V _{DD} 3 |
| B8 | CAL | H1 | VO23 | L6 | V _{DD} 1 |
| B9 | $\overline{\text{SER/PAR}}$ | H2 | VIN | L7 | V _{DD} 4 |
| B10 | DOUT | H10 | VO4 | L8 | VO31 |
| B11 | REF_IN | H11 | VO7 | L9 | VO0 |
| C1 | VO18 | J1 | VO22 | L10 | VO1 |
| C2 | DAC_GND1 | J2 | VO19 | L11 | Not connected |
| C6 | Not connected | J6 | V _{SS} 2 | | |

Table 7. Pin Function Descriptions

| Pin | Function |
|---------------------------------|---|
| AGND (1–2) | Analog GND pins. |
| AV _{CC} (1–2) | Analog Supply pins. Voltage range from 4.75 V to 5.25 V. |
| V _{DD} (1–4) | V _{DD} Supply pins. Voltage range from 8 V to 16.5 V. |
| V _{SS} (1–4) | V _{SS} Supply pins. Voltage range from –4.75 V to –16.5 V. |
| DGND | Digital GND pins. |
| DV _{CC} | Digital Supply pins. Voltage range from 2.7 V to 5.25 V. |
| DAC_GND (1–2) | Reference GND supply for all DACs. |
| REF_IN | Reference voltage for Channels 0–31. |
| REF_OUT | Reference Output Voltage. |
| V _{OUT} (0–31) | Analog Output Voltages from the 32 channels. |
| V _{IN} | Analog Input Voltage. Connect this to AGND if operating in DAC mode only. |
| A4–A1, A0 | Parallel Interface: 5 address pins for 32 channels. A4 = MSB of channel address. A0 = LSB. Internal pull-up devices on these logic inputs. Therefore, they can be left floating and default to a logic high condition. |
| CAL | Parallel Interface: Control input that allows all 32 channels to acquire V _{IN} simultaneously. Internal pull-down devices on these logic inputs. Therefore, they can be left floating and default to a logic low condition |
| $\overline{\text{CS/SYNC}}$ | This is the active low Chip Select pin for the parallel interface and the Frame Synchronization pin for the serial interface. |
| $\overline{\text{WR}}$ | Parallel interface: Write pin; active low. This is used in conjunction with the $\overline{\text{CS}}$ pin to address the device using the parallel interface. Internal pull-down devices on these logic inputs. Therefore, they can be left floating and default to a logic low condition. |
| OFFSET_SEL | Parallel interface: Offset Select pin; active high. This is used to select the offset channel. Internal pull-down devices on these logic inputs. Therefore, they can be left floating and default to a logic low condition |
| SCLK | Serial Clock Input for Serial Interface. This operates at clock speeds up to 14 MHz (20 MHz in ISHA mode). |
| D _{IN} | Data Input for Serial Interface. Data must be valid on the falling edge of SCLK. Internal pull-up devices on these logic inputs. Therefore, they can be left floating and default to a logic high condition. |
| D _{OUT} | Output from the DAC registers for read back. Data is clocked out on the rising edge of SCLK and is valid on the falling edge of SCLK. |
| SER/ $\overline{\text{PAR}}$ | This pin allows the user to select whether the serial or parallel interface is used. If the pin is tied low, the parallel interface is used. If it is tied high, the serial interface is used. Internal pull-down devices on these logic inputs. Therefore, they can be left floating and default to a logic low condition. |
| OFFS_IN | Offset Input. The user can supply a voltage here to offset the output span. OFFS_OUT can also be tied to this pin if the user wants to drive this pin with the offset channel. |
| OFFS_OUT | Offset Output. This is the acquired/programmed offset voltage which can be tied to OFFS_IN to offset the span. |
| $\overline{\text{BUSY}}$ | This output tells the user when the input voltage is being acquired. It goes low during acquisition and returns high when the acquisition operation is complete. |
| $\overline{\text{TRACK/RESET}}$ | If this input is held high, V _{IN} is acquired once the channel is addressed. While it is held low, the input to the gain/offset stage is switched directly to V _{IN} . The addressed channel begins to acquire V _{IN} on the rising edge of $\overline{\text{TRACK}}$. See TRACK Input section for further information. This input can also be used as a means of resetting the complete device to its power-on-reset conditions. This is achieved by applying a low-going pulse of between 90 ns and 200 ns to this pin. See section on $\overline{\text{RESET}}$ Function for further details. Internal pull-up devices on these logic inputs. Therefore, they can be left floating and default to a logic high condition. |

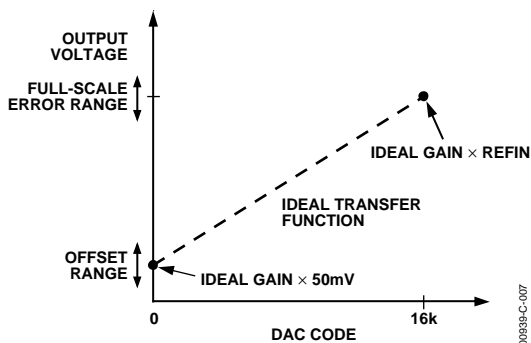

Figure 8. DAC Transfer Function (OFFS_IN=0)

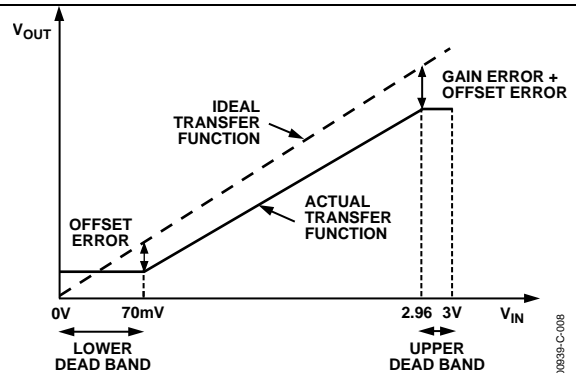

Figure 9. ISHA Transfer Function

TERMINOLOGY

DAC MODE

Integral Nonlinearity (INL)

This is a measure of the maximum deviation from a straight line passing through the endpoints of the DAC transfer function. It is expressed as a percentage of full-scale span.

Differential Nonlinearity (DNL)

This is the difference between the measured change and the ideal 1 LSB change between any two adjacent codes. A specified DNL of ± 1 LSB maximum ensures monotonicity.

Offset

Offset is a measure of the output with all zeros loaded to the DAC and OFFS_IN = 0. Because the DAC is lifted off the ground by approximately 50 mV, this output is typically

$$V_{OUT} = \text{Gain} \times 50 \text{ mV}$$

Full-Scale Error

This is a measure of the output error with all 1s loaded to the DAC. It is expressed as a percentage of full-scale range. See Figure 8. It is calculated as

$$\text{Full-Scale Error} = V_{OUT(\text{Full-Scale})} - (\text{Ideal Gain} \times \text{REFIN})$$

where

$$\text{Ideal Gain} = 3.52 \text{ for AD5532-1/-3/-5}$$

$$\text{Ideal Gain} = 7 \text{ for AD5532-2}$$

Output Settling Time

This is the time taken from when the last data bit is clocked into the DAC until the output has settled to within $\pm 0.39\%$.

OFFS_IN Settling Time

The time taken from a 0 V to 3 V step change in input voltage on OFFS_IN until the output has settled to within $\pm 0.39\%$.

Digital-to-Analog Glitch Impulse

This is the area of the glitch injected into the analog output when the code in the DAC register changes state. It is specified as the area of the glitch in nV-secs when the digital code is changed by 1 LSB at the major carry transition (011 . . . 11 to 100 . . . 00 or 100 . . . 00 to 011 . . . 11).

Digital Crosstalk

This is the glitch impulse transferred to the output of one DAC at midscale while a full-scale code change (all 1s to all 0s and vice versa) is written to another DAC. It is expressed in nV-secs.

Analog Crosstalk

This is the area of the glitch transferred to the output (V_{OUT}) of one DAC due to a full-scale change in the output (V_{OUT}) of another DAC. The area of the glitch is expressed in nV-secs.

Digital Feedthrough

This is a measure of the impulse injected into the analog outputs from the digital control inputs when the part is not being written to, i.e., $\overline{\text{CS}}/\overline{\text{SYNC}}$ is high. It is specified in nV-secs and is measured with a worst-case change on the digital input pins, for example, from all 0s to all 1s and vice versa.

Output Noise Spectral Density

This is a measure of internally generated random noise. Random noise is characterized as a spectral density (voltage per root Hertz). It is measured by loading all DACs to midscale and measuring noise at the output. It is measured in $\text{nV}/(\sqrt{\text{Hz}})$.

Output Temperature Coefficient

This is a measure of the change in analog output with changes in temperature. It is expressed in $\text{ppm}/^\circ\text{C}$.

DC Power-Supply Rejection Ratio (PSRR)

DC power-supply rejection ratio is a measure of the change in analog output for a change in supply voltage (V_{DD} and V_{SS}). It is expressed in dBs. V_{DD} and V_{SS} are varied $\pm 5\%$.

DC Crosstalk

This is the DC change in the output level of one DAC at midscale in response to a full-scale code change (all 0s to all 1s and vice versa) and an output change of all other DACs. It is expressed in μV .

ISHA MODE

V_{IN} to V_{OUT} Nonlinearity

The measure of the maximum deviation from a straight line passing through the endpoints of the V_{IN} versus V_{OUT} transfer function. It is expressed as a percentage of the full-scale span.

Offset Error

This is a measure of the output error when $V_{IN} = 70$ mV. Ideally, with $V_{IN} = 70$ mV:

$$V_{OUT} = (\text{Gain} \times 70) - ((\text{Gain} - 1) \times V_{\text{OFFS_IN}}) \text{ mV}$$

Offset error is a measure of the difference between V_{OUT} (actual) and V_{OUT} (ideal). It is expressed in mV and can be positive or negative. See Figure 9.

Gain Error

This is a measure of the span error of the analog channel. It is the deviation in slope of the transfer function expressed in mV. See Figure 9. It is calculated as

$$\text{Gain Error} = \frac{\text{Actual Full-Scale Output} - \text{Ideal Full-Scale Output} - \text{Offset Error}}{\text{Ideal Full-Scale Output}}$$

where:

$$\text{Ideal Full-Scale Output} = \text{Gain} \times 2.96 - ((\text{Gain} - 1) \times V_{\text{OFFS_IN}})$$

AC Crosstalk

This is the area of the glitch that occurs on the output of one channel while another channel is acquiring. It is expressed in nV-secs.

Output Settling Time

This is the time taken from when $\overline{\text{BUSY}}$ goes high to when the output has settled to $\pm 0.018\%$.

Acquisition Time

This is the time taken for the V_{IN} input to be acquired. It is the length of time that $\overline{\text{BUSY}}$ stays low.

TYPICAL PERFORMANCE CHARACTERISTICS

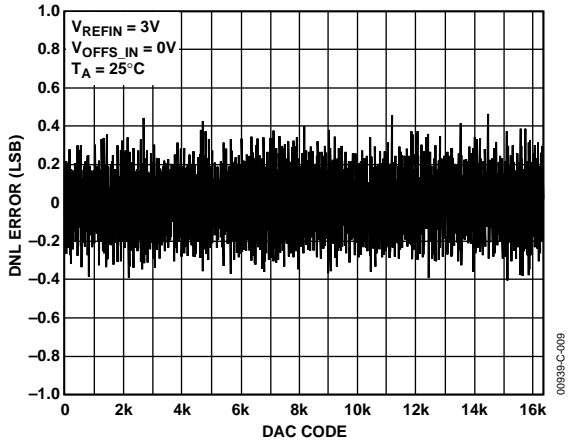

Figure 10. Typical DNL Plot

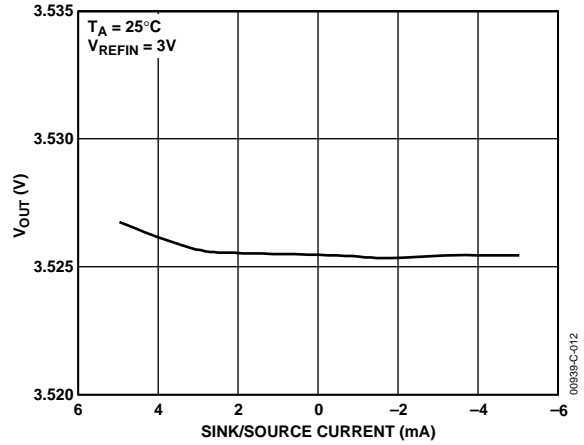

Figure 13. V_{out} Source and Sink Capability

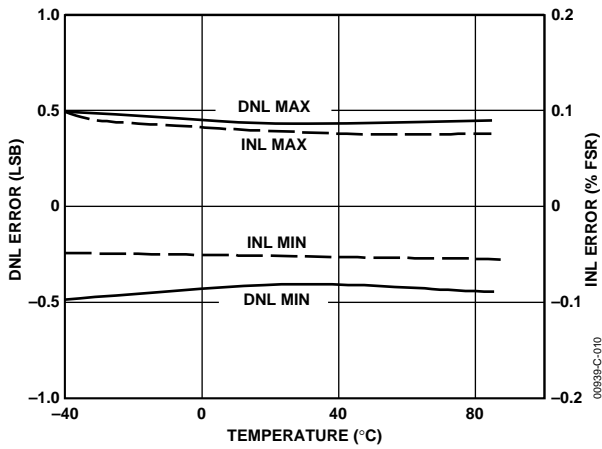

Figure 11. INL Error and DNL Error vs. Temperature

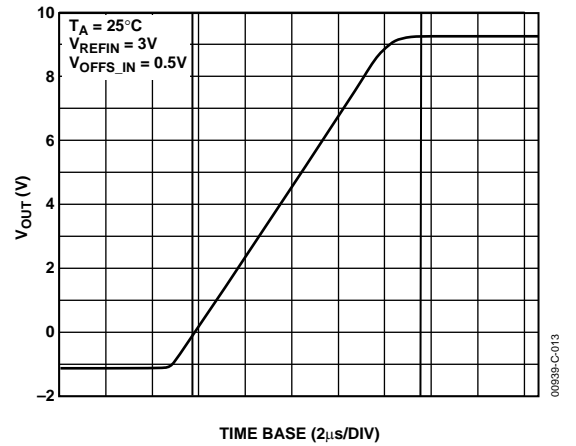

Figure 14. Full-Scale Settling Time

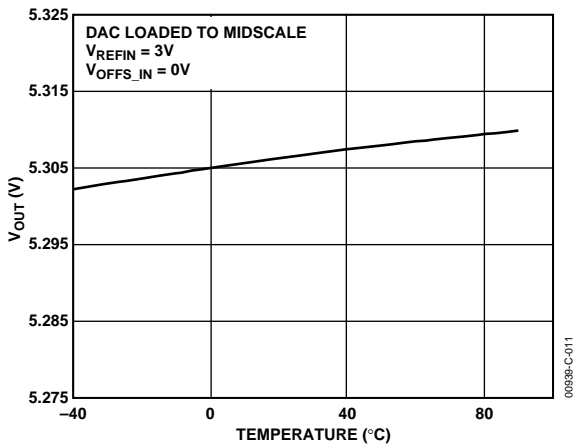

Figure 12. V_{out} vs. Temperature

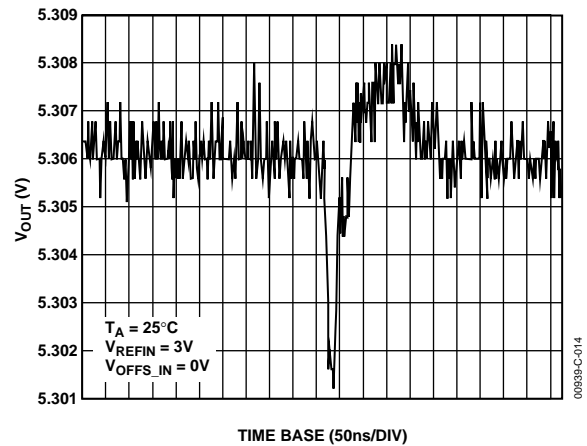

Figure 15. Major Code Transition Glitch Impulse

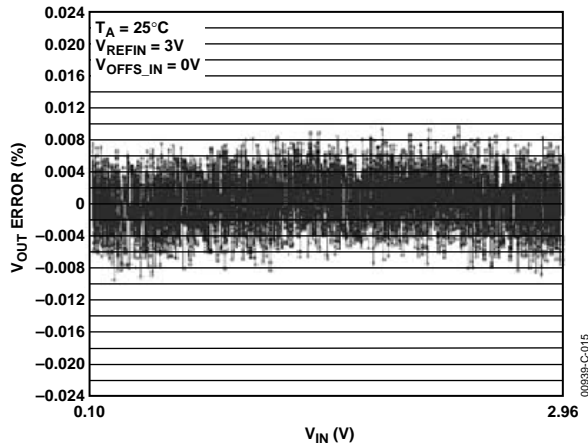

Figure 16. V_{IN} to V_{OUT} Accuracy after Offset and Gain Adjustment (ISHA Mode)

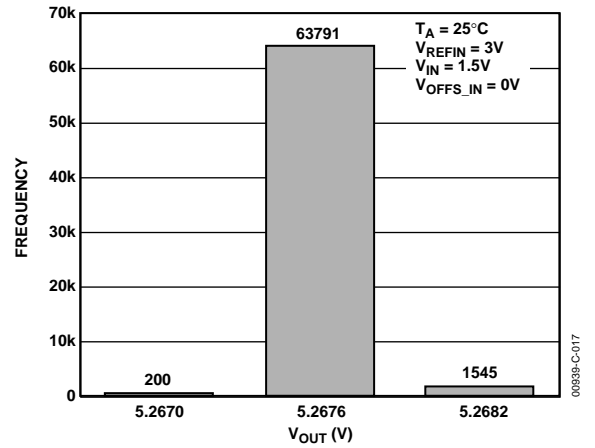

Figure 18. ISHA-Mode Repeatability (64 k Acquisitions)

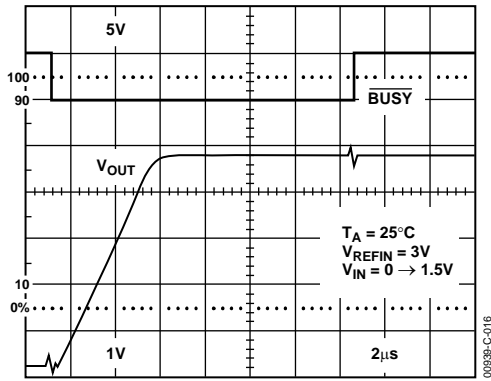

Figure 17. Acquisition Time and Output Settling Time (ISHA Mode)

FUNCTIONAL DESCRIPTION

The AD5532 consists of 32 DACs and an ADC (for ISHA mode) in a single package. In DAC mode, a 14-bit digital word is loaded into one of the 32 DAC Registers via the serial interface. This is then converted (with gain and offset) into an analog output voltage (V_{OUT0} – V_{OUT31}).

To update a DAC's output voltage, the required DAC is addressed via the serial port. When the DAC address and code have been loaded, the selected DAC converts the code.

At power-on, all the DACs, including the offset channel, are loaded with zeros. Each of the 33 DACs is offset internally by 50 mV (typ) from GND, so the outputs $V_{OUT 0}$ to $V_{OUT 31}$ are 50 mV (typ) at power-on if the OFFS_IN pin is driven directly by the on-board offset channel (OFFS_OUT), i.e. if OFFS_IN is 50 mV, $V_{OUT} = (\text{Gain} \times V_{DAC}) - (\text{Gain} - 1) \times V_{OFFS_IN} = 50 \text{ mV}$.

OUTPUT BUFFER STAGE—GAIN AND OFFSET

The function of the output buffer stage is to translate the 50 mV–3 V output of the DAC to a wider range. This is done by gaining up the DAC output by 3.52/7 and offsetting the voltage by the voltage on OFFS_IN pin.

AD5532-1/AD5532-3/AD5532-5:

$$V_{OUT} = 3.52 \times V_{DAC} - 2.52 \times V_{OFFS_IN}$$

AD5532-2:

$$V_{OUT} = 7 \times V_{DAC} - 6 \times V_{OFFS_IN}$$

V_{DAC} is the output of the DAC.

V_{OFFS_IN} is the voltage at the OFFS_IN pin.

The following table shows how the output range on V_{OUT} relates to the offset voltage supplied by the user.

Table 8. Sample Output Voltage Ranges

| V_{OFFS_IN} (V) | V_{DAC} (V) | V_{OUT} (AD5532-1/-3/-5) | V_{OUT} (AD5532-2) |
|-----------------------|------------------|-------------------------------|-------------------------|
| 0.5 | 0.05 to 3 | –1.26 to +9.3 | Headroom limited |
| 1 | 0.05 to 3 | –2.52 to +8.04 | –6 to +15 |

V_{OUT} is limited only by the headroom of the output amplifiers. V_{OUT} must be within maximum ratings.

OFFSET VOLTAGE CHANNEL

The offset voltage can be externally supplied by the user at OFFS_IN or it can be supplied by an additional offset voltage channel on the device itself. The offset can be set up in two ways. In ISHA mode, the required offset voltage is set up on V_{IN} and acquired by the offset channel. In DAC mode, the code corresponding to the offset value is loaded directly into the offset DAC. This offset channel's DAC output is directly connected to OFFS_OUT. By connecting OFFS_OUT to

OFFS_IN this offset voltage can be used as the offset voltage for the 32 output amplifiers. It is important to choose the offset so that V_{OUT} is within maximum ratings.

RESET FUNCTION

The reset function on the AD5532 can be used to reset all nodes on this device to their power-on reset condition. This is implemented by applying a low-going pulse of between 90 ns and 200 ns to the TRACK/RESET pin on the device. If the applied pulse is less than 90 ns, it is assumed to be a glitch and no operation takes place. If the applied pulse is wider than 200 ns, this pin adopts its track function on the selected channel, V_{IN} is switched to the output buffer, and an acquisition on the channel does not occur until a rising edge of TRACK.

ISHA MODE

In ISHA mode, the input voltage V_{IN} is sampled and converted into a digital word. The noninverting input to the output buffer (gain and offset stage) is tied to V_{IN} during the acquisition period to avoid spurious outputs, while the DAC acquires the correct code. This is completed in 16 μs max. The updated DAC output then assumes control of the output voltage. The output voltage of the DAC is connected to the noninverting input of the output buffer. Because the channel output voltage is effectively the output of a DAC, there is no droop associated with it. As long as power is maintained to the device, the output voltage is constant until this channel is addressed again. Because the internal DACs are offset by 70 mV (max) from GND, the minimum V_{IN} in ISHA mode is 70 mV. The maximum V_{IN} is 2.96 V due to the upper dead band of 40 mV (max).

ANALOG INPUT (ISHA MODE)

Figure 19 shows the equivalent analog input circuit. The Capacitor C1 is typically 20 pF and can be attributed to pin capacitance and 32 off-channels. When a channel is selected, an extra 7.5 pF (typ) is switched in. This Capacitor C2 is charged to the previously acquired voltage on that particular channel so it must charge/discharge to the new level. The external source must be able to charge/discharge this additional capacitance within 1 μs –2 μs of channel selection so that V_{IN} can be acquired accurately. Thus, a low impedance source is suggested.

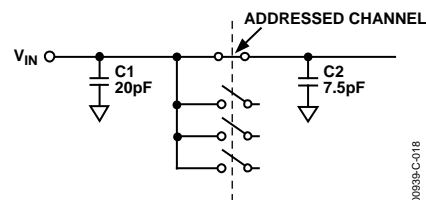

Figure 19. Analog Input Circuit

Large source impedances significantly affect the performance of the ADC. An input buffer amplifier may be required.

TRACK FUNCTION (ISHA MODE)

Typically in ISHA mode of operation $\overline{\text{TRACK}}$ is held high and the channel begins to acquire when it is addressed. However, if $\overline{\text{TRACK}}$ is low when the channel is addressed, V_{IN} is switched to the output buffer and an acquisition on the channel does not occur until a rising edge of $\overline{\text{TRACK}}$. At this stage, the $\overline{\text{BUSY}}$ pin goes low until the acquisition is complete, at which point the DAC assumes control of the voltage to the output buffer and V_{IN} is free to change again without affecting this output value.

This is useful in an application where the user wants to ramp up V_{IN} until V_{OUT} reaches a particular level (see Figure 20). V_{IN} does not need to be acquired continuously while it is ramping up. $\overline{\text{TRACK}}$ can be kept low and only when V_{OUT} has reached its desired voltage is $\overline{\text{TRACK}}$ brought high. At this stage, the acquisition of V_{IN} begins.

In the example shown, a desired voltage is required on the output of the pin driver. This voltage is represented by one input to a comparator. The microcontroller/microprocessor ramps up the input voltage on V_{IN} through a DAC. $\overline{\text{TRACK}}$ is kept low while the voltage on V_{IN} ramps up so that V_{IN} is not continually acquired. When the desired voltage is reached on the output of the pin driver, the comparator output switches. The $\mu\text{C}/\mu\text{P}$ then knows what code is required to be input to obtain the desired voltage at the DUT. The $\overline{\text{TRACK}}$ input is now brought high and the part begins to acquire V_{IN} . At this stage $\overline{\text{BUSY}}$ goes low until V_{IN} has been acquired. The output buffer is then switched from V_{IN} to the output of the DAC.

MODES OF OPERATION

The AD5532 can be used in four different modes of operation. These modes are set by two mode bits, the first two bits in the serial word.

Table 9. Modes of Operation

| Mode Bit 1 | Mode Bit 2 | Operating Mode |
|------------|------------|-----------------------|
| 0 | 0 | ISHA mode |
| 0 | 1 | DAC mode |
| 1 | 0 | Acquire and Read Back |
| 1 | 1 | Read Back |

1. ISHA Mode

In this mode, a channel is addressed and that channel acquires the voltage on V_{IN} . This mode requires a 10-bit write (see Figure 21a) to address the relevant channel ($V_{\text{OUT}0}$ – $V_{\text{OUT}31}$, offset channel or all channels). MSB is written first.

2. DAC Mode

In this standard mode, a selected DAC register is loaded serially. This requires a 24-bit write (10 bits to address the relevant DAC plus an extra 14 bits of DAC data). MSB is written first. The user must allow 400 ns (min) between successive writes in DAC mode.

3. Acquire and Readback Mode

This mode allows the user to acquire V_{IN} and read back the data in a particular DAC register. The relevant channel is addressed (10-bit write, MSB first) and V_{IN} is acquired in 16 μs (max). Following the acquisition, after the next falling edge of $\overline{\text{SYNC}}$, the data in the relevant DAC register is clocked out onto the D_{OUT} line in a 14-bit serial format. The full acquisition time must elapse before the DAC register data can be clocked out.

4. Readback Mode

Again, this is a Readback mode but no acquisition is performed. The relevant channel is addressed (10-bit write, MSB first) and on the next falling edge of $\overline{\text{SYNC}}$, the data in the relevant DAC register is clocked out onto the D_{OUT} line in a 14-bit serial format. The user must allow 400 ns (min) between the last $\overline{\text{SCLK}}$ falling edge in the 10-bit write and the falling edge of $\overline{\text{SYNC}}$ in the 14-bit read back. The serial write and read words can be seen in Figure 21.

This feature allows the user to read back the DAC register code of any of the channels. In DAC mode, this is useful in verification of write cycles. In ISHA mode, readback is useful if the system has been calibrated and the user wants to know what code in the DAC corresponds to a desired voltage on V_{OUT} . If this voltage is required again, the user can input the code directly to the DAC register without going through the acquisition sequence.

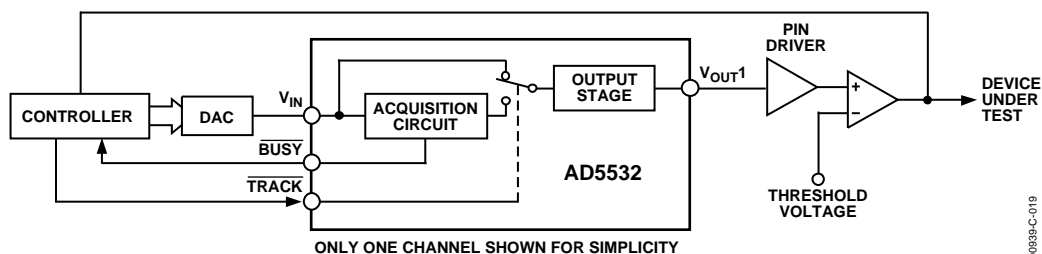

Figure 20. Typical ATE Circuit Using $\overline{\text{TRACK}}$ Input

SERIAL INTERFACE

The serial interface allows easy interfacing to most micro-controllers and DSPs, such as the PIC16C, PIC17C, QSPI, SPI, DSP56000, TMS320, and ADSP-21xx, without the need for any glue logic. When interfacing to the 8051, the SCLK must be inverted. The Microprocessor Interfacing section explains how to interface to some popular DSPs and microcontrollers. Figure 4, Figure 5, and Figure 6 show the timing diagram for a serial read and write to the AD5532. The serial interface works with both a continuous and a noncontinuous serial clock. The first falling edge of SYNC resets a counter that counts the number of serial clocks to ensure the correct number of bits are shifted in and out of the serial shift registers. Any further edges on SYNC are ignored until the correct number of bits are shifted in or out. Once the correct number of bits for the selected mode has been shifted in or out, the SCLK is ignored. In order for another serial transfer to take place the counter must be reset by the falling edge of SYNC.

In readback, the first rising SCLK edge after the falling edge of SYNC causes D_{OUT} to leave its high impedance state and data is clocked out onto the D_{OUT} line and also on subsequent SCLK rising edges. The D_{OUT} pin goes back into a high impedance state on the falling edge of the 14th SCLK. Data on the D_{IN} line is latched in on the first SCLK falling edge after the falling edge of the SYNC signal and on subsequent SCLK falling edges. During read-back D_{IN} is ignored. The serial interface does

not shift data in or out until it receives the falling edge of the SYNC signal.

Table 10

| Pin | Description |
|------------------------------|--|
| SER/PAR | This pin is tied high to enable the serial interface and to disable the parallel interface. The serial interface is controlled by the four pins that follow. |
| SYNC, D _{IN} , SCLK | Standard 3-wire interface pins. The SYNC pin is shared with the CS function of the parallel interface. |
| D _{OUT} | Data Out pin for reading back the contents of the DAC registers. The data is clocked out on the rising edge of SCLK and is valid on the falling edge of SCLK. |
| Mode Bits | The four different modes of operation are described in the Modes of Operation section. |
| Cal Bit | In DAC mode, this is a test bit. When high, it loads all 0s or all 1s to the 32 DACs simultaneously. In ISHA mode, all 32 channels acquire V _{IN} at the same time when this bit is high. In ISHA mode, the acquisition time is then 45 μs (typ) and accuracy may be reduced. This bit is set low for normal use. |
| Offset Sel Bit | If this is set high, the offset channel is selected and Bits A4–A0 are ignored. |
| Test Bit | Must be set low for correct operation of the part. |
| A4–A0 | Used to address any one of the 32 channels (A4 = MSB of address, A0 = LSB). |
| DB13–DB0 | Used to write a 14-bit word into the addressed DAC register. Only valid when in DAC mode. |

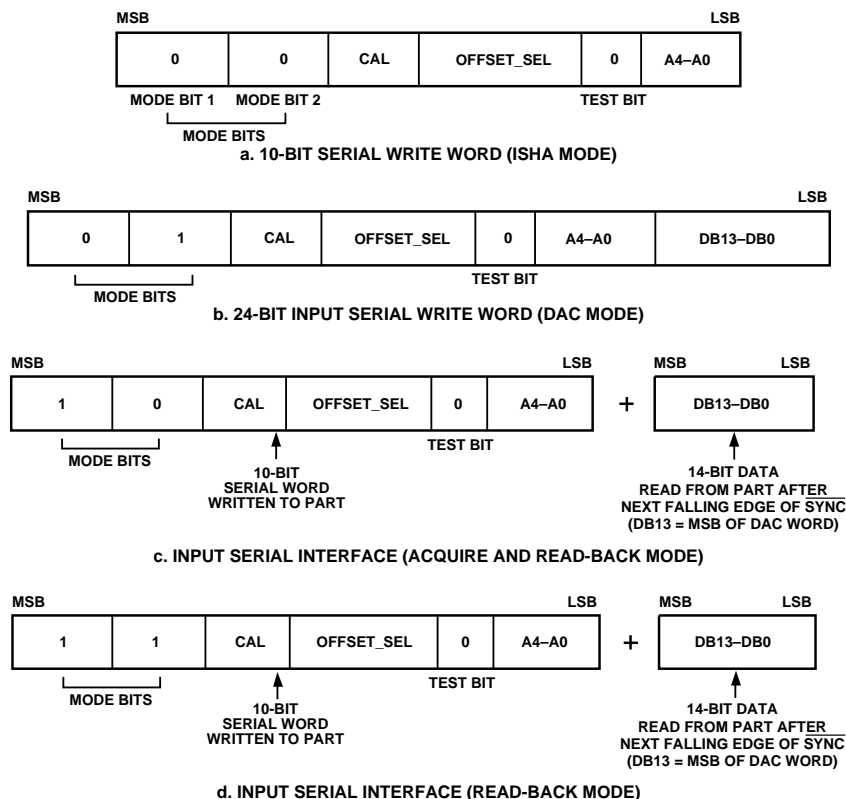

Figure 21. Serial Interface Formats

00598-C-020

PARALLEL INTERFACE (ISHA MODE ONLY)

The SER/ $\overline{\text{PAR}}$ bit must be tied low to enable the parallel interface and disable the serial interface. The parallel interface is controlled by nine pins, as described in Table 11.

Table 11.

| Pin | Description |
|------------------------|--|
| $\overline{\text{CS}}$ | Active low package select pin. This pin is shared with the $\overline{\text{SYNC}}$ function for the serial interface. |
| $\overline{\text{WR}}$ | Active low write pin. The values on the address pins are latched on a rising edge of $\overline{\text{WR}}$. |
| A4–A0 | Five address pins (A4 = MSB of address, A0 = LSB). These are used to address the relevant channel (out of a possible 32). |
| OFFSET_SEL | Offset select pin. This has the same function as the Offset_Sel bit in the serial interface. When it is high, the offset channel is addressed. The address on A4–A0 is ignored in this case. |
| CAL | When this pin is high, all 32 channels acquire VIN simultaneously. The acquisition time is then 45 μs (typ) and accuracy may be reduced. |

MICROPROCESSOR INTERFACING

AD5532 to ADSP-21xx Interface

ADSP-21xx DSPs are easily interfaced to the AD5532 without the need for extra logic.

A data transfer is initiated by writing a word to the TX register after the SPORT has been enabled. In a write sequence, data is clocked out on each rising edge of the DSP serial clock and clocked into the AD5532 on the falling edge of its SCLK. In readback, 16 bits of data are clocked out of the AD5532 on each rising edge of SCLK and clocked into the DSP on the rising edge of SCLK. D_{IN} is ignored. The valid 14 bits of data is centered in the 16-bit RX register in this configuration. The SPORT Control register should be set up as in Table 12.

Table 12.

| | |
|---------------------|--|
| TFSW = RFSW = 1 | Alternate framing |
| INVRFS = INVTFS = 1 | Active low frame signal |
| DTYPE = 00 | Right justify data |
| ISCLK = 1 | Internal serial clock |
| TFSR = RFSR = 1 | Frame every word |
| IRFS = 0 | External framing signal |
| ITFS = 1 | Internal framing signal |
| SLEN = 1001 | 10-bit data-words (ISHA mode write) |
| SLEN = 0111 | 3 \times 8-bit data-words (DAC mode write) |
| SLEN = 1111 | 16-bit data-words (Readback mode) |

Figure 22 shows the connection diagram.

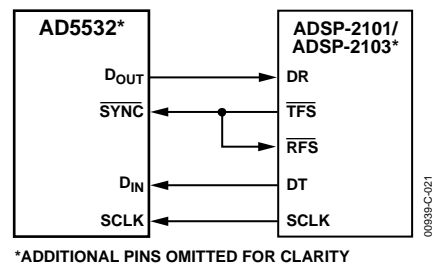

*ADDITIONAL PINS OMITTED FOR CLARITY

Figure 22. AD5532 to ADSP-2101/ADSP-2103 Interface

AD5532 to MC68HC11

The serial peripheral interface (SPI) on the MC68HC11 is configured for master mode (MSTR) = 1, clock polarity bit (CPOL) = 0, and the clock phase bit (CPHA) = 1. The SPI is configured by writing to the SPI control register (SPCR)—see the *68HC11 User Manual*. SCK of the 68HC11 drives the SCLK of the AD5532, the MOSI output drives the serial data line (D_{IN}) of the AD5532, and the MISO input is driven from D_{OUT} . The $\overline{\text{SYNC}}$ signal is derived from a port line (PC7). When data is being transmitted to the AD5532, the $\overline{\text{SYNC}}$ line is taken low (PC7). Data appearing on the MOSI output is valid on the falling edge of SCK. Serial data from the 68HC11 is transmitted in 8-bit bytes with only eight falling clock edges occurring in the transmit cycle. Data is transmitted MSB first. To transmit 10 data bits in ISHA mode, it is important to left-justify the data in the SPDR register. PC7 must be pulled low to start a transfer. It is taken high and pulled low again before other read/write cycles can take place. Figure 23 shows a connection diagram.

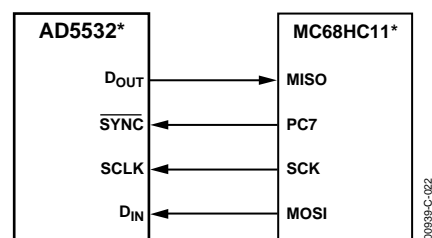

*ADDITIONAL PINS OMITTED FOR CLARITY

Figure 23. AD5532 to MC68HC11 Interface

AD5532

AD5532 to PIC16C6x/7x

The PIC16C6x/7x synchronous serial port (SSP) is configured as an SPI master with the Clock Polarity Bit = 0. This is done by writing to the synchronous serial port control register (SSPCON). See the *PIC16/17 Microcontroller User Manual*. In this example, the I/O port RA1 is being used to pulse SYNC and enable the serial port of the AD5532. This microcontroller transfers only eight bits of data during each serial transfer operation; therefore, two or three consecutive read/write operations are needed depending on the mode. Figure 24 shows the connection diagram.

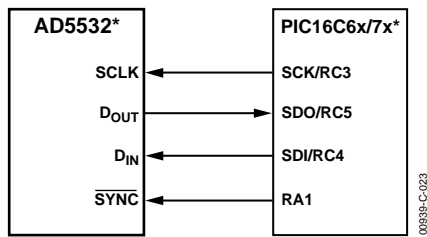

Figure 24. AD5532 to PIC16C6x/7x Interface

AD5532 to 8051

The AD5532 requires a clock synchronized to the serial data. The 8051 serial interface must therefore be operated in Mode 0. In this mode, serial data enters and exits through RxD and a shift clock is output on TxD. Figure 25 shows how the 8051 is connected to the AD5532. Because the AD5532 shifts data out on the rising edge of the shift clock and latches data in on the falling edge, the shift clock must be inverted. The AD5532 requires its data with the MSB first. Because the 8051 outputs the LSB first, the transmit routine must take this into account.

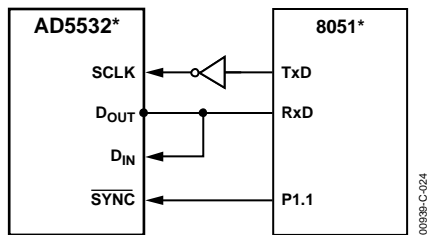

Figure 25. AD5532 to 8051 Interface

APPLICATION CIRCUITS

AD5532 in a Typical ATE System

The AD5532 is ideally suited for use in automatic test equipment. Several DACs are required to control pin drivers, comparators, active loads, and signal timing. Traditionally, sample-and-hold devices were used in this application.

The AD5532 has several advantages: no refreshing is required, there is no droop, pedestal error is eliminated, and there is no need for extra filtering to remove glitches. Overall a higher level of integration is achieved in a smaller area (see Figure 26).

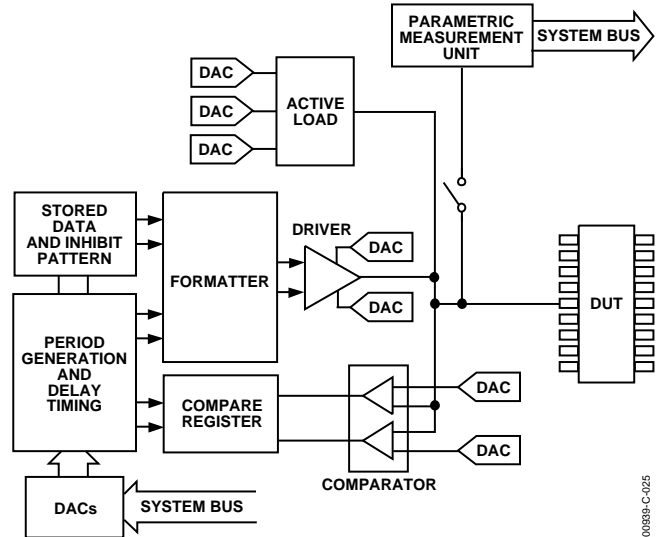

Figure 26. AD5532 in an ATE System

Typical Application Circuit (DAC Mode)

The AD5532 can be used in many optical networking applications that require a large number of DACs to perform control and measurement functions. In the example shown in Figure 27, the outputs of the AD5532 are amplified and used to control actuators that determine the position of MEMS mirrors in an optical switch. The exact position of each mirror is measured using sensors. The sensor readings are muxed using four dual, 4-channel matrix switches (ADG739) and fed back to an 8-channel, 14-bit ADC (AD7856).

The control loop is driven by an ADSP-2191M, a 16-bit fixed-point DSP with 3 SPORT interfaces and 2 SPI ports. The DSP uses some of these serial ports to write data to the DAC, control the multiplexer, and read back data from the ADC.

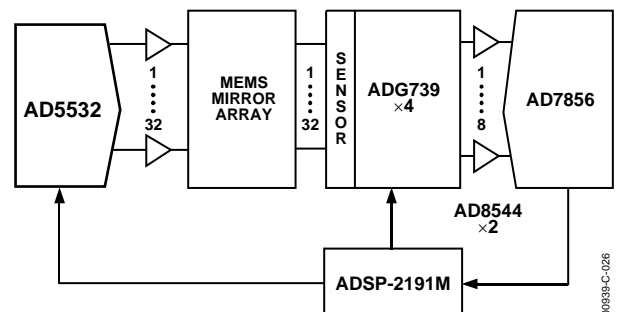

Figure 27. Typical Optical Control and Measurement Application Circuit

Typical Application Circuit (ISHA Mode)

The AD5532 can be used to set up voltage levels on 32 channels as shown in the circuit that follows. An AD780 provides the 3 V reference for the AD5532 and for the AD5541 16-bit DAC. A simple 3-wire interface is used to write to the AD5541. Because the AD5541 has an output resistance of 6.25 k Ω (typ), the time taken to charge/discharge the capacitance at the V_{IN} pin is significant. Hence an AD820 is used to buffer the DAC output. Note that it is important to minimize noise on V_{IN} and REF_{IN} when laying out the circuit.

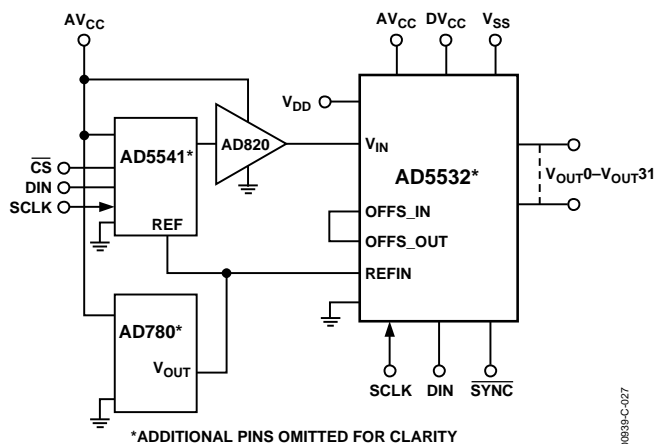

Figure 28. Typical Application Circuit (ISHA Mode)

POWER SUPPLY DECOUPLING

In any circuit where accuracy is important, careful consideration of the power supply and ground return layout helps to ensure the rated performance. The printed circuit board on which the AD5532 is mounted should be designed so that the analog and digital sections are separated and confined to certain areas of the board. If the AD5532 is in a system where multiple devices require an AGND-to-DGND connection, the connection should be made at one point only. The star ground point should be established as close as possible to the device. For supplies with multiple pins (V_{SS} , V_{DD} , AV_{CC}) it is recommended to tie those pins together. The AD5532 should have ample supply bypassing of 10 μF in parallel with 0.1 μF on each supply located as close to the package as possible, ideally right up against the device. The 10 μF capacitors are the tantalum bead type. The 0.1 μF capacitor should have low effective series resistance (ESR) and effective series inductance (ESI), such as the common ceramic types that provide a low impedance path to ground at high frequencies, to handle transient currents due to internal logic switching.

The power supply lines of the AD5532 should use as large a trace as possible to provide low impedance paths and reduce the effects of glitches on the power supply line. Fast switching signals, such as clocks, should be shielded with digital ground to avoid radiating noise to other parts of the board and should never be run near the reference inputs. A ground line routed between the D_{IN} and SCLK lines helps reduce crosstalk between them (not required on a multilayer board as there is a separate ground plane, but separating the lines helps).

Note it is essential to minimize noise on V_{IN} and REF_{IN} lines. Particularly for optimum ISHA performance, the V_{IN} line must be kept noise free. Depending on the noise performance of the board, a noise filtering capacitor may be required on the V_{IN} line. If this capacitor is necessary, then for optimum throughput it may be necessary to buffer the source which is driving V_{IN} . Avoid crossover of digital and analog signals. Traces on opposite sides of the board should run at right angles to each other. This reduces the effects of feedthrough through the board. A micro-strip technique is by far the best, but not always possible with a double-sided board. In this technique, the component side of the board is dedicated to ground plane while signal traces are placed on the solder side.

As is the case for all thin packages, care must be taken to avoid flexing the package and to avoid a point load on the surface of the package during the assembly process.

Компания «Life Electronics» занимается поставками электронных компонентов импортного и отечественного производства от производителей и со складов крупных дистрибьюторов Европы, Америки и Азии.

С конца 2013 года компания активно расширяет линейку поставок компонентов по направлению коаксиальный кабель, кварцевые генераторы и конденсаторы (керамические, пленочные, электролитические), за счёт заключения дистрибьюторских договоров

Мы предлагаем:

- Конкуренеспособные цены и скидки постоянным клиентам.
- Специальные условия для постоянных клиентов.
- Подбор аналогов.
- Поставку компонентов в любых объемах, удовлетворяющих вашим потребностям.
- Приемлемые сроки поставки, возможна ускоренная поставка.
- Доставку товара в любую точку России и стран СНГ.
- Комплексную поставку.
- Работу по проектам и поставку образцов.
- Формирование склада под заказчика.
- Сертификаты соответствия на поставляемую продукцию (по желанию клиента).
- Тестирование поставляемой продукции.
- Поставку компонентов, требующих военную и космическую приемку.
- Входной контроль качества.
- Наличие сертификата ISO.

В составе нашей компании организован Конструкторский отдел, призванный помогать разработчикам, и инженерам.

Конструкторский отдел помогает осуществить:

- Регистрацию проекта у производителя компонентов.
- Техническую поддержку проекта.
- Защиту от снятия компонента с производства.
- Оценку стоимости проекта по компонентам.
- Изготовление тестовой платы монтаж и пусконаладочные работы.



Тел: +7 (812) 336 43 04 (многоканальный)

Email: org@lifeelectronics.ru